

# EGA Master

## ART IN INNOVATION

BE SAFE...BE EFFICIENT

# SAFETY TOOLS



1000V



ESD



DROPS



N-S 1000V



NON-SPARKING



UNDERWATER



ATEX



TITANIUM



INOX



PPE



Este documento ha sido creado por EGA Master y a ella le corresponden todos sus derechos. Queda prohibida por tanto toda copia o redifusión de la totalidad o parte de este documento, tanto en soporte físico, electrónico o salvo expresa autorización de EGA Master. Cualquier vulneración de estos derechos podrá ser reclamada vía judicial.

This document has been created by and is the property of EGA Master. Thus, all intellectual rights belong to EGA Master. Any total or partial copy of this document in any physical, electronic or any other form is strictly forbidden. EGA Master will legally proceed against any infringement of these rights.

Ce document a été créé par EGA Master et tous ses droits lui correspondent. Par conséquent, sauf autorisation préalable d'EGA Master, toute copie ou diffusion intégrale ou partielle de ce document, soit en support physique ou électronique est interdite. Toute violation de ces droits pourra être réclamée par voie judiciaire.

Miembro de / Member of / Membre de :



HEGAN - Basque Aerospace Cluster [www.hegan.com](http://www.hegan.com)



Asociación Española de Equipos, Soluciones y Tecnologías de Proceso en la Manipulación de Fluidos  
Spanish Association of Equipment, Solutions and Process Technologies in Fluid Handling  
Association Espagnole des Équipements, Solutions et Technologies de Traitement des Fluides  
[www.fluidexspain.com](http://www.fluidexspain.com)



Federación de Fabricantes Exportadores de Artículos de Ferretería  
Spanish Hardware Manufacturers Federation  
Fédération Espagnole de Fabricants Exportateurs d'Articles de Quincaillerie  
[www.cofearfe.com](http://www.cofearfe.com)



Foro de Marcas Líderes Renombradas Españolas  
Leading Brands of Spain Forum  
Forum des Marques de Renom Espagnoles  
[www.brandsofspain.com](http://www.brandsofspain.com)  
[www.marcasrenombradas.com](http://www.marcasrenombradas.com)



Fundación Vasca para la Calidad  
Basque Foundation for Quality  
Fondation Basque pour la Qualité  
[www.euskalit.net](http://www.euskalit.net)



Red Vasca de Ciencia Tecnología e Innovación  
Agency of Innovation  
Agence Basque de L'innovation  
[www.innobasque.com](http://www.innobasque.com)



Club de Exportadores e Inversores Españoles  
Spanish Exporters and Investors Club  
Club des Exportateurs et Investisseurs Espagnols  
[www.clubexportadores.org](http://www.clubexportadores.org)



Iniciativa Global Drops para la prevención de caída de objetos  
The dropped objects prevention scheme global resource centre  
Initiative globale Drops de la prévention de chute d'objets  
[www.dropsonline.org](http://www.dropsonline.org)



Agrupación de Industrias Marítimas de Euskadi  
Association of Maritime Industries of the Basque Country  
Association des Industries Maritimes Basques  
[www.adimde.es](http://www.adimde.es)



Sindicato Empresarial Alavés  
Employer Federation of Alava  
Syndicat des Employés d'Alava  
[sie.sea.es](http://sie.sea.es)



Miembro del Foro Club de la Cámara de Comercio e Industria de Álava  
Chamber of Commerce of Alava  
Chambre de Commerce d'Alava  
[www.camaradealava.com](http://www.camaradealava.com)



Asociación para el Progreso de la Dirección  
Association for Progress in Management  
Association pour le Progrès dans le Management  
[www.apd.es](http://www.apd.es)



Fundación Iberoamericana para la Calidad  
Foundation for Quality  
Fondation Ibero-Américaine pour la Gestion de la Qualité  
[www.fundibeq.org](http://www.fundibeq.org)



Asociación de Centros de Excelencia a Nivel Nacional  
Association of Centers of Excellence  
Association de Centres d'Excellence à Niveau National  
[www.centrosdeexcelencia.com](http://www.centrosdeexcelencia.com)



Red Pacto Mundial España  
Asociación Española del Pacto Mundial Un Global Compact  
Un Global Compact  
Association Espagnole du Pacte Mondial Un Global Compact  
[www.pactomundial.org](http://www.pactomundial.org)



Asociación Sectorial de Equipos, Componentes y Servicios de Energías Renovables  
Energy Supply Chain  
Association Sectorielle des Équipements, Composants et Services des Énergies Renouvelables  
[www.eschain.com](http://www.eschain.com)

Presentado como ejemplo por:

- Comisión Europea
- Diputación Foral de Álava
- Diputación Foral de Bizkaia
- Universidad del País Vasco
- Congreso Internacional de Managing
- V Jornadas de Innovación en Gestión (Bilbao)
- Universidad de Strathclyde de Escocia
- Foro de Empresas Avanzadas en Gestión del Cluster del Conocimiento
- Universidad Autónoma de Madrid
- Forum Europa
- Club de Marketing de la Rioja
- Euskalit- Fundación Vasca para la Calidad
- CETIC -Centro de Tecnologías de la Información y la Comunicación
- Escuelas de Negocios IESE (España), INSEAD (Francia) y WHU (Alemania)
- Universidad de Boise EEUU
- Innobasque, Agencia Vasca de Innovación
- Fundación ICIL
- Universidad de Deusto
- SEA - Empresarios Alaveses
- Gobierno Vasco (SPRI)
- Ministerio de Industria (Círculo Bellas Artes)
- Fundación Navarra para la Excelencia
- Universidad de Navarra
- CFL (Dinamarca)
- Asociación para el Progreso de la Dirección (APD)
- Universidad Adolfo Ibañez (Chile)

Presented as an example by:

- European Commission
- Provincial Government of Alava
- Provincial Government of Bizkaia
- University of the Basque Country
- International Management Congress
- 5th Meeting of Innovation in Management (Bilbao)
- University of Strathclyde (Scotland)
- Forum of Companies Advanced in Management of the Cluster of Knowledge
- Autonomous University of Madrid
- Forum Europa
- Marketing Club of Rioja
- Euskalit- Basque Foundation for Quality
- CETIC- Center of Information and Communication Technologies
- IESE (Spain), INSEAD (France) and WHU (Germany) Business Schools
- Boise University EEUU
- Innobasque, Basque Innovation Agency
- ICIL Foundation
- Deusto University
- SEA - Entrepreneurs of Alava
- Basque Government (SPRI)
- Ministry of Industry
- Navarra Foundation for Excellence
- University of Navarra
- Center for Ledesle, CFL (Denmark)
- Association for Progress in Management (APD)
- Adolfo Ibañez University (Chile)

Présenté comme exemple pour:

- Commission Européenne
- Députation d'Alava
- Députation de Biscaye
- Université du Pays Basque
- Congrès International du Management
- V Journées de l'Innovation dans la Gestion (Bilbao)
- Université de Strathclyde de l'Ecosse
- Forum des Entreprises Avancées en Gestion du Cluster des Connaissances
- Université Autonome de Madrid
- Forum Europe
- Marketing Club de la Rioja
- Euskalit- Fondation Basque pour la Qualité
- CETIC- Centre de Technologies de l'Information et de la Communication
- Écoles Supérieures de Commerce IESE (Espagne), INSEAD (France) et WHU (Allemagne)
- Université de Boise, EEUU
- Innobasque, Agence Basque pour l'Innovation
- Fondation ICIL
- Université de Deusto
- SEA - Entrepreneurs d'Alava
- Gouvernement Basque (SPRI)
- Ministère d'Industrie (Cercle de Beux-Arts)
- Fondation Navarre pour l'Excellence
- Université de Navarre
- CFL (Danemark)
- Association pour le Progrès dans le Management (APD)
- Université Adolfo Ibañez (Chili)

**LA MÁS GALARDONADA**  
**THE MOST AWARDED**  
**LA PLUS PRIMÉE**

	<b>Producto Más Innovador (Feria NSC de Seguridad, San Diego, EEUU, 2019)</b> <i>"Best in Show" New Product Showcase Awards (National Safety Council 2019 Congress &amp; Expo, San Diego, USA)</i> Produit le plus innovateur (Salón NSC de Sécurité, San Diego, EUA, 2019)		<b>Premio al Producto Más Innovador, Ferroforma 2013</b> <i>Award to the Most Innovative Industrial Product, Ferroforma 2013</i> Prix au Produit le Plus Innovateur, Ferroforma 2013
	<b>Premio Banco Santander a la empresa del año, 2019</b> <i>Banco Santander Award to the Company, 2019</i> Prix Banco Santander à l'entreprise de l'année, 2019		<b>Certificado de Calidad BIKAIN, 2013</b> <i>BIKAIN certificate, 2013</i> Certificat de qualité BIKAIN, 2013
	<b>International Quality Innovation Award, Beijing 2019</b> <i>International Quality Innovation Award, Beijing 2019</i> International Quality Innovation Award, Beijing 2019		<b>Ruban d'Honneur, European Business Awards 2012/13</b> <i>Ruban d'Honneur, European Business Awards 2012/13</i> Ruban d'Honneur, European Business Awards 2012/13
	<b>Quality Innovation Award, Euskalit 2018</b> <i>Quality Innovation Award, Euskalit 2018</i> Quality Innovation Award, Euskalit 2018		<b>Premio Internacional al Mejor Modelo de Negocio, 2012</b> <i>International Award by Development Systems to the Best Business Model, 2012</i> Prix International au Meilleur Modèle d'Entreprise, 2012
	<b>Premio Confebask, Mejor Instructor, 2018</b> <i>Confebask Award, Best Instructor, 2018</i> Prix Confebask, Meilleur Instructeur, 2018		<b>Premio a la Internacionalización, Club de Exportadores e Inversores, 2011</b> <i>Internationalization Award by The Spanish Exporters and Investors Club, 2011</i> Prix de l'internationalisation, Club des Exportateurs et Investisseurs, 2011
	<b>Premio Pacto Verde a las buenas prácticas medioambientales, 2018</b> <i>Green Pact Award for good environmental practices, 2018</i> Prix Pacte Vert aux bonnes pratiques environnementales, 2018		<b>Premio Finalista en Innovación CEX Asociación Española de Centros de la Excelencia, 2011</b> <i>Finalist Award for Best Practice in Innovation 2011, by CEX Spanish Association of Centers of Excellence</i> Prix Finaliste en Innovation CEX Association Espagnole des Centres d'Excellence, 2011
	<b>Empresa del año 2018, El Correo - Banco Sabadell</b> <i>Company of the year 2018, El Correo - Banco Sabadell</i> Entreprise de l'année 2018, El Correo - Banco Sabadell		<b>Premio Nacional al Relevo Generacional, 2010</b> <i>Company Succession National Award, 2010</i> Prix national a la relève générationnel, 2010
	<b>Premio a la Innovación Industrial Vodafone-Deia, 2017</b> <i>Vodafone-Deia Industrial Innovation Award, 2017</i> Pris de l'innovation industrielle Vodafone-Deia 2017		<b>Premio Iberoamericano de la Calidad y Excelencia 2010, Premio Oro</b> <i>Iberoamerican Award for Quality Management &amp; Excellence 2010</i> Prix Ibéro-américain de la Qualité et l'Excellence 2010, Prix d'Or
	<b>Premio BANKIA-ACOCEx a la Trayectoria Internacional, 2016</b> <i>International Business Award BANKIA-ACOCEx, 2016</i> Prix BANKIA ACOCEX pour son Parcours International, 2016		<b>Medalla de Oro por la Oficina Nacional de la Normalización de Cuba, 2010</b> <i>Gold Medal, National Office of Standards and Normalization of Cuba, 2010</i> Médaille d'Or par le Bureau National de la Normalisation de Cuba, 2010
	<b>Quality Innovation Award, Euskalit 2016</b> <i>Quality Innovation Award, Euskalit 2016</i> Quality Innovation Award, Euskalit 2016		<b>Premio Dato de Oro a la Empresa Solidaria, 2010</b> <i>"Dato de Oro" Award on Corporate Social Responsibility, 2010</i> Prix Dato d'Or à l'Entreprise Solidaire, 2010
	<b>Sello Pyme Innovadora del Ministerio Español de Economía y Competitividad, 2016</b> <i>Innovative SME Stamp from the Spanish Ministry of Economy and Competitiveness, 2016</i> Label de la PME Innovatrice du Ministère Espagnole de l'Economie et de Compétitivité, 2016		<b>Premio Europeo a la Mejor Práctica de Innovación, Foro EFQM 2010</b> <i>European Award to the Best Practice in Innovation, by the EFQM Forum, 2010</i> Prix Européen à la Meilleure Pratique d'Innovation, Forum EFQM 2010
	<b>Premio Juan José Azurmendi a la Trayectoria Empresarial, 2014</b> <i>Employers Federation Award for a Lifelong Entrepreneurial Achievement, 2014</i> Prix Juan José Azurmendi à la Trajectoire Entrepreneuriale, 2014		<b>Premio Finalista a la Excelencia Industrial por IESE (España), INSEAD (Francia) y WHU (Alemania), 2010</b> <i>Industrial Excellence Finalist Award by IESE (Spain), INSEAD (France) and WHU (Germany) Business Schools, 2010</i> Prix finaliste à l'Excellence Industrielle attribué par IESE (Espagne), INSEAD (France) et WHU (Allemagne), 2010
	<b>Premio Lazarraga, 2014</b> <i>Basque Language Award, 2014</i> Prix de la Langue Basque, 2014		
	<b>OHSAS 18001, 2014</b> <i>OHSAS 18001, 2014</i> OHSAS 18001, 2014		<b>Premio Gran Emprendedor, 2010</b> <i>Great Entrepreneur Award for the Founder and Chairman of EGA Master, 2010</i> Prix Grand Entrepreneur, 2010
	<b>Certificado Bai Euskarari, 2014</b> <i>Linguistic Certification, 2014</i> Certification Linguistique, 2014		<b>Premio I+D+i en Herramientas de Seguridad, 2010</b> <i>R&amp;D Award for Safety Tools, 2010</i> Prix R&D+i pour les Outils de Sécurité, 2010
	<b>Premio a la Internacionalización de la Cámara de Comercio de Álava, 2013</b> <i>Internationalization Award, Chamber of Commerce, 2013</i> Prix à l'Internationalisation de la Chambre de Commerce d'Alava, 2013		<b>Q de Oro EFQM, 2009</b> <i>EFQM Golden Q Award, 2009</i> Q d'Or EFQM, 2009
	<b>Premio a la Internacionalización de IE Business School e Iberinform, 2013</b> <i>International Business Award 2013 by IE Business School, 2013</i> Prix à l'Internationalisation de IE Business School et Iberinform, 2013		<b>Premio Human a la Estrategia Basada en Personas, 2009</b> <i>Human Award for its Strategy Based on People, 2009</i> Prix Human pour la Stratégie Basée sur les Personnes, 2009

	<b>Premio ICIL a la Excelencia Logística, 2009</b> ICIL Award to Excellence in Logistics, 2009 Prix ICIL à l'Excellence en Logistique, 2009		<b>Premio a la Mejor Idea en Herramientas del Club de Inventores Españoles, 2007</b> Best Tool Award by "Spanish Inventor's Club", 2007 Prix à la Meilleure Idée en Outillage du Club des Inventeurs Espagnols, 2007
	<b>Premio Finalista a la Mejor Web Corporativa, 2009</b> Finalist Award to the Best Company Website, March 2009 Prix Finaliste au Meilleur Site Web Corporatif, 2009		<b>Medalla de Oro a la Calidad de la Oficina Nacional de la Normalización de Cuba, 2006</b> Gold Medal, National Office of Standards and Normalization of Cuba 2006 Médaille d'Or à la Qualité du Bureau National de la Normalisation de Cuba, 2006
	<b>ISO 9001:2008, 2009</b> ISO 9001:2008, 2009 ISO 9001-2008, 2009		<b>Premio al Mejor Diseño de la Oficina Nacional de Diseño Industrial de Cuba a la Llave Vasca, 2006</b> Best Design Award, National Office of Industrial Design of Cuba, 2006 Prix du Meilleur Dessin du Bureau National de Dessin Industriel de Cuba pour la Clé Basque, 2006
	<b>Premio Príncipe Felipe a la Excelencia en Competitividad Empresarial, 2008</b> Príncipe Felipe Award to Corporate Excellence in Competitiveness, 2008 Prix Príncipe Felipe à l'Excellence en Compétitivité Entrepreneuriale, 2008		<b>Premio Finalista Príncipe Felipe a la Excelencia Empresarial, 2005</b> Prince Felipe Finalist Award to Corporate Excellence, 2005 Prix Finaliste Príncipe Felipe à l'Excellence Industrielle, 2005
	<b>Premio Finalista Príncipe Felipe a la Excelencia Empresarial en Internacionalización, 2008</b> Príncipe Felipe Finalist Award to Corporate Excellence in Internationalization, 2008 Prix Finaliste Príncipe Felipe a l'Excellence Entreprise en Internationalisation, 2008		<b>Q de Plata EFQM, 2005</b> EFQM Silver Q Award, 2005 Q d'Argent EFQM, 2005
	<b>Premio Toribio Echevarría de Internacionalización, 2008</b> Toribio Echevarría Export Award, 2008 Prix Toribio Echevarría de l'Internationalisation, 2008		<b>Premio ARGILAN "Empresa y Empleo en Igualdad", 2005</b> ARGILAN Award for Gender Equality at the Work Place, 2005 Prix ARGILAN "Entreprise et Emploi en Egalité", 2005
	<b>Medalla de Oro al Diseño por la Oficina Nacional de la Normalización de Cuba, 2008</b> Gold Medal by the Cuban Office of Normalization, 2008 Médaille d'Or au Design par le Bureau National de la Normalisation de Cuba, 2008		<b>5 Medallas en el Salón Internacional de la Invención de París, "Concours Lepine", París 2004</b> 5 Medals received at the International Invention Competition in Paris, "Concours Lepine" 2004 5 Médailles au Salon International de l'Invention de Paris, "Concours Lepine", Paris 2004
	<b>Q de Plata EFQM, 2008</b> EFQM Silver Q Award, 2008 Q d'Argent EFQM, 2008		<b>Joven Empresario del Año, 2003</b> Young Businessman Award, 2003 Jeune Entrepreneur de l'Année, 2003
	<b>Premio Finalista Dato de Oro a la Empresa Solidaria de Álava, 2008</b> "Dato de Oro" Finalist Award on Corporate Social Responsibility, 2008 Finaliste Dato d'Or à l'Entreprise Solidaire d'Álava, 2008		<b>Premio Especial de la Unión Francesa de Inventores, 2003</b> Special Prize of French Inventor Association, 2003 Prix Spécial de l'Union Française des Inventeurs, 2003
	<b>La Llave Alavesa de EGA Master elegida para la Exposición "La Utilidad del Diseño" del Círculo de Bellas Artes, 2008</b> The Fine Arts Circle of Spain chooses the Basque Wrench for its "Usefulness of Design" Exhibition 2008 La Clé Basque d'EGA Master élue pour l'exposition « l'Utilité du Dessin » du Cercle des Beaux Arts, 2008		<b>Diploma de Ekoskan, 2003</b> Ekoskan Diploma 2003 Diplôme d'Ekoskan, 2003
	<b>Premio a la Integración Profesional de los Jóvenes de la Fundación Novia Salcedo, 2008</b> Excellence Award to the Professional Integration of Young People by Novia Salcedo Foundation, 2008 Prix à l'Intégration Professionnelle des Jeunes de la Fondation Novia Salcedo, 2008		<b>Medalla de Plata del Mundial de la Invención e Innovación, París 2003</b> Silver Medal at the World Congress of Innovation and Invention, Paris 2003 Médaille d'argent au Mondial de l'invention et de l'innovation, Paris 2003
	<b>Premio Mejor Producto del Año a la Mastergrip, 2007</b> Best Product Award for Mastergrip, 2007 Prix du Meilleur Produit de l'Année à la Mastergrip, 2007		<b>ISO 9001:2000, 2003</b> ISO 9001:2000, 2003 ISO 9001-2000, 2003
	<b>Premio al Mejor Diseño de la Oficina Nacional de Diseño Industrial de Cuba, 2007</b> Best Design Award National Office of Industrial Design of Cuba, 2007 Prix au Meilleur Design du Bureau National du Design Industriel de Cuba, 2007		<b>Premio a la Exportación, 2002</b> Export Award of Chamber of Commerce, 2002 Prix à l'Exportation, 2002
	<b>ISO 14001:2004, 2007</b> ISO 14001:2004, 2007 ISO 14001-2004, 2007		<b>Diploma de Excelencia EFQM, 2002</b> EFQM Excellence Diploma, 2002 Diplôme d'Excellence EFQM, 2002
	<b>5 Medallas obtenidas en el Salón Internacional de la Invención de París, "Concours Lepine", París 2007</b> 5 Medals received at the International Invention Competition in Paris, "Concours Lepine" April 2007 5 Médailles obtenues au Salon International de l'Invention de Paris, "Concours Lepine", Paris 2007		<b>Premio a la Innovación Metalmaq, 2001</b> Innovation Award at Metalmaq, Lisbon 2001 Prix à l'innovation Metalmaq, 2001
	<b>Premio a la Calidad, otorgado por el Ministerio de la Construcción de Cuba, 2007</b> Quality Award, Ministry of Construction of Cuba, 2007 Prix à la Qualité, attribué par le Ministère de la Construction de Cuba, 2007		<b>Trofeo Internacional a la Calidad, París 1998</b> International Quality Award, Paris 1998 Trophée International à la Qualité, Paris 1998
	<b>Empresa Alavesa del Año, 1998</b> Company of the Year, 1998 Entreprise de l'Année 1998 en Alava		



SEMINARIOS

SEMINARS

SÉMINAIRES

## BE SAFE...BE EFFICIENT

EGA Master ofrece a distribuidores y usuarios finales formación sobre las normativas de seguridad así como sobre la selección y uso apropiado de las herramientas de seguridad.

EGA Master offers training courses for distributors and end-users on safety regulations and the appropriate selection and use of safety tools.

EGA Master offre aux distributeurs et utilisateurs finaux une formation sur les normes de sécurité ainsi que sur le choix et l'utilisation approprié des outils de sécurité.

1 Seguridad y prevención  
Safety and prevention  
Sécurité et prévention



2 Directivas ATEX  
ATEX Directives  
Normes ATEX



3 Herramientas antichispa  
Non-sparking tools  
Outillage antidéflagrant



4 Herramientas aisladas 1000V  
1000V insulated tools  
Outillage isolé 1000V



5 Herramientas Anti-caída  
Antidrop tools  
Outillage antichute

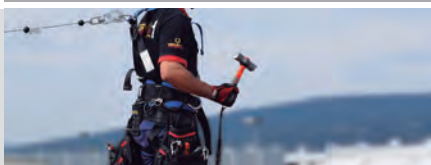

6 Ensayos y certificaciones  
Tests and certifications  
Tests et certificats



7 Apriete controlado  
Controlled tightening  
Serrage Controlé

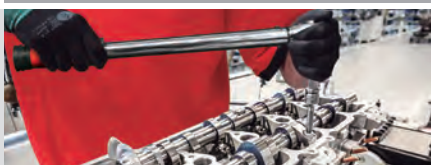



**Amy Yang**  
Procurement

**KBR - Kellogg Brown & Root LLC (USA)**

“ EGA Master was awarded a purchase order to supply Workshop Toolsets for the Sadara Project located in Saudi Arabia based on their commercially and technically acceptable offer.

KBR was very pleased with EGA Master’s responsiveness during the bidding phase and performance throughout the execution phase of the order. EGA Master exemplified excellent customer service, attention to detail and quality work which allowed the order to be inspected and delivered successfully and on-time.

KBR would definitely consider working with EGA Master again should the opportunity arise. ”

# TESTIMONIALS

## REPSOL

### Spain

Rafael Ramirez Gómez  
Static Reliability Chief- Reliability Department

"EGA Master has developed and custom-made special valve wrenches for Repsol."

## KELLOGG BROWN & ROOT

### USA

Amy Yang  
Procurement

"KBR was very pleased with EGA Master's responsiveness during the bidding phase and performance throughout the execution phase of the order. EGA Master exemplified excellent customer service, attention to detail and quality work which allowed the order to be inspected and delivered successfully and on-time."

## ENGIE

### Mexico

José Ángel Lázaro  
Head of Maintenance

"We have trusted EGA Master as our non-sparking tools supplier due to the high quality of its products. Furthermore, it is a reliable supplier that brings us the most complete service we have found in our industry. Safety is very important for us and through EGA Master we have access to the solutions we need to ensure the safety and productivity of our employees across the different business lines."

## PPG

### Mexico

Eng. Mario Feregrino  
EHS Team Leader

"At PPG safety is very important. Through EGA Master we have access to the solutions that we need to ensure the security and productivity of our employees."

## EGE HAINA

### Dominican Republic

Wendy Calderón  
Purchasing Manager

"We have trusted EGA Master for the supply of mechanical tools. In our industry, safety and quality are highly valued parameters and we feel really satisfied with the delivered products."

## EP PETROECUADOR

### Ecuador

Eng. Elías Valencia Delgado  
Terminals Head of Maintenance

"When you work at a Petrochemical company you are exposed to fire hazards that put at risk the life of your workforce, the most valuable assets a company has. We have therefore put our trust on EGA Master as a supplier of our Non-Spark CU-BE tools. This is due to the high quality of the tools and the wide range of products the company can offer us."

## AERNNNOVA

### Spain

Jose Manuel Guerra Verdejo  
Industrialization General Manager

"In record time, EGA Master implemented a complete line of smart workstations, designed and manufactured just for our needs. Technological know-how, ability to react quickly and adapt to changes, and especially the closeness and commitment to its clients are the main traits that best define EGA Master."

## TAP Engineering and Maintenance

### Portugal

Pedro Henriques  
Purchasing Manager

"EGA Master has been in this last 4 years a great support for TAP Engineering and Maintenance in Lisbon and Brazil. Key factors as top quality, delivery time, versatility, and constant innovation turned EGA Master into strategic partner with whom we can always trust in any situation."



## FOSELEV

### France

Cyril Rolland  
Resp. Matériel – Logistique

"Je recommanderais EGA Master à toute entreprise à la recherche d'un fournisseur proposant une large gamme de produit de haute qualité et d'un service rapide et efficace, peu d'entreprise de ce secteur sont à ce niveau de compétence."

## SUKHOI CIVIL AIRCRAFT

### Russia

Savchenko O.S.  
Deputy Director of the Technical Department

"Following the results of the tests carried out at the SCAC (Sukhoi Civil Aircraft Company) in Komsomolsk-en-Amur during 2017, it was decided to recommend the EGA Master branded products."

## MINISTÈRE DE L'ARMÉE DE L'AIR FRANÇAISE

### France

Stationnée à Djibouti

"La société EGA Master propose un large panel d'outillage de qualité dans différents domaines. Capable de concevoir de l'outillage adapté à un besoin particulier, EGAMASTER a répondu rapidement à nos demandes catalogue et hors catalogue. Toujours à l'écoute du retour client afin de répondre au mieux à vos attentes."

## CNOOC

### China

Ji Liu  
Maintenance Chief

"The Non-Sparking tools of EGA Master are perfect in fine detail and craftsmanship."

## BHARAT OMAN REFINERY

### India

Atul Khare  
Dy. Manager

"Safety is important for us, and through EGA Master, we are able to access the safety solutions that are needed to keep our workforce safe and productive."

## SAPURA-KENCANA

### Malaysia

Mr. Azmi Mohamed  
Senior Manager

"EGA Master's service is fast and responsive. We feel well supported to find solution to our needs."

## EXXONMOBIL

### Nigeria

Chidi Ahamefula  
Central Tools Coordinator

"Safety is the watch word in our company and using EGA Master tools has helped us maintain that record over the years. Using the right tool helps you accomplish your task timely and safely, and EGA Master tools have consistently fulfilled that need for us."

## ENDEL ENGIE

### Reunion Island

Bertrand Baret  
Purchasing Manager

"We are always looking to work with suppliers that can provide solutions that meet our needs. The ability of EGA Master to innovate and provide such a flexible service is of great value to us."

# MORE TESTIMONIALS

## RENAULT

### Portugal

Pedro Amorim  
Industrial Maintenance Technician

"In EGA Master, I have found tools that meet the safety requirements of maintenance professionals: Appropriate tools for our needs, short delivery times and technical support, are three important factors for a close partnership in the development of new solutions. That's what I found with EGA Master."

## COCA-COLA

### Cabo Verde

António Barros  
Technical Supervisor

"We are very satisfied with the personalization by laser marking and the quality of EGA Master tools, as well as with the company's after-sales service."

## VOLKSWAGEN

### Mexico

Edmundo Homero Cacho  
Engineer

"EGA Master's service is fast and effective. We believe that in EGA Master we have a supplier we can trust to find solutions to our needs."

## CELEC

### Ecuador

Fidel Chuchuca  
Head of Electrical Maintenance

"EGA Master 1000V insulated tools comply with the quality and safety standards that allow us perform our work with great confidence."

## FERREYROS CAT

### Peru

Victor Alfonso Quispe Trujillo  
Logistical support

"We recommend the use of EGA Master Copper-Beryllium sledge-hammers in mining operations because its alloy is safer in the activities of blade maintenance as it does not produce chips that may cause injuries to workers."

## PRAXAIR

### Peru

Enrique Rachitoff  
Bulk Distribution Manager

"We have chosen EGA Master as a supplier of non-sparking tools due to the high quality of their products and the wide range they offer us."

## ARCELORMITTAL

### Spain

Roberto Traver Barres  
Industrial Support Technician

"At EGA Master we have found a manufacturer with the industrial quality and safety orientation that Arcelor Mittal requires, with the necessary flexibility to adapt to our needs. The Total Safety Wrench in particular is a solution that meets our needs and that we have not found in the market."

## SOUTHERN PERU COPPER CORPORATION

### Peru

Mauricio Pérez  
Senior Concentrator Plant Maintenance

"The copper-beryllium sledge hammers from EGA Master have brought excellent results to our mining operations due to their safety and performance."

## IVECO DEFENCE

### Italy

Renato Modesto  
Machinery Responsible Engineer

"We always try to work with manufacturers that are able to provide solutions that meet our needs. EGA Master's ability to innovate and provide flexible services is of great value to us."

## TECHIMP IMPIANTI

### Italy

"In EGA Master we found a reliable partner that helped us find the best solutions to our problems. Thanks to EGA Master tools, our productivity has highly improved, keeping at the same time our high safety level."

## SONATRACH

### Algeria

Mohamed Khelif  
Mechanical Engineer

"EGA Master is a manufacturer that offers very good tools in terms of reliability, durability and finish."

## MERCEDES-BENZ

### Malaysia

Chantramohan Suparmaniam  
Production Manager

"EGA Master is a trusted supplier that offers us the best service in the industry. We see EGA Master as a key partner for us going forward."

## DARMA HENWA

### Indonesia

Rikko Denia  
Purchasing Manager

"We would recommend EGA Master to any company looking for the widest range of premium quality products, and a responsive service that nobody in the industry can match."

## ELETROPAULO

### Brasil

Glauber Lima Fraga  
Project Manager

"The persistence shown by EGA Master to find a solution that would meet the customer's needs is a clear evidence of EGA Master's commitment to fulfil the needs and requirements of its customers."

## SHELL

### Nigeria

Godfrey Ekeke  
Maintenance Planner

"EGA Master Tools are absolutely amazing tools in terms of value in safety, convenience and versatility."

# ÍNDICE INDEX SOMMAIRE

**1**

pag. 11-69

1000V - VDE



**2**

pag. 71-77

ESD



**3**

pag. 79-134

ANTI-DROP



**4**

pag. 135-139

ANTICHISPA AISLADA 1000V  
1000V INSULATED NON-SPARKING  
ANTI-DÉFLAGRANT ISOLÉ 1000V



**5**

pag. 141-273

ANTICHISPA  
NON-SPARKING  
ANTI-DÉFLAGRANT



**6**

pag. 275-330

ATEX SEGURIDAD INTRÍNSECA  
ATEX INTRINSIC SAFETY  
ATEX SÉCURITÉ INTRINSÈQUE

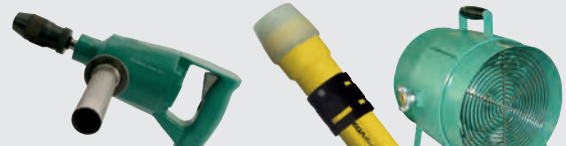

**7**

pag. 331-344

HIDRÁULICA  
HYDRAULIC  
HYDRAULIQUE

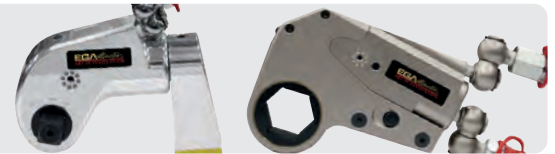

**8**

pag. 345-356

AQUAMASTER

USO SUBACUÁTICO  
UNDERWATER USE  
UTILISATION SUBAQUATIQUE



**9**

pag. 357-373

TITANIO AMAGNÉTICA  
TITANIUM NON-MAGNETIC  
TITANE ANTIMAGNÉTIQUE



**10**

pag. 375-411

HERRAMIENTA INOX  
INOX (STAINLESS STEEL) TOOLS  
OUTILLAGE INOX

INOX



**11**

pag. 413-426

EPI  
PPE

EQUIPOS DE PROTECCIÓN INDIVIDUAL  
PERSONAL PROTECTION EQUIPMENT  
EQUIPEMENTS DE PROTECTION INDIVIDUELLE



**1000V**

**1**

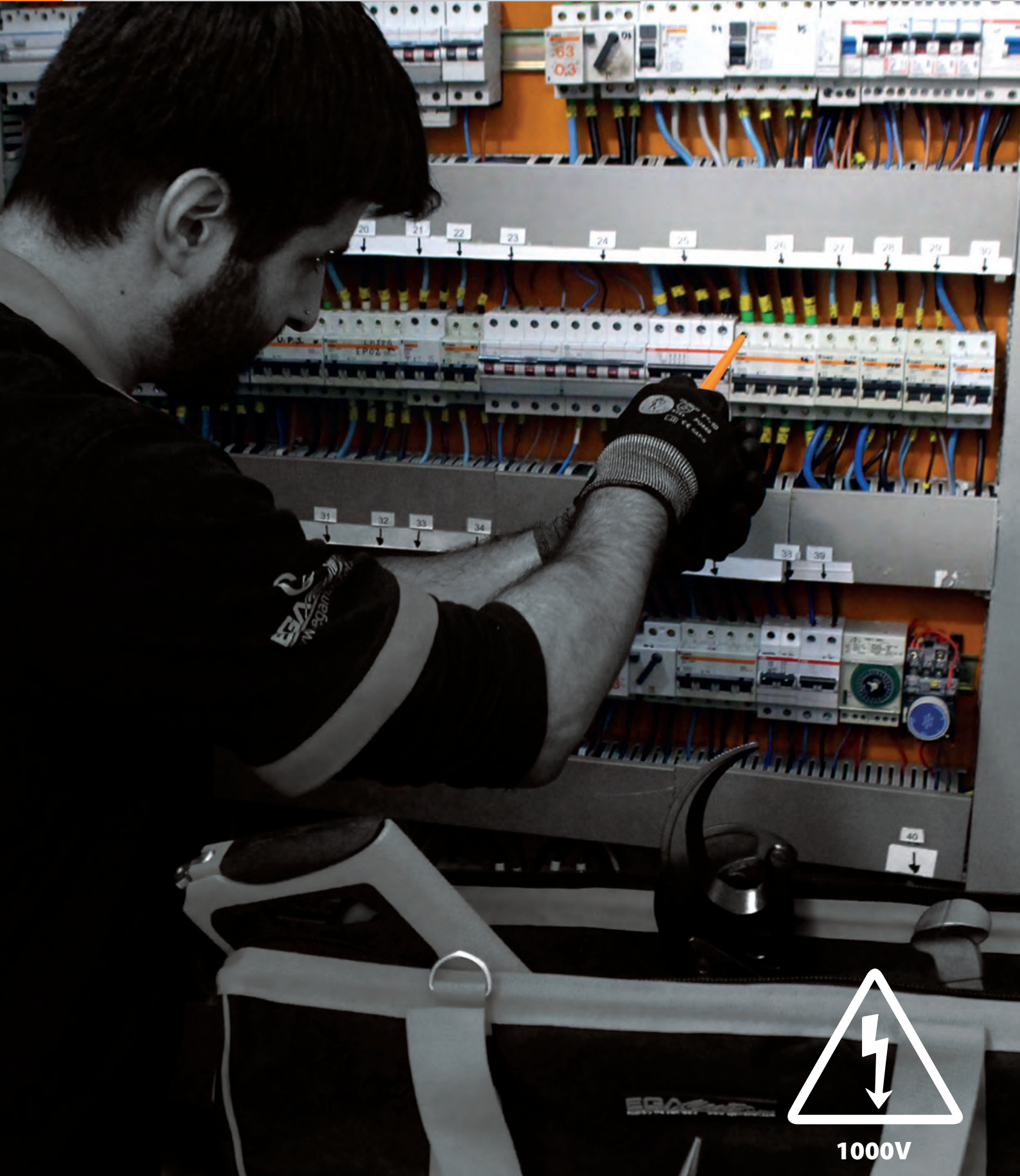

**1000V**

# 1000V IEC 60900

**EGA Master** ofrece una extensísima colección de herramientas de seguridad aisladas 1000V: alicates, destornilladores, llaves ajustables, cortacables de carraca, pinzas, cuchillos, tenazas, llaves fijas y de estrella, llaves de vaso (con sus correspondientes accesorios y juegos), arcos de sierra, etc.

*EGA Master offers a huge range of safety 1000V insulated handtools: pliers, screwdrivers, adjustable wrenches, tweezers, knives, sockets, spanners, hacksaws...*

**EGA Master** offre une vaste gamme d'outils isolés 1000V: pinces, tournevis, clés réglables, brucelles, couteaux, douilles, clés, scies à métaux...

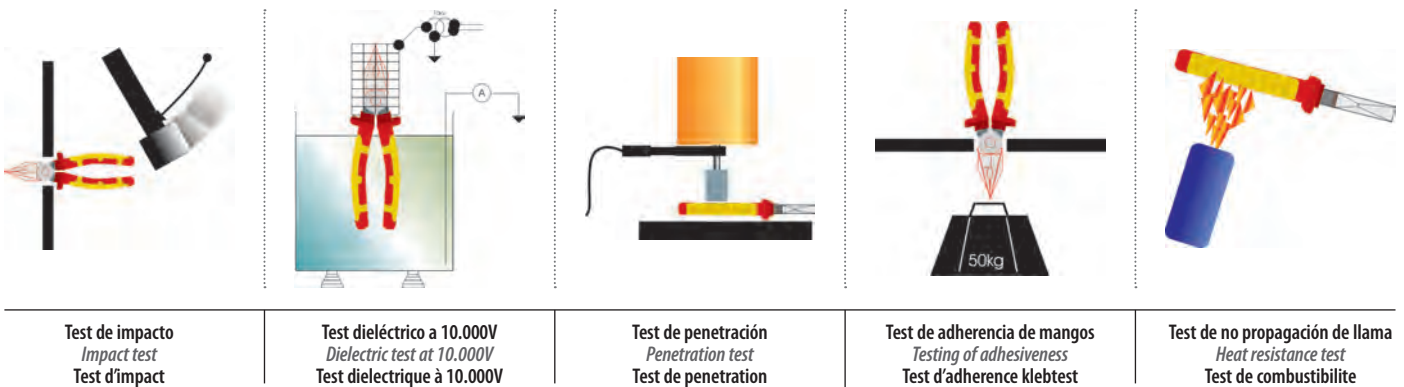

Test de impacto  
Impact test  
Test d'impact

Test dieléctrico a 10.000V  
Dielectric test at 10.000V  
Test dielectrique à 10.000V

Test de penetración  
Penetration test  
Test de penetration

Test de adherencia de mangos  
Testing of adhesiveness  
Test d'adhérence klebtest

Test de no propagación de llama  
Heat resistance test  
Test de combustibilité

Las herramientas aisladas de **EGA Master** cumplen con la normativa IEC 60900, siendo sometidas todas ellas al test dieléctrico a 10.000V (es decir, a una intensidad 10 veces mayor de la certificada). Las herramientas son objeto también de los tests de adherencia, penetración dieléctrica, impacto y propagación de llama de acuerdo a la rigurosa norma europea.

*EGA Master insulated tools comply with IEC 60900 international standard, each one of the pieces being tested at 10,000V (10 times the voltage we certify). They are also tested rigorously according to what the norms establishes: adherence test, impact test, flame propagation test and dielectric penetration test.*

Les outils isolés d'**EGA Master** sont conformes au norme IEC 60900. Chaque pièce est testée à 10.000V (nous certifions 10 fois la tension). Elles sont rigoureusement testées suivant les normes établies: essai d'adhérence, essai au choc, essai de propagation de flamme et essai de pénétration diélectrique.

## ■ PRINCIPALES CAMPOS DE APLICACIÓN MAIN APPLICATION FIELDS PRINCIPALES DOMAINES D'APPLICATION

Instaladores eléctricos <i>Electrical installation</i> Électriciens	Redes de baja tensión <i>Low Voltage networks</i> Réseaux de basse tension
Centrales eléctricas <i>Power plants</i> Centrales électriques	Telecomunicaciones <i>Telecommunications</i> Télécommunications
Estaciones y subestaciones eléctricas <i>Electric stations and substations</i> Stations et subdivisions électriques	Mantenimiento eléctrico <i>Electric maintenance</i> Maintenance électrique
Redes de alta tensión <i>High Voltage networks</i> Réseaux hautes tensions	Bomberos <i>Fire-fighters</i> Pompiers
Instalación y reparación de alumbrado <i>Lighting installation and repair</i> Voiries et réseaux divers (VRD)	

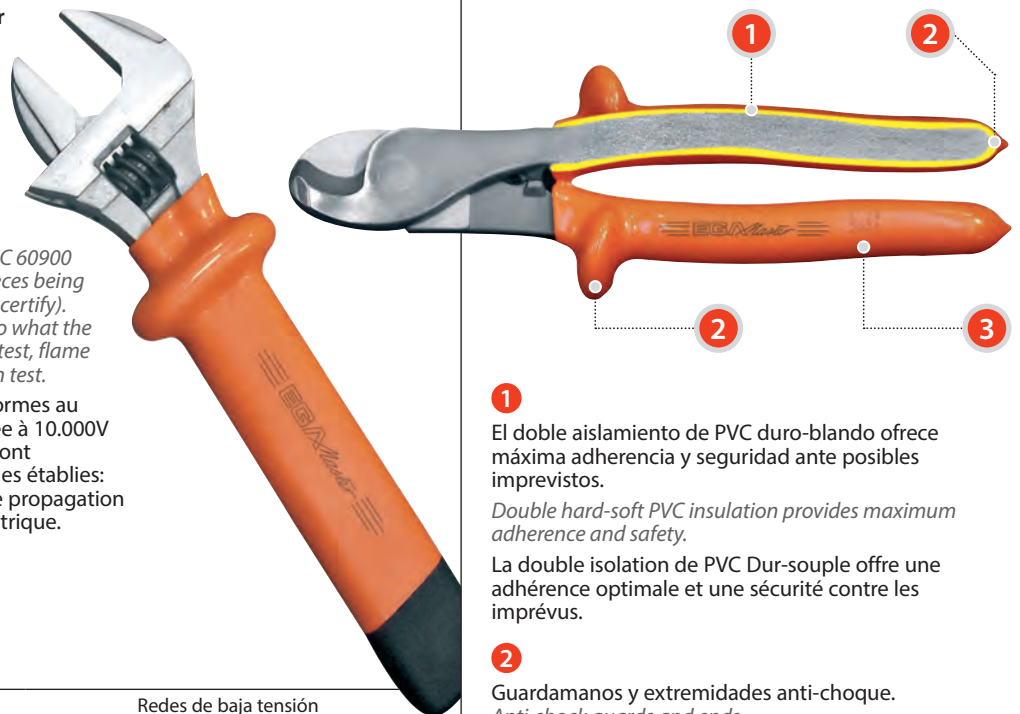

**1**  
El doble aislamiento de PVC duro-blando ofrece máxima adherencia y seguridad ante posibles imprevistos.

*Double hard-soft PVC insulation provides maximum adherence and safety.*

La double isolation de PVC Dur-souple offre une adhérence optimale et une sécurité contre les imprévus.

**2**  
Guardamanos y extremidades anti-choque.  
*Anti-shock guards and ends.*  
Poignées et extrémités anti-chocs.

**3**  
Marcado láser indeleble.  
*Un-erasable laser marking.*  
Marquage Laser indélébile.

**PRECAUCIONES  
CAUTION  
PRÉCAUTIONS**

- No emplear nunca la herramienta en aplicaciones bajo tensión si la protección presenta poros, fisuras, elementos incrustados o se ve la capa inferior de color amarillo.  
*Don't ever use tools under voltage if they present pores, fissures, encrusted elements or if the yellow insulation layer is visible.*  
Ne jamais utiliser l'outillage en tension si la protection semble poreuse, présente des fissures, que des corps étrangers sont incrustés ou que la couche inférieure est jaune.
- Se recomienda emplear suelos aislantes y calzado de seguridad en trabajos bajo tensión.  
*Insulating floors and safety shoes are recommended to work under voltage.*  
Pour des travaux sous tension, nous recommandons de travailler avec des tapis isolants et des chaussures de sécurité.
- Evite el contacto con agua mientras realice trabajos bajo tensión.  
*Avoid contact with water while working under voltage.*  
Éviter tout contact avec l'eau lors de réalisation des travaux de sous tension.
- No tocar directamente ninguna pieza susceptible de estar bajo tensión. Emplear un comprobador de tensión o tester.  
*Do not ever touch directly any item that may be under voltage. Use a voltage tester to check first.*  
Ne jamais toucher directement, une pièce susceptible d'être sous tension.

## CERTIFICADO DE HERRAMIENTAS AISLADAS VDE CERTIFICATE OF VDE INSULATED TOOLS CERTIFICAT D'OUTILS ISOLÉS VDE

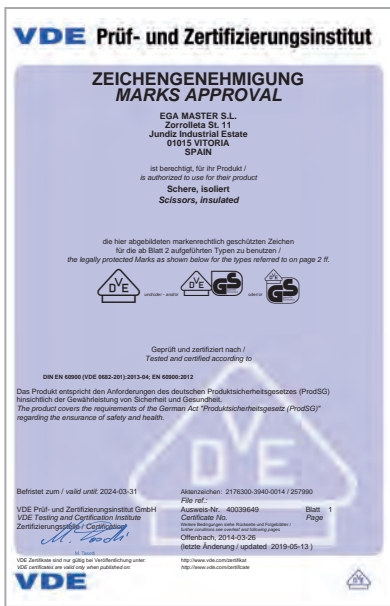





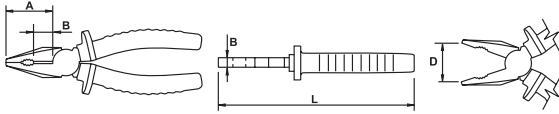

■ **ALICATES / PLIERS / PINCES / ZANGEN / PINZE / ALICATES / ПЛОСКОГУБЦЫ**

■ **TITACROM® BIMAT 1000V**

■ **UNIVERSALES / COMBINATION / UNIVERSELLES / KOMBIZANGEN / UNIVERSALE / UNIVERSAIS / КОМБИНИРОВАННЫЕ**



COD.	L (mm)	A (mm)	B (mm)	C (mm)	D (mm)						
<b>76582</b>	165	36	15	10	38	3	2	1,5	240		
<b>76583</b>	180	38	14	11	41	3,5	2,2		280	6	●
<b>76584</b>	200	43	17	12	50	4	2,5	2	330		

**TITACROM® BIMAT**   **1000V** | IEC 60900 | DIN 5746

Modelo registrado / Registered model / Modèle enregistré

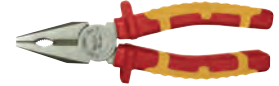

**CARACTERÍSTICAS / FEATURES / CARACTÉRISTIQUES**

Cr-V

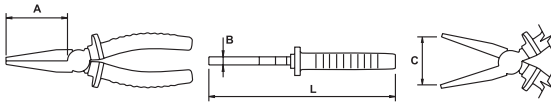

■ **BOCA PLANA / FLAT NOSE / BECS PLATS / FLACHZANGEN / BECCHI PIATTI / PONTAS CHATAS / УТКОНОСЫ**



COD.	L (mm)	A (mm)	B (mm)	C (mm)			
<b>76589</b>	160	55	8,5	40	170	6	●

**TITACROM® BIMAT**   **1000V** | IEC 60900 | DIN 5745

Modelo registrado / Registered model / Modèle enregistré



**CARACTERÍSTICAS / FEATURES / CARACTÉRISTIQUES**

Cr-V

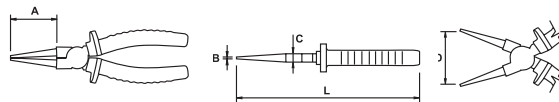

■ **BOCA REDONDA / ROUND NOSE / BECS RONDOS / RUNDZANGEN / BECCHI TONDI / PONTAS REDONDAS / КРУГЛОГУБЦЫ**



COD.	L (mm)	A (mm)	B (mm)	C (mm)	D (mm)			
<b>76590</b>	160	41	2	10	39	160	6	●

**TITACROM® BIMAT**   **1000V** | IEC 60900 | DIN 5745

Modelo registrado / Registered model / Modèle enregistré

**CARACTERÍSTICAS / FEATURES / CARACTÉRISTIQUES**

Cr-V



 Blando / Soft / Tendre  
20 Kg/mm<sup>2</sup>





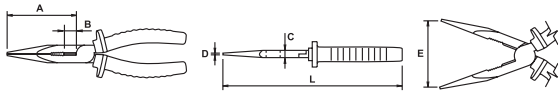

 Medio / Medium / Moyen  
75 Kg/mm<sup>2</sup>

 Duro / Hard / Dur  
180 Kg/mm<sup>2</sup>

 Cuerda piano / Piano wire / Corde de piano  
230 Kg/mm<sup>2</sup>



**TELEFONISTA / LONG NOSE / TÉLÉPHONE / TELEFONZANGEN / TELEFONISTI / TELEFONISTA / СУДЛИННЕННЫМИ НОСАМИ**

COD.	L (mm)	A (mm)	B (mm)	C (mm)	D (mm)	E (mm)						
<b>76591</b>	160	48	12	9,5	2,3	50	2,5	1,6	1	170	6	•
<b>76592</b>	200	70	14	10,5	2,6	80	3,2	2,2	1,5	210		





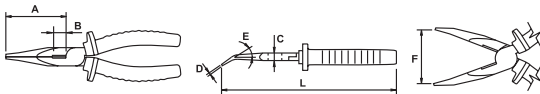

**TITACROM® Bimat**   1000V | IEC 60900 | DIN 5745

Modelo registrado / Registered model / Modèle enregistré

**CARACTERÍSTICAS / FEATURES / CARACTÉRISTIQUES**

Cr-V

**TELEFONISTA BOCA CURVA / BENT NOSE PLIERS / TÉLÉPHONE BECS COUDÉS / TELEFONZANGEN GEBOGEN / TELEFONISTI BECCHI PIEGATI / TELEFONISTA PONTAS CURVAS / ИЗОГНУТЫМИ НОСАМИ**

COD.	L (mm)	A (mm)	B (mm)	C (mm)	D (mm)	E (°)	F (mm)						
<b>76593</b>	160	41	12	9,0	2,7	32	47	2,5	1,6	1	160	6	•
<b>76594</b>	200	65	14	11	3,3		70	3,2	2,2	1,5	210		





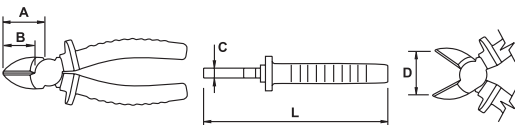

**TITACROM® Bimat**   1000V | IEC 60900 | DIN 5745

Modelo registrado / Registered model / Modèle enregistré

**CARACTERÍSTICAS / FEATURES / CARACTÉRISTIQUES**

Cr-V

**CORTE DIAGONAL / DIAGONAL CUTTING PLIERS / COUPANTES DIAGONALES / SEITENSCHNEIDER / TAGLIO LATERALE / CORTE DIAGONAL / УДЛИНЕННЫЕ ТОНКИЕ**

COD.	L (mm)	A (mm)	B (mm)	C (mm)	D (mm)						
<b>76595</b>	160	25	20	10	25	3	2,2	1,5	205	6	•
<b>76596</b>	190	32	26	11	29	3,2	2,5	2	250		



**TITACROM® Bimat**   1000V | DIN 5749 | IEC 60900





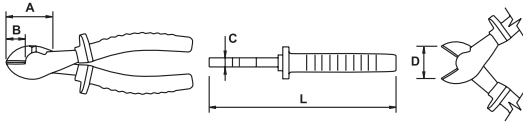

Modelo registrado / Registered model / Modèle enregistré

**CARACTERÍSTICAS / FEATURES / CARACTÉRISTIQUES**

Cr-V



**CORTE DIAGONAL REFORZADO / HEAVY DUTY CUTTING NIPPERS / COUPANTES RENFORCEÉS / VERSTÄRKTER SEITENSCHNEIDER / TAGLIO LATERALE RINFORZATO / CORTE DIAGONAL REFORÇADO / УСИЛЕННЫЕ БОКОРЕЗЫ**

COD.	L (mm)	A (mm)	B (mm)	C (mm)	D (mm)						
<b>76597</b>	180	43	21	11	25	3,2	2,5	2	350	6	•
<b>76598</b>	200	48			21	3,5	2,7	2,2	380		





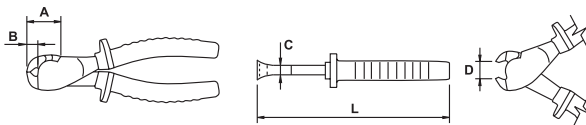

**TITACROM® Bimat**  **1000V** | IEC 60900 | DIN 5749

Modelo registrado / Registered model / Modèle enregistré

**CARACTERÍSTICAS / FEATURES / CARACTÉRISTIQUES**

Cr-V

**CORTE FRONTAL / END CUTTING NIPPER / COUPANTES DEVANT / VORSCHNEIDER / TAGLIO FRONTALE / CORTE FRONTAL / КЛЕЩИ**

COD.	L (mm)	A (mm)	B (mm)	C (mm)	D (mm)						
<b>76599</b>	160	27	9	11	9	3	2,5	2	250	6	•





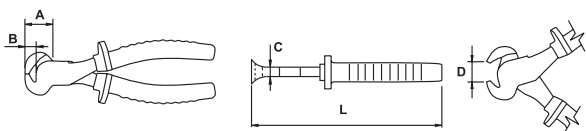

**TITACROM® Bimat**  **1000V** | IEC 60900 | DIN 5748

Modelo registrado / Registered model / Modèle enregistré

**CARACTERÍSTICAS / FEATURES / CARACTÉRISTIQUES**

Cr-V

**CORTE FRONTAL ELECTRICISTA / END CUTTING NIPPER (ELECTRICIAN) / COUPANTES DEVANT ELECTRICIEN / ELEKTRIKER VORSCHNEIDER / TAGLIO FRONTALE PER ELETTRICISTI / CORTE FRONTAL ELETTRICISTA / КЛЕЩИ (ЭЛЕКТРИЧЕСКИЕ)**

COD.	L (mm)	A (mm)	B (mm)	C (mm)	D (mm)						
<b>76600</b>	160	20	9	11	19	3	2,3	2	250	6	•
<b>76602</b>	200	22	11	14		3,5	2,8		410		

**TITACROM® Bimat**  **1000V** | IEC 60900 | DIN 5748

Modelo registrado / Registered model / Modèle enregistré

**CARACTERÍSTICAS / FEATURES / CARACTÉRISTIQUES**

Cr-V



### ■ PELACABLES / WIRESTRIPPER / PINCES À DÉNUDER / ABISOLIERZANGEN / PINZE SPELAFILI / DECAPADORES / КЛЕЩИ ДЛЯ ЗАЧИСТКИ КОНТАКТОВ

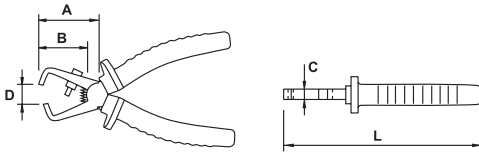

COD.	L (mm)	A (mm)	B (mm)	C (mm)	D (mm)	O.D. mm	g	mm	mm	mm
<b>76603</b>	160	44	37	9	21	0,5-6	170	6		●

**TITACROM® BIMAT** 1000V | IEC 60900 | DIN 5743

Modelo registrado / Registered model / Modèle enregistré



#### CARACTERÍSTICAS / FEATURES / CARACTÉRISTIQUES

Cr-V

### ■ KITS



COD.	PCS.	A	B
<b>76604</b>	3		
<b>76605</b>			

**TITACROM® BIMAT**

PCS./UN.	COD.	PCS.	mm
1	76607		180 mm
	76616		160 mm
	76603		

### ■ MASTERCUT TITACROM® BIMAT 1000V

### ■ UNIVERSALES / COMBINATION / UNIVERSELLES / KOMBIZANGEN / UNIVERSALE / UNIVERSAIS / КОМБИНИРОВАННЫЕ

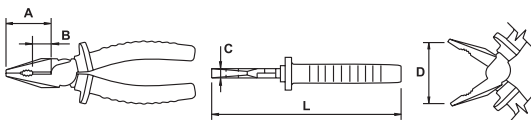

COD.	L (mm)	A (mm)	B (mm)	C (mm)	D (mm)	mm	mm	mm	g	mm	mm
<b>76606</b>	-	165	35	14	10	39	3,5		220		
<b>76607</b>		180	40	16		50	4	2,5	2	230	6
<b>76609</b>		210	44	19	11	60	4,5	2,8	2,2	280	



**TITACROM® BIMAT** 1000V | IEC 60900 | DIN 5746





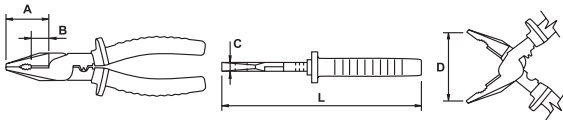

Modelo registrado / Registered model / Modèle enregistré

#### CARACTERÍSTICAS / FEATURES / CARACTÉRISTIQUES

Cr-V





COD.	L (mm)	A (mm)	B (mm)	C (mm)	D (mm)						
<b>76611</b>	235	43	19	13	55	5	3	2,5	380	6	●

**TITACROM® BIMAT**   1000V | IEC 60900 | DIN 5746

Modelo registrado / Registered model / Modèle enregistré





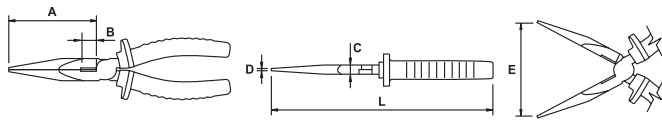

CARACTERÍSTICAS / FEATURES / CARACTÉRISTIQUES

Cr-V



TELEFONISTA / LONG NOSE / TÉLÉPHONE / TELEFONZANGEN / TELEFONISTI / TELEFONISTA / СУДЛИННЕННЫМИ НОСАМИ



COD.	L (mm)	A (mm)	B (mm)	C (mm)	D (mm)	E (mm)						
<b>76612</b>	160	55	11	9,5	2,5	46	3	2	1,5	170	6	●
<b>76613</b>	200	75	15	9,5	3	70	3,5	2,5	2	210	6	●

**TITACROM® BIMAT**   1000V | IEC 60900 | DIN 5745

Modelo registrado / Registered model / Modèle enregistré





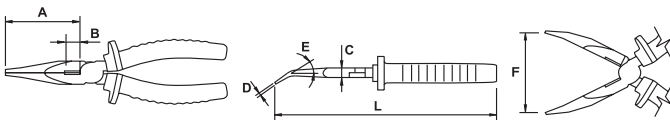

CARACTERÍSTICAS / FEATURES / CARACTÉRISTIQUES

Cr-V



TELEFONISTA BOCA CURVA / BENT NOSE PLIERS / TÉLÉPHONE BECS COUDÉS / TELEFONZANGEN GEBOGEN / TELEFONISTI BECCHI PIEGATI / TELEFONISTA PONTAS CURVAS / ИЗОГНУТЫМИ НОСАМИ



COD.	L (mm)	A (mm)	B (mm)	C (mm)	D (mm)	E (°)	F (mm)						
<b>76614</b>	160	50	13	9,5	3	32	41	3	2	1,5	170	6	●
<b>76615</b>	200	75	14	9,5	3	32	90	3,5	2,5	2	210	6	●

**TITACROM® BIMAT**   1000V | DIN 5745 | IEC 60900

Modelo registrado / Registered model / Modèle enregistré

CARACTERÍSTICAS / FEATURES / CARACTÉRISTIQUES

Cr-V







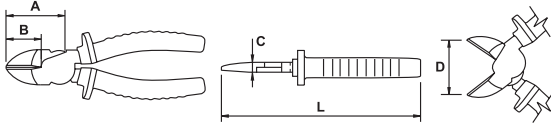

 Blando / Soft / Tendre  
20 Kg/mm<sup>2</sup>

 Medio / Medium / Moyen  
75 Kg/mm<sup>2</sup>

 Duro / Hard / Dur  
180 Kg/mm<sup>2</sup>

 Cuerda piano / Piano wire / Corde de piano  
230 Kg/mm<sup>2</sup>

**CORTE DIAGONAL / DIAGONAL CUTTING PLIERS / COUPANTES DIAGONALES / SEITENSCHNEIDER / TAGLIO LATERALE / CORTE DIAGONAL / УДЛИНЕННЫЕ ТОНКИЕ**

COD.	L (mm)	A (mm)	B (mm)	C (mm)	D (mm)						
<b>76616</b>	160	37	23	11	35	3	2,5	2	210	6	●
<b>76617</b>	190	40	25		29	3,5	2,7	2,2	250		

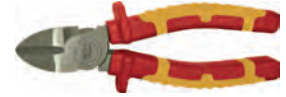



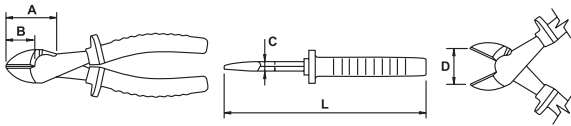

**TITACROM® Bimat**  **1000V** | DIN 5749 | IEC 60900

Modelo registrado / Registered model / Modèle enregistré

**CARACTERÍSTICAS / FEATURES / CARACTÉRISTIQUES**

Cr-V

**CORTE DIAGONAL REFORZADO / HEAVY DUTY CUTTING NIPPERS / COUPANTES RENFORCÉS / VERSTÄRKTER SEITENSCHNEIDER / TAGLIO LATERALE RINFORZATO / CORTE DIAGONAL REFORÇADO / УСИЛЕННЫЕ БОКОРЕЗЫ**

COD.	L (mm)	A (mm)	B (mm)	C (mm)	D (mm)						
<b>76618</b>	180	40	21	12	24	3,5	2,7	2,2	350	6	●
<b>76619</b>	200	40	21	12	22	4	3	2,5	380		



**TITACROM® Bimat**  **1000V** | DIN 5749 | IEC 60900

Modelo registrado / Registered model / Modèle enregistré

**CARACTERÍSTICAS / FEATURES / CARACTÉRISTIQUES**

Cr-V

**ALICATE DE PRESIÓN / PRESSURE PLIER / PINCE DE PRÉHENSION / KLEMMZANGE / PINZA A PRESSIONE / ALICATE TIPO UNIVERSAL ISOLADO / СЖИМАЮЩИЕ КЛЕЩИ**



COD.	L (mm)	
<b>73248</b>	150	90

 **1000V** | IEC 60900

**CARACTERÍSTICAS / FEATURES / CARACTÉRISTIQUES**



Para el montaje y bloqueo de contadores / For meter assembly and meter blocking / Conçue pour le montage et le verrouillage des compteurs

**ALICATES AISLANTES CON ZONA DE CORTE / INSULATING COMPOSITE CUTTING PLIERS / PINCES ISOLANTES AVEC ZONE DE COUPE / ARBEITSKOPFBFSCHICHTETE ZANGEN / PINZE ISOLATI CON ZONA DI TAGLIO / ALICATE DE CORTA ISOLADO EM COMPOSITE / ИЗОЛИРОВАННЫЕ КОМПОЗИТНЫЕ ПЛОСКОГУБЦЫ**
**UNIVERSALES / COMBINATION / UNIVERSELLES / KOMBIZANGEN / UNIVERSALE / UNIVERSAIS / КОМБИНИРОВАННЫЕ**

COD.	L (mm)		
<b>76544</b>	200	16	170

 **1000V** | IEC 60900

**BOCAS SEMI-REDONDAS / HALF ROUND NOSE / TÊTES DEMI-RONDES / LANGBECK-FLACHZANGE / ВЕСЧИ MEZZI TONDI / BOCAS SEMI-REDONDAS / ЗАКРУГЛЕННЫЕ ГУБКИ**

COD.	L (mm)		
<b>76549</b>	210	16	110

 **1000V** | IEC 60900

 Blando / Soft / Tendre  
20 Kg/mm<sup>2</sup>
 Medio / Medium / Moyen  
75 Kg/mm<sup>2</sup>
 Duro / Hard / Dur  
180 Kg/mm<sup>2</sup>
 Cuerda piano / Piano wire / Corde de piano  
230 Kg/mm<sup>2</sup>

**BOCA PLANA / FLAT NOSE / BECS PLATS / FLACHZANGEN / BECCHI PIATTI / PONTAS CHATAS / УТКОНОСЫ**

COD.	L (mm)	Max Cu-Ni	g
<b>76692</b>	190	16	110

⚡ 1000V | IEC 60900

**CORTACABLES / CABLE-CUTTER / COUPE CÂBLES / KABELSCHNEIDER / TAGLIACAVI / CORTA-CABOS / КАБЕЛЕРЕЗ**

COD.	L (mm)	Max Cu-Ni	g
<b>76539</b>	190	16	165

⚡ 1000V | IEC 60900

**GRAPA / INSULATING CLAMP / AGRAFE / KLEMMZANGE ISOLIERT / MORSETTO ISOLATO / GRAMPO ISOLADO / ИЗОЛИРОВАННЫЕ КЛЕЩИ**

COD.	L (mm)	Capacidad de agarre (mm) / Clamping capacity (mm) / Capacité d'adhérence (mm)	g
<b>73249</b>	150	15	76

⚡ 1000V | IEC 60900

**CARACTERÍSTICAS / FEATURES / CARACTÉRISTIQUES**

Para sujeción de las mantas aislantes / For holding insulating mats in place / Pour fixer des nappes isolantes

**ELECTRICIDAD / ELECTRICIAN TOOLS / OUTILLAGE D'ÉLECTRICIEN / ELEKTRIKERMESSEER / FERRAMENTI PER ELETTRICISTI / ELECTRICIDADE / ИНСТРУМЕНТ ДЛЯ ЭЛЕКТРИКА**
**ALICATE PARA UNIÓN DE CABLES AISLADOS Y NO AISLADOS / PLIER FOR CABLE LINKS INSULATED & NON INSULATED / PINCE POUR UNION DE CABLES ISOLES ET NON ISOLES / ZANGE FÜR ISOLIERTE UND NICHT ISOLIERT KABELSCHUHE / PINZE PER UNIRE CAVI ISOLATI E NON ISOLATI / ALICATE PARA UNIÃO DE CABOS ISOLADOS E NÃO ISOLADOS / КЛЕЩИ ДЛЯ ИЗОЛИРОВАННЫХ И НЕИЗОЛИРОВАННЫХ КОНТАКТОВ**

COD.	L (mm)	CAP. (mm <sup>2</sup> )	g		
<b>73257</b>	230	0,75-6	250	6	•

**TIJERAS / SCISSORS / CISEAUX / SCHERE / CESCOIE / TESOIRA / НОЖНИЦЫ**

COD.	L (mm)	g	
<b>79057</b>	160	98	•

⚡ 1000V | IEC 60900



COD.	L (mm)	g	
<b>79058</b>	160	98	•

⚡ 1000V | IEC 60900

**CARACTERÍSTICAS / FEATURES / CARACTÉRISTIQUES**

Muesca pequeña / Small breach / Petite brèche



COD.	L (mm)	g	
<b>79059</b>	160	98	•

⚡ 1000V | IEC 60900





**CARACTERÍSTICAS / FEATURES / CARACTÉRISTIQUES**

Muesca grande / Big breach / Grande brèche

**CORTACABLES DE CARRACA / RATCHET ELECTRICIAN CABLE CUTTER / COUPE-CABLES À CLIQUET / KABELSCHNEIDER MIT RATSCHER / TAGLIACAVI CRICCO PER ELETTRICI / CORTA CABOS DE ROQUETE PARA ELETRICISTA / КАБЕЛЕРЕЗЫ С ТРЕЩЕТОЧНЫМ МЕХАНИЗМОМ**

COD.	L (mm)	Cu (mm <sup>2</sup> )	Al (mm <sup>2</sup> )	 O.D. mm	 g	
<b>73010</b>	260	240	300	32	600	3
<b>73011</b>	380	400	600	52	800	6



COD.	L (mm)	Cu (mm <sup>2</sup> )	Al (mm <sup>2</sup> )	 O.D. mm	 g	
<b>73504</b>	450	800	1000	70	3700	1



**PELACABLES / CABLE STRIPPER / PINCES À DÉNUDER / ABISOLIERZANGE / SPELACAVI / DECAPADOR DE CABOS / СТРИПЕР**

COD.	L (mm)	 O.D. mm	Espesor / Thickness / Épaisseur	 g
<b>73088</b>	245	25-45	2	550



**PELACABLES PARA CABLES XLPE / WIRE STRIPPER FOR XLPE CABLES / PINCE À DÉNUDER POUR CÂBLES XLPE / ABISOLIERZANGE FÜR VPE-KABEL / SPELAFILI PER CAVI XLPE / ALICATE DESCARNADOR PARA XLPE / КЛЕЩИ ДЛЯ СНЯТИЯ ИЗОЛЯЦИИ С КАБЕЛЕЙ XLPE**

COD.	L (mm)	 g
<b>62121</b>	280	670



**PINZAS / TWEEZERS / BRUCELLES / GREIFPINZETTEN / PINZETTE DI PRECISIONE / PINÇAS / ПИНЦЕТЫ**

COD.	L (mm)	 g		
<b>73040</b>	130	15	12	•



**CARACTERÍSTICAS / FEATURES / CARACTÉRISTIQUES**

Boca fina / Neat Tips / Becs Fins

COD.	L (mm)	 g		
<b>73041</b>	150	15	12	•



**CARACTERÍSTICAS / FEATURES / CARACTÉRISTIQUES**

45°

**CUCHILLOS / KNIVES / COUTEAUX / MESSER / COLTELLI / FACIA / НОЖИ**

COD.	L (mm)	 mm	 g	
<b>73035</b>	170	50	110	12

**CARACTERÍSTICAS / FEATURES / CARACTÉRISTIQUES**



Recto / Straight / Droit

COD.	L (mm)	 mm	 g	
<b>73036</b>	180	30	100	12

**CARACTERÍSTICAS / FEATURES / CARACTÉRISTIQUES**

Curvo / Curved / Coudé



COD.	L (mm)			
<b>74990</b>	190	50	100	12

 1000V | IEC 60900



#### CARACTERÍSTICAS / FEATURES / CARACTÉRISTIQUES

Curvo / Curved / Coudé

Cuchilla curva con punta especial para pelar cables de forma segura / Curved blade with special bit for cable stripping / Avec une pointe spéciale afin de dénuder les câbles de façon sûre



#### BOQUILLAS ENCHUFABLES / PLASTIC SLIP-ON CLAPS / EMBOUTS DE SÉCURITÉ / KUNSTSTOFF-ÜBERZIEH-GRIFFE / UGELLI SLIP-STOP / PROTECTORES DE ENCAIXE PARA CABLE / ПЛАСТИКОВЫЕ РУКОЯТКИ

COD.	L (mm)	Conductor / Drive / Conducteur	 I.D. mm	
<b>73277</b>	100	1 #	10	10
<b>73278</b>		2 #		
<b>73279</b>		3 #		



 1000V | IEC 60900 | DIN VDE 0680/1

#### CARACTERÍSTICAS / FEATURES / CARACTÉRISTIQUES

Para protección contra puntas desnudas de cables en tensión / To cover bare live cable ends / Protège contre le contact avec des conducteurs dénudés sous tension



#### BOQUILLAS DE AUTOFIJACIÓN / SELF CLAMPING SLIP-ON CLAPS / EMBOUTS DE SÉCURITÉ AUTOBLOQUANTS / SELBTSKLEMMENDE KUNSTSTOFF-ÜBERZIEH-GRIFFE / UGELLI AUTOBLOCCANTI / PROTECTORES DE ENCAIXE AUTOMÁTICO PARA CABLE / ПЛАСТИКОВЫЕ РУКОЯТКИ САМОФИКСИРУЮЩИЕСЯ

COD.	L (mm)	 I.D. mm	
<b>73287</b>	80	10	7
<b>73288</b>	100	20	24
<b>73289</b>	110	30	38

 1000V | IEC 60900 | DIN VDE 0680/1



#### CARACTERÍSTICAS / FEATURES / CARACTÉRISTIQUES

Para protección contra puntas desnudas de cables en tensión / To cover bare live cable ends / Protège contre le contact avec des conducteurs dénudés sous tension



#### TENAZAS / PINCERS / PINCES / ZANGE / TENAGLIE / ALICATES / КЛЕЩИ

#### DE CANAL / BOX JOINT / MULTIPRISE ENTREPASSÉE / WASSERPUMPENZANGE / PINZE REGOLABILI / BICO DE PAPAGAIO / ШАРНИРНЫЕ

COD.	L (inch)			
<b>73004</b>	10	450	6	•
<b>73005</b>	12	600		

 1000V | IEC 60900



#### PICO DE LORO / GROOVE JOINT / MULTIPRISE À CRÉMAILLÈRE / WASSERPUMPENZANGE / PINZE REGOLABILI / BICO DE PAPAGAIO / С ЖЕЛОБКОВЫМ МЕХАНИЗМОМ

COD.	L (inch)			
<b>73001</b>	10	450	6	•

 1000V | IEC 60900



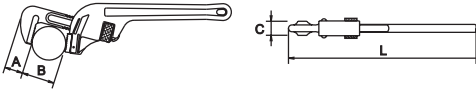

**LLAVE HEAVY DUTY CURVA / OFFSET HEAVY DUTY PIPE WRENCH / CLÉ SERRE-TUBES HEAVY DUTY COUDEE / GEKRÖPFTE ROHRZANGE / GIRATUBI MODELLO AMERICANO CURVO / CHAVE HEAVY DUTY INCLINADA / ИЗОГНУТЫЕ ТРУБНЫЕ КЛЮЧИ ДЛЯ БОЛЬШИХ НАГРУЗОК**

COD.	L (inch)	A (mm)	B (inch)	C (mm)	Kg		
76758	8	16	1	20	0,4		
76759	10	20	1.1/2	23	0,9	6	
76760	12	22	2	26	1,4		●
76761	14	25	2	29	1,6	5	
76762	18	27	2.1/2	33	2,4	3	-

⚠ 1000V | IEC 60900

**TENAZAS CORTACABLES / CABLE CUTTERS / COUPE-CÂBLES / KABELSCHNEIDER / CESCOIE PER CAVI / TESOURAS CORTA CABOS / КАБЕЛЕРЕЗЫ**

COD.	L (mm)	L (inch)	O.D. mm	Cu/Al (mm <sup>2</sup> )	g		
76147	150	6	9	35	180	6	●

⚠ 1000V | IEC 60900



COD.	L (mm)	L (inch)	O.D. mm	Cu/Al (mm <sup>2</sup> )	g		
73008	250	10	9	63	500	6	●

⚠ 1000V | IEC 60900

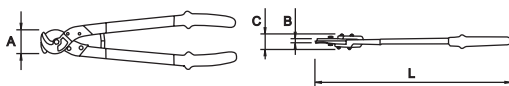

COD.	L (mm)	L (inch)	O.D. mm	A (mm)	Cu/Al (mm <sup>2</sup> )	B (mm)	C (mm)	g	
73009	600	24	14	70	154	16	55	1850	1

⚠ 1000V | IEC 60900

**CORTAVARILLAS / BOLT CUTTERS / COUPE-BOULONS / BOLZENSCHNEIDER / TAGLIABULLONI / CORTA VARÃO / АРМАТУРНЫЕ НОЖНИЦЫ**

COD.	L (inch)	CAP	Kg	
73020	18	50 kg/mm <sup>2</sup> 140 kg/mm <sup>2</sup>	1,7	1
73021	24	10-8	2,7	

⚠ 1000V | IEC 60900

**CORTATUBOS PARA TUBO DE PLÁSTICO / PLASTIC PIPE CUTTER / COUPE-TUBE PLASTIQUE / KUNSTSTOFFROHRSCHERE / CESCOIA PER TUBI DI PLASTICA / TESOURA PARA TUBO DE PLASTICO / ТРУБОРЕЗ ДЛЯ ПЛАСТИКА**
**PIRAINA®**

COD.	O.D. mm	g			V
76145	64	600	5	●	64752

⚠ 1000V | IEC 60900

**ESPECIFICACIONES TÉCNICAS / TECHNICAL SPECIFICATION / DÉTAILS TECHNIQUES**

Válido para / Valid for / Valable pour

KEVLAR, PVC, PE, PP, PB, VPE, PVDF, MLP, HTA, PPR, PEX, MULTILAYER

**CORTABRIDAS / PLASTIC TIE CUTTER / PINCE COUPE COLLIERS PLASTIQUES / KABELBINDER SCHNEIDER / PINZA TAGLIA FASCETTE IN NYLON / CORTA-ABRÇAIDEIRA / РЕЗАК ДЛЯ ПЛАСТИКОВЫХ ХОМУТОВ**

COD.	L (mm)			
<b>73042</b>	150	100	6	•

 1000V | IEC 60900 | RCD N° 2029504

**CARACTERÍSTICAS / FEATURES / CARACTÉRISTIQUES**

Corta bridas sin dañar los cables / It cuts the ties without damaging the cables / Il coupe les colliers plastiques sans abîmer les cables

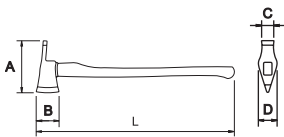



**CORTE / CUTTING / OUTILS COUPANTS / SCHNEIDWERKZEUG / ARCHETTI / CORTE / РЕЗКА**
**HACHA AZADA / HOE AXE / HACHE HOUE / WIEDEHOPFHACKE / ASCIA A ZAPPA / MACHADO ENXADA / ТОПОР МОТЫГА**

COD.	L (mm)	A (mm)	B (mm)	C (mm)	D (mm)		
<b>67243</b>	910	310	110	80	29	3,2	6





**CARACTERÍSTICAS / FEATURES / CARACTÉRISTIQUES**

Fibra de vidrio / Fiberglass / Fibre de verre



**ARCO DE SIERRA / HACK SAW / MONTURE DE SCIE À METAUX / METALLSÄGEN GEBOGEN / ARCHETTI / ARCO DE SERRA / НОЖОВКА**



COD.	 inch	 mm		
<b>73029</b>	6	150	500	1

 1000V | IEC 60900

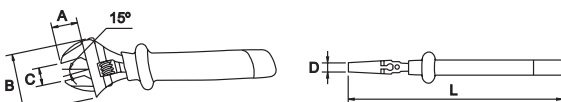
COD.	 inch	 mm		
<b>73030</b>	12	300	800	1

 1000V | IEC 60900



**LLAVES AJUSTABLES / ADJUSTABLE WRENCHES / CLÉS À MOLETTE / ROLLGABELSCHLÜSSEL / CHAVI REGOLABILI A RULLINO / CHAVES AJUSTAVELS / РАЗВОДНЫЕ КЛЮЧИ**
**TITACROM®**





COD.	L (inch)	L (mm)	A (mm)	B (mm)	C (mm)	D (mm)				
<b>76550</b>	*	6	150	20	47	19	6,5	200	4	•
<b>76551</b>	*	8	200	25	55	24	7	360		
<b>76552</b>	*	10	250	30	70	29	8,5	600		
<b>76553</b>	*	12	300	35	85	33,5	10	950		

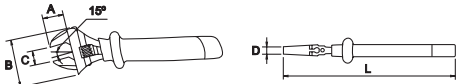

**TITACROM® 1000V** | Modelo registrado / Registered model / Modèle enregistré



\* Las ajustables aisladas a 1000V no se pueden homologar ya que la moleta no puede ser aislada, por lo tanto no se puede garantizar la seguridad del usuario, aunque el material aislante cumple la norma EN-60900 en cuanto a resistencia eléctrica. / The insulated adjustable wrenches 1000V can not be homologated as the wheel nut can not be insulated. The safety of the user can not be guaranteed, even though the insulated material fulfills the requirements of the norm EN-60900 regarding the electrical resistance. / Les clés à molette isolées 1000 V ne peuvent être homologuées, la molette ne pouvant être isolée, nous ne pouvons garantir la sécurité de l'utilisateur, malgré la conformité du matériau isolant à la norme EN-60900 sur la résistance électrique.

**FOSFATADA / PHOSPHATED / PHOSPHATÉE BRUNIE / PHOSPHATIERT / FINITURA BRUNITA / BRUNIDA / ЧЕРНЕННЫЙ**



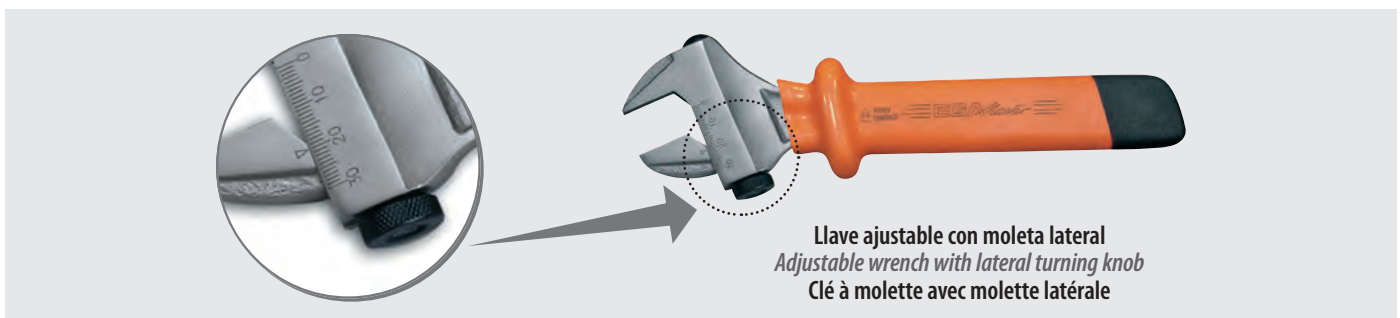
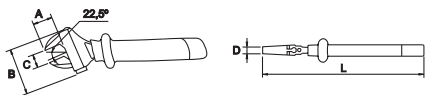

COD.		L (inch)	L (mm)	A (mm)	B (mm)	C (mm)	D (mm)			
76554	*	6	150	20	47	19	6,5	195		
76555	*	8	200	25	55	24	7	370	4	•
76556	*	10	250	30	70	29	8,5	650		
76557	*	12	300	35	85	33	10	1050		

**1000 V** | Modelo registrado / Registered model / Modèle enregistré

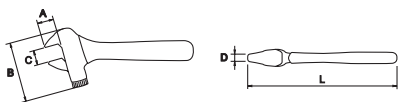
**MOLETA LATERAL / LATERAL NUT / MOLETTE LATÉRALE / MIT SCHNECKENROLLE / RULLINO LATERALE / MOLETA LATERAL / РИГУЛИРОВОЧНАЯ ШАЙБА**

**TITACROM®**

COD.		L (inch)	L (mm)	A (mm)	B (mm)	C (mm)	D (mm)			
76578	*	6	150	20	55	19	8,5	200		
76579	*	8	200	24	65	24	9,5	400	4	•
76580	*	10	250	30	80	29	11	600		
76581	*	12	300	36	95	33	12	1000		

**TITACROM® 1000V**
**1000V**

COD.		L (inch)	L (mm)	A (mm)	B (mm)	C (mm)	D (mm)			
79470		8	200	25	95	29	11	370		
79471		10	250	32	105	33	14	620	1	•
79472		12	300	40	120	38	14	1000		

**1000V** | IEC 60900

\*Las ajustables aisladas a 1000V no se pueden homologar ya que la moleta no puede ser aislada, por lo tanto no se puede garantizar la seguridad del usuario, aunque el material aislante cumple la norma EN-60900 en cuanto a resistencia eléctrica. / The insulated adjustable wrenches 1000V can not be homologated as the wheel nut can not be insulated. The safety of the user can not be guaranteed, even though the insulated material fulfils the requirements of the norm EN-60900 regarding the electrical resistance. / Les clés à molette isolées 1000 V ne peuvent être homologuées, la molette ne pouvant être isolée, nous ne pouvons garantir la sécurité de l'utilisateur, malgré la conformité du matériau isolant à la norme EN-60900 sur la résistance électrique.

### ■ LLAVES / WRENCHES / CLÉS / SCHLÜSSEL / CHIAVI / CHAVES / КЛЮЧИ

### ■ FIJA DE UNA BOCA / SINGLE ENDED OPEN JAW SPANNER / À FOURCHE / EINMAULSCHLÜSSEL / FISSE SEMPLICE / FIXA DE UMA BOCA / ОДНОРОЖКОВЫЙ КЛЮЧ

#### ■ MM



COD.	AF mm	L (mm)	g		
73086	5,5				
73060	6	90	15		
73061	-	7	100		
73062	-	8	105		
73063	-	9	120		
73064		10	125	30	
73065	-	11	133	35	
73066	-	12			
73067	-	13	142	45	10
73068		14		55	
73069	-	15			
73070	-	16	164	60	
73071		17	165	70	
73072	-	18		80	
73073		19	176	95	
73074	-	20		100	
73075	-	21	201	185	
73076		22		150	
73078	-	23		160	
73077		24	226	185	
73079		27		230	
73080	-	28	246	270	5
73081	-	29		300	
73082	-	30		350	
73083		32	281	370	

1000V | IEC 60900

#### ■ INCH



COD.	AF inch	L (mm)	g		
73043	1/4	90			
73044	9/32	110	30		
73045	5/16				
73046	3/8	127	40		
73047	7/16	135	45		10
73048	1/2	147	55		
73049	9/16		75		
73050	5/8	166	100		
73051	11/16		120		
73052	3/4	176	130		
73053	13/16		180		
73054	7/8	200	190		
73055	15/16	226	220		5
79483	1	250	350		
79484	1.1/8	266		450	
79485	1.1/4	281			

1000V | IEC 60900

### ■ KIT DEMO 6 LLAVES / 6 SPANNER DEMO KIT / KIT DÉMO. 6 CLÉS / DEMOKIT 6 SCHLÜSSEL / KIT 6 CHIAVI DI DIMOSTRAZIONE / KIT DEMO 6 CHAVES / ДЕМО НАБОР ИЗ 6 КЛЮЧЕЙ

COD.	g
69342	300

COD. PCS.	mm
61727	Aerospacial / Aerospacial
38092	INOX
73062	1000V
70172	Cu-Be
70684	Al-Bron
71669	Titanio / Titanium



8

**LLAVE DE ESTRELLA ACODADA UNA BOCA / OFFSET RING WRENCH / CLÉ POLYGONALE CONTRE-COUDÉE / GEKRÖPFTE RINGSCHLÜSSEL / CHIAVE POLIGONALE AD UNA BOCCA / CHAVE DE LUNETAS INCLINADA / КЛЮЧ ИЗОГНУТАЯ ЗВЕЗДОЧКА**

■ MM



COD.	AF mm	L (mm)	g		
73090	6	140	50		
73091	7	145	50		
73092	8	150	55		
73093	9	155	75		
73094	10	160	80		
73095	11	170	90		
73096	12	180	100		
73097	13	180	105		
73098	14	190	130		
73099	15	200	140	10	
73100	16	200	150		
73101	17	210	160		
73102	18	210	210		
73103	19	220	230		
73105	21	240	280		
73106	22	250	300		
73107	23	260	320		
73108	24	260	350		
73109	26	300	550		
73110	27	310	600		
73111	28	310	600		
73112	29	310	600		
73113	30	310	600		
73114	32	330	650	5	
73115	36	350	1100		
73116	38	350	1100		
73117	41	380	1150		
73118	42	400	1200		
73119	46	440	1200		
73104	50	460	1300		

 1000V | IEC 60900

■ INCH



COD.	AF inch	L (mm)	g		
73347	1/4	140	50		
73348	5/16	150	75		
73349	3/8	160	85		
73350	7/16	170	95		
73351	1/2	180	125		
73352	9/16	190	165	10	
73353	5/8	200	190		
73354	11/16	220	210		
73355	3/4	220	250		
73356	13/16	240	320		
73357	7/8	250	340		
73358	15/16	260	390		
73359	1	270	450		
73360	1.1/16	280	500	5	
73361	1.1/8	290	550		
73363	1.1/4	305	600		

 1000V | IEC 60900

### LLAVE DE ESTRELLA DE CARRACA PLANA / RING RATCHET / POLYGONALE À CLIQUET / KNARRE RINGSCHÜSSEL / CHIAVE POLIGONALE PIATTA CON CRICCO / CHAVE DE LUNETAS COM ROQUETE PLANA / ЗВЕЗДОЧКА С ТРЕЩЕТКОЙ

MM

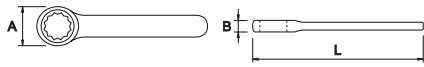

COD.	AF mm	L (mm)	A (mm)	B (mm)	g		
73145	10	136	25	13	60		
79423	11	140	26	14	65		
79424	12	147	29	15	75		
73147	13	152	31	15	95		
79425	14	160	32	16	120		
79426	15	165	34	16	135	6	•
79427	16	170	36	17	150		
73150	17	190	38	18	175		
79428	18	190	38	18	175		
73152	19	210	39	18	190		

1000V | IEC 60900

INCH



COD.	AF inch	L (mm)	A (mm)	B (mm)	g		
79429	9/16	165	32	16	103		
79430	3/4	205	39	18	209	6	•
79431	7/8	235	47	20	289		

1000V | IEC 60900

### LLAVE DE ESTRELLA INCLINADA UNA BOCA / ANGLE RING WRENCH / CLÉ POLYGONALE DROITE / GEBOGEN RINGSCHLÜSSEL / CHIAVE A STELLA INCLINATA / CHAVE LUA / КЛЮЧ ЗВЕЗДОЧКА ИЗОГНУТАЯ

MM



COD.	AF mm	L (mm)	g		
73120	8	90	25		
73121	9	100	30		
73122	10	110	40		
73123	11	115	50		
73124	12	125	60		
73125	13	135	80		
73126	14	140	95		
73127	15	145	110		
73128	16	150	125	10	•
73129	17	160	135		
73130	18	170	145		
73131	19	175	175		
73133	21	185	210		
73134	22	195	240		
73135	23	210	250		
73136	24	230	275		

1000V | IEC 60900

INCH



COD.	AF inch	L (mm)	g		
73160	5/16	90	25		
73189	3/8	110	40		
73190	7/16	115	50		
73191	1/2	135	80		
73192	9/16	140	95	10	
73198	5/8	150	125		
73199	11/16	170	145		
73200	3/4	175	175		
73201	7/8	195	240		
73202	15/16	230	275		
79486	1	245	290		
79487	1.1/8	300	460	5	
79488	1.1/4	320	600		

1000V | IEC 60900

**LLAVES DE PIPA ABIERTAS / ANGLED OPEN SOCKETS / CLÉS À PIPE / PFEIFFENKOPFSCHLÜSSEL / CHIAVI A PIPA APERTE / CHAVE DE CACHIMBO ABERTAS / ГОЛОВКА С РУКОЯТКОЙ ПОД 90 ГРАДУСОВ**

MM

COD.	AP mm	L (mm)	g		
73203	8		45		
73204	9	110	60		
73205	10	125	85		
73206	11	135	100		
73207	12	145	130		
73208	13	155	160		
73209	14	165	185		
73210	15	170	220	5	
73211	16	175	230		
73212	17	180	280		
73213	18	190	330		
73214	19	195	430		
73215	20	210	460		
73216	21	220	500		
73217	22	240	650		
73218	23	260	700		
73219	24	270	750		
73220	25		800		
73221	26	290	1000		
73222	27	300	1100	1	
73223	28	320	1150		
73224	29	330	1300		
73225	30				
73226	32	350	1150		

 1000V I IEC 60900

**LLAVE DE TUBO MANGO EN T / T HANDLE WRENCH / CLÉ EN T / T-GRIFF SCHLÜSSEL / CHIAVE A TUBO CON IMPUGNATURA A T / CHAVES T TUBOLARES / ГОЛОВКА С РУКОЯТКОЙ Т**

MM

COD.	AP mm	L (mm)	g		
73170	6	125	70		
73171	7		85		
73172	8		95		
73173	9		120		
73174	10		140		
73175	11	135	175		
73176	12		185		
73177	13		220		
73178	14		260		
73179	15		275	10	
73180	16		290		
73181	17		300		
73182	18		330		
73183	19	150	360		
73184	20		370		
73185	21		420		
73186	22	135	430		
73187	23		440		
73188	24	150	450		

 1000V I IEC 60900

■ EN CRUZ / CROSS RIM WRENCH / CLÉ EN CROIX / KREUZSCHLÜSSEL / CHIAVE A CROCE / CHAVE DE CRUZETA / КРЕСТООБРАЗНЫЙ КЛЮЧ

COD.	AF mm	g		
73165	6-8-10-12	280		
73167	8-10-12-14	330	6	•

⚠ 1000V | IEC 60900



■ LLAVES HEXAGONALES / HEXAGONAL KEYS / CLÉS MÂLES / WINKELSCHRAUBENDREHER / CHIAVI ESAGONALI / CHAVES HEXAGONAIS / ШЕСТИГРАННЫЕ КЛЮЧИ

■ MM



COD.	AF mm	g		
73155	3	16		
73156	4	30		
73157	5	42	10	•
73158	6	55		
73159	8	100		

⚠ 1000V | IEC 60900

■ INCH



COD.	AF inch	g		
73025	1/8	20		
73026	3/16	30		
73027	7/32	50	10	•
73028	15/64	55		
73037	5/16	100		

⚠ 1000V | IEC 60900

■ SERIE LARGA / LONG SOCKET / SÉRIE LONGUE / LANGE SERIE / SERIE LUNGA / SERIE LONGA / ВЫСОКАЯ СЕРИЯ

■ MM



COD.	AF mm	L (mm)	g		
79388	1,5	65	3		
79389	2	80	5		
79394	2,5	90	6		
79370	3	100	15		
79371	4	110	25		
79372	5	125	35	10	•
79373	6	145	50		
79374	8	165	90		
79375	10	185	160		
79376	12	205	300		

⚠ 1000V | IEC 60900

■ INCH







COD.	AF inch	L (mm)	g		
79377	1/8	100	15		
79378	9/64	105	18		
79379	5/32	110	20		
79380	3/16	110	30		
79381	7/32	130	40		
79382	1/4	140	60	10	•
79383	5/16	155	90		
79384	3/8	175	150		
79385	7/16	195	250		
79386	1/2	215	250		
79387	5/8	255	400		

⚠ 1000V | IEC 60900





**LLAVES HEXAGONALES EN T / T HEXAGONAL KEYS / CLÉS MÂLES EN T / T-INBUSSCHLÜSSEL / CHIAVI ESAGONALI A T / CHAVES HEXAGONAIS EM T / Т-ОБРАЗНЫЕ КЛЮЧИ ДЛЯ ШЕСТИГРАННИКОВ**

MM

COD.		L (mm)			
79390	5	120 x 90	185	10	●
79391	6				
79392	8		245		
79393	10		325		

 1000V | IEC 60900

**APRIETE CONTROLADO / CONTROLLED TIGHTENING / SERRAGE CONTROLÉ / KONTROLLIERTES ANZIEHEN / CONTROLLO DI SERRAGGIO / APERTO CONTROLADO / КОНТРОЛИРУЕМАЯ ЗАТЯЖКА**
**LLAVE DINAMOMÉTRICA / TORQUE WRENCH / CLÉ DYNAMOMÉTRIQUE / DREHMOMENT-SCHRAUBENSCHLÜSSEL / CHIAVE DINAMOMETRICA / CHAVE DINAMOMÉTRICA / ДИНАМОМЕТРИЧЕСКИЕ КЛЮЧИ**

COD.		N.m	Lb.in	L (mm)		
79433	3/8	5-25	44,2-211	370	1,1	1

 1000V | IEC 60900

**ESPECIFICACIONES TÉCNICAS / TECHNICAL SPECIFICATION / DÉTAILS TECHNIQUES**

Precisión / Accuracy / Précision 4%

COD.		N.m	L (mm)		
75034	3/8	10-50	300	850	1
75024		20-100	400	1000	

 1000V | IEC 60900

**ESPECIFICACIONES TÉCNICAS / TECHNICAL SPECIFICATION / DÉTAILS TECHNIQUES**

Precisión / Accuracy / Précision 4%



COD.		N.m	Lb.ft	L (mm)		
79435	1/2	20-200	15-150	500	1,4	1

 1000V | IEC 60900

**ESPECIFICACIONES TÉCNICAS / TECHNICAL SPECIFICATION / DÉTAILS TECHNIQUES**

Precisión / Accuracy / Précision 4%

**DESTORNILLADOR DINAMOMETRICO / TORQUE SCREWDRIVER / TOURNEVIS DYNAMOMÉTRIQUE / DREHMOMENT SCHRAUBENDREHER / CACCIAVITE DINAMOMETRICO / CHAVE DE FENDAS DINAMOMÉTRICA / ОТВЕРТКА С УСТАНОВКОЙ МОМЕНТА ЗАТЯГИВАНИЯ**

COD.		N.m	Lb.in	L (mm)		
79891	1/4	-	10-50	210	445	1
79889		1-6				
79890		0.5-4.5				

 1000V | IEC 60900

**ESPECIFICACIONES TÉCNICAS / TECHNICAL SPECIFICATION / DÉTAILS TECHNIQUES**

Certificado de calibración / Calibration certificate / Certificat de calibrage ●

Precisión / Accuracy / Précision +/-6%

### ■ LLAVES DE VASO / SOCKET WRENCHES / DOUILLES / STECKSCHLÜSSEL / BUSSOLE DOPPEN / CHAVES DE CAIXA / ГОЛОВКИ

■ 1/4"

■ STANDARD

■ MM

■ 6 PT.

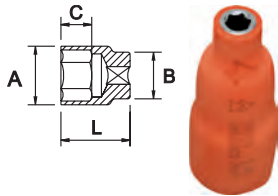

COD.	AF mm	L (mm)	A (mm)	B (mm)	C (mm)	Pt	g	
73230	4		11					
73228	4,5		12					
73231	5		13			15		
73229	5,5		14					
73232	6		16		11			
73233	7		17					
73234	8	42	18	18		6		10
73235	9		19					
73236	10		21				25	
73237	11		22					
73238	12		23		15		30	
73239	13							
73240	14						35	

⊕ 1000V | IEC 60900

■ INCH

■ 6 PT.

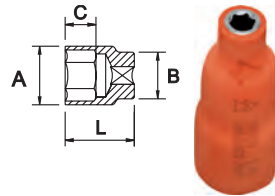

COD.	AF inch	L (mm)	A (mm)	B (mm)	C (mm)	Pt	g	
73366	5/32		11					
73367	3/16		12				15	
73368	7/32		13					
73369	1/4		14			11	17	
73370	9/32		16				19	
73371	5/16	42	17	18		6	23	10
73372	11/32		18				27	
73373	3/8		20				29	
73374	7/16		21				30	
73377	15/32		22		15			
73375	1/2		23				35	
73376	9/16							

⊕ 1000V | IEC 60900

■ 12 PT.

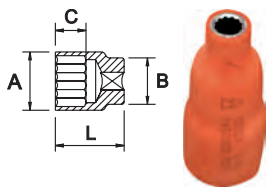

COD.	AF mm	L (mm)	A (mm)	B (mm)	C (mm)	Pt	g	
73241	4		11					
73242	4,5		12					
74885	5		13			15		
74886	5,5		14					
74887	6		16		11			
74888	7		17					
74889	8	42	18	18		12		10
74890	9		19					
74891	10		21				25	
74892	11		22					
74893	12		23		15		30	
74894	13							
74895	14						35	

⊕ 1000V | IEC 60900

■ 12 PT.

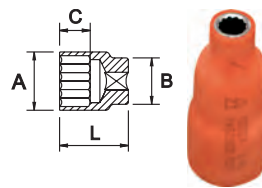

COD.	AF inch	L (mm)	A (mm)	B (mm)	C (mm)	Pt	g	
73365	5/32		11					
74900	3/16		12				15	
74901	7/32		13					
74902	1/4		14			11	17	
74903	9/32		16				19	
74904	5/16	42	17	18		12	23	10
74905	11/32		18				27	
74906	3/8		20				29	
74907	7/16		21				30	
74910	15/32		22		15			
74908	1/2		23				35	
74909	9/16							

⊕ 1000V | IEC 60900

1/4"

■ **SERIE LARGA / LONG SOCKET / SÉRIE LONGUE / LANGE SERIE / SERIE LUNGA / SERIE LONGA / ВЫСОКАЯ СЕРИЯ**

■ **MM**

■ **6 PT.**

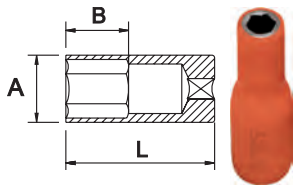

COD.	AF mm	L (mm)	A (mm)	B (mm)	Pt	g	Icon
75050	4		7,5				
75051	4,5		8,0				
75052	5		9,0	8,0			
75053	5,5		10			33	
75054	6		11				
75055	7		12	10			
75056	8	48	14		6	35	10
75057	9		15			42	
75058	10		17			50	
75059	11		18	12		55	
75060	12		20			65	

⊕ 1000V | IEC 60900

■ **INCH**

■ **6 PT.**

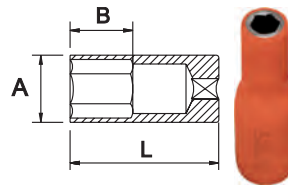

COD.	AF inch	L (mm)	A (mm)	B (mm)	Pt	g	Icon
75085	3/16		9,0				
75086	7/32		10	8,0		33	
75087	1/4		11				
75088	9/32		13	10		35	
75089	5/16		14		6	42	10
75090	11/32	48	17			47	
75091	3/8		19	12		50	
75092	7/16		21			55	
75093	1/2					65	
75094	9/16						

⊕ 1000V | IEC 60900

■ **12 PT.**

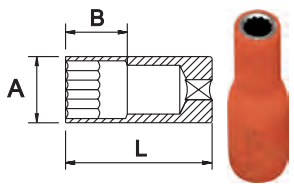

COD.	AF mm	L (mm)	A (mm)	B (mm)	Pt	g	Icon
75070	5		9,0				
75071	5,5		10	8,0			
75072	6		11			33	
75073	7		12	10			
75074	8		14			35	
75075	9	48	15		12	42	10
75076	10		17			46	
75077	11		18	12		50	
75078	12		20			55	
75079	13					65	
75080	14						

⊕ 1000V | IEC 60900

■ **12 PT.**

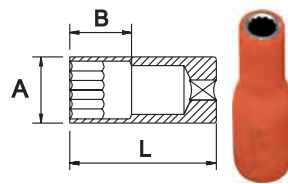

COD.	AF inch	L (mm)	A (mm)	B (mm)	Pt	g	Icon
75100	5/32		7,0				
75101	3/16		9,0	8,0		33	
75102	7/32		10				
75103	1/4		11				
75104	9/32		13	10		35	
75105	5/16	48	14		12	42	10
75106	11/32		17			46	
75107	3/8		19	12		50	
75108	7/16		21			55	
75109	1/2					65	
75110	9/16						

⊕ 1000V | IEC 60900

1/4"

**LLAVE DE CARRACA REVERSIBLE / REVERSIBLE RATCHET HANDLE / CLÉ À CLIQUET RÉVERSIBLE / UMSCHALTKNARRE / CHIAVE A CRICCO REVERSIBILE / ROQUETE REVERSIVEL / РЕВЕРСИВНАЯ ТРЕЩЕТКА**

COD.	AF inch	L (mm)	g		
<b>73687</b>	1/4	124	140	6	•

⚠ 1000V | IEC 60900

**ALARGADERA / EXTENSION / RALLONGE / VERLÄNGERUNG / PROLUNGA / EXTENÇÃO / УДЛИНИТЕЛЬ**

COD.	AF inch	L (mm)	g		
<b>73244</b>	1/4	50	28	5	•
<b>73245</b>		100	52		
<b>75204</b>		150	80		

⚠ 1000V | IEC 60900

**EXTENSIÓN CON MANGO / EXTENSION WITH HANDLE / GRANDE RALLONGE EMMANCHÉE / 4-KT. VERLÄNGERUNG MIT GRIFF / PROLUNGA CON IMPUGNATURA / EXTENSÃO COM CABO / УДЛИНИТЕЛЬ С РУКОЯТКОЙ**

COD.	AF inch	L (mm)	g		
<b>73256</b>	1/4	270	150	5	•

⚠ 1000V | IEC 60900

**MANGO EN T / T HANDLE / POIGNÉE T / T-GRIFF / IMPUGNATURA A T / PUNHO DE T / T-ОБРАЗНАЯ РУКОЯТКА**

COD.	AF inch	L (mm)	g		
<b>73243</b>	1/4	170	140	6	•

⚠ 1000V | IEC 60900

**BOQUILLA HEXAGONAL / HEXAGONAL SOCKET / DOUILLE HEXAGONALE / HEXAGONALE EINSÄTZE / BUSSOLA ESAGONALE / BICO HEXAGONAL / ГОЛОВКА С ШЕСТИГРАННИКОМ**

COD.	AF mm	g		
<b>73250</b>	3	16	10	•
<b>73251</b>	4	18		
<b>73252</b>	5	20		
<b>73253</b>	6	22		
<b>73254</b>	7	24		

⚠ 1000V | IEC 60900



1/4"

**JUEGOS LLAVES DE VASO / SOCKET WRENCHES SETS / SETS DOUILLES / WERKZEUGSÄTZE FÜR STECKSCHLÜSSEL / KIT BUSSOLE DOPPEN / JOGOS CHAVES DE CAIXA / НАБОР ГОЛОВКИ**

6 PCS.

STANDARD



COD.	PCS.	AF inch	AF inch	Medidas en / Sizes in / Mesures en		Kg
79067	6	1/4	8-10-12-13	mm	51079	850

PCS./UN.	Composición / Composition / Composition	Descripción / Description / Description	
1	73687	Carraca / Ratchet	1000V
4	73234, 73236, 73238, 73239	Vasos / Sockets	
1	73252	Boquilla hexagonal / Hexagonal sockets	5 mm - 1000V

10 PCS.

STANDARD

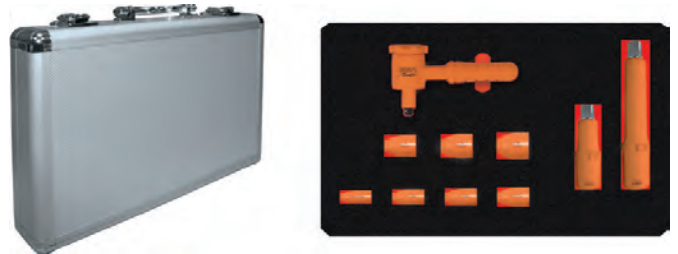

COD.	PCS.	AF inch	AF inch	Medidas en / Sizes in / Mesures en		Kg
79475	10	1/4	3/16-1/4-5/16-3/8-7/16-1/2-9/16	inch	51079	1

PCS./UN.	Composición / Composition / Composition	Descripción / Description / Description	
1	73687	Carraca / Ratchet	1000V
2	73244, 73245	Alargadera / Extension	
7	73367, 73369, 73371, 73373, 73374, 73375, 73376	Vasos / Sockets	

11 PCS.

STANDARD



COD.	PCS.	AF inch	AF inch	Medidas en / Sizes in / Mesures en		Kg
79068	11	1/4	6-7-8-9-10-11-12-13-14	mm	51079	950

PCS./UN.	Composición / Composition / Composition	Descripción / Description / Description	
1	73687	Carraca / Ratchet	1000V
9	73232, 73233, 73234, 73235, 73236, 73237, 73238, 73239, 73240	Vasos / Sockets	
1	73252	Boquilla hexagonal / Hexagonal sockets	5 mm - 1000V



COD.	PCS.	AF inch	AF inch	Medidas en / Sizes in / Mesures en		Kg
79476	10	1/4	3/16-1/4-5/16-3/8-7/16-1/2-9/16 (Serie larga) / (Long pattern) / (Série longue)	inch	51079	1,2

PCS./UN.	Composición / Composition / Composition	Descripción / Description / Description	
1	73687	Carraca / Ratchet	1000V
2	73244, 73245	Alargadera / Extension	
7	75085, 75087, 75089, 75091, 75092, 75093, 75094	Vasos (S.L.) / (L.S.) Sockets	

1/4"

16 PCS.

STANDARD



COD.	PCS.	AF inch	AF mm	Medidas en / Sizes in / Mesures en		
<b>79069</b>	16	1/4	4-5-6-7-8-9-10-11-12-13-14	mm	51053	1,5

PCS./UN.	Composición / Composition / Composition	Descripción / Description / Description	
1	73687	Carraca / Ratchet	1000V
	73245	Alargadera / Extension	
11	73230, 73231, 73232, 73233, 73234, 73235, 73236, 73237, 73238, 73239, 73240	Vasos / Sockets	
3	73251, 73252, 73253	Boquilla hexagonal / Hexagonal sockets	4-5-6 mm - 1000V

19 PCS.

STANDARD



COD.	PCS.	AF inch	AF mm	Medidas en / Sizes in / Mesures en		
<b>73014</b>	19	1/4	4-5-6-7-8-9-10-11-12-13-14	mm	51053	2

PCS./UN.	Composición / Composition / Composition	Descripción / Description / Description	
1	73687	Carraca / Ratchet	1000V
	73245	Alargadera / Extension	
	73256	Extensión con mango / Extension with handle	
11	73230, 73231, 73232, 73233, 73234, 73235, 73236, 73237, 73238, 73239, 73240	Vasos / Sockets	
5	73250, 73251, 73252, 73253, 73254	Boquilla hexagonal / Hexagonal sockets	3-4-5-6-7 mm - 1000V

21 PCS.

SERIE LARGA / LONG SOCKET / SÉRIE LONGUE / LANGE SERIE / SERIE LUNGA / SERIE LONGA / ВЫСОКАЯ СЕРИЯ

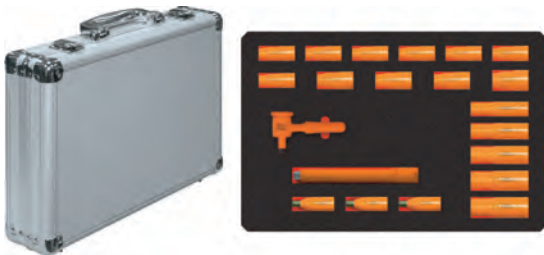

COD.	PCS.	AF inch	AF mm	Medidas en / Sizes in / Mesures en		
<b>79070</b>	21	1/4	4-5-6-7-8-9-10-11-12-13-14 (8-10-12-13-14 (Serie larga) / (Long pattern) / (Série longue)	mm	51053	1,8

PCS./UN.	Composición / Composition / Composition	Descripción / Description / Description	
1	73687	Carraca / Ratchet	1000V
	73245	Alargadera / Extension	
11	73230, 73231, 73232, 73233, 73234, 73235, 73236, 73237, 73238, 73239, 73240	Vasos / Sockets	
5	75056, 75058, 75060, 75061, 75062	Vasos (S.L.) / (L.S.) Sockets	
3	73251, 73252, 73253	Boquilla hexagonal / Hexagonal sockets	4-5-6 mm - 1000V

■ 3/8"

■ STANDARD

■ MM

■ 6 PT.

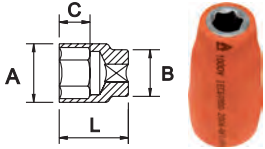

COD.	AF mm	L (mm)	A (mm)	B (mm)	C (mm)	Pt	g	
74914	6		11				20	
74915	7		12					
74916	8		13				25	
74917	9		14	17	12			
74918	10		15				31	
74919	11	27	16					
74920	12		17				33	
74921	13		18					
74922	14		20	18				
74923	15		22		14	6		10
74924	16		23	20			35	
74925	17		24	21				
74926	18	29	26	22	16		45	
74927	19							
74928	20		28	24			50	
74929	21						55	
74930	22	31	30	26	18		65	
74997	23						70	
74998	24		32	28			75	

⚡ 1000V | IEC 60900

■ 12 PT.

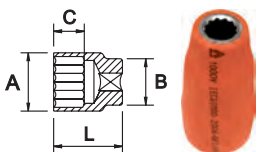

COD.	AF mm	L (mm)	A (mm)	B (mm)	C (mm)	Pt	g	
73261	8		13				25	
73262	9		14					
73263	10		15				31	
73264	11		16	17	12			
73265	12	27	17					
73266	13		18				33	
73267	14		20	18				
73268	15		22		14	12		10
73269	16		23	20			35	
73270	17		24	21				
73271	18	29	26	22	16		45	
73272	19							
73273	20		28	24			50	
73274	21	31	30	26	18		55	
73275	22						65	

⚡ 1000V | IEC 60900

■ INCH

■ 6 PT.

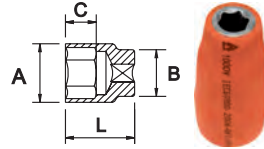

COD.	AF inch	L (mm)	A (mm)	B (mm)	C (mm)	Pt	g	
74940	1/4		12					
74941	9/32		13				25	
74942	5/16		14	17	12	6		10
74943	11/32	27	16				31	
74944	3/8		17					
74945	7/16		18				33	
74946	1/2		20	18	14			
74947	9/16							

⚡ 1000V | IEC 60900

■ 12 PT.

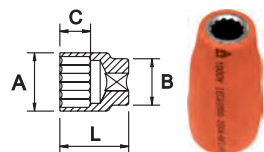

COD.	AF inch	L (mm)	A (mm)	B (mm)	C (mm)	Pt	g	
73477	1/4		12					
73478	5/16		13				25	
73479	11/32		14	17	12			
73480	3/8	27	16				31	
73481	7/16		17					
73482	1/2		18	18		12	33	10
73484	19/32		22	19	14		35	
73485	5/8							
73486	11/16	29	24	21			45	
73487	3/4		26	22	16		50	
73488	13/16	31	28	26	18		65	
73489	7/8							

⚡ 1000V | IEC 60900

3/8"

■ **SERIE LARGA / LONG SOCKET / SÉRIE LONGUE / LANGE SERIE / SERIE LUNGA / SERIE LONGA / ВЫСОКАЯ СЕРИЯ**

■ **MM**

■ **6 PT.**

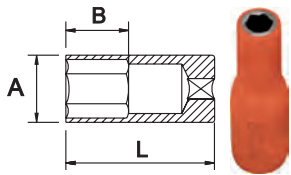

COD.	AF mm	L (mm)	A (mm)	B (mm)	Pt	g	
75115	7		12			90	
75116	8		13	12			
75117	9		14				
75118	10		15				
75119	11		16	14		95	
75120	12		18				
75121	13		20				
75122	14	62			6		10
75123	15		22	18		105	
75124	16		24				
75125	17		27			135	
75126	18		29			165	
75127	19		31	20		160	
75129	21					185	
75130	22					210	

⚡ 1000V | IEC 60900

■ **INCH**

■ **12 PT.**

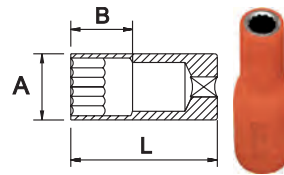

COD.	AF inch	L (mm)	A (mm)	B (mm)	Pt	g	
75160	1/4		11			90	
75161	5/16		13	12			
75162	3/8		15				
75163	7/16		17	14		95	
75164	1/2		19				
75165	9/16		21				
75166	19/32	62	22	18	12	105	10
75167	5/8		24			145	
75168	11/16		26			160	
75169	3/4		28	20		185	
75170	13/16		30			210	
75171	7/8						

⚡ 1000V | IEC 60900

■ **12 PT.**

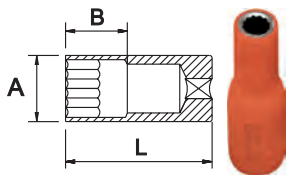

COD.	AF mm	L (mm)	A (mm)	B (mm)	Pt	g	
75140	7		12			90	
75141	8		13	12			
75142	9		14				
75143	10		15				
75144	11		16	14		95	
75145	12		18				
75146	13		20				
75147	14	62			12		10
75148	15		23	18		105	
75149	16		25			135	
75150	17		27			165	
75151	18		29			160	
75152	19		31	20		185	
75153	20						
75154	21						
75155	22						

⚡ 1000V | IEC 60900



3/8"

**LLAVE DE CARRACA REVERSIBLE / REVERSIBLE RATCHET HANDLE / CLÉ À CLIQUET RÉVERSIBLE / UMSCHALTKNARRE / CHIAVE A CRICCO REVERSIBILE / ROQUETE REVERSIVEL / РЕВЕРСИВНАЯ ТРЕЩЕТКА**

COD.	AF inch	L (mm)	g		
<b>73685</b>	3/8	200	390	6	•

 1000V I IEC 60900

**ALARGADERA / EXTENSION / RALLONGE / VERLÄNGERUNG / PROLUNGA / EXTENÇÃO / УДЛИНИТЕЛЬ**

COD.	AF inch	L (mm)	g		
<b>73276</b>		100	110		
<b>73280</b>	3/8	125	112	6	•
<b>73281</b>		250	290		

 1000V I IEC 60900

**BOQUILLA HEXAGONAL / HEXAGONAL SOCKET / DOUILLE HEXAGONALE / HEXAGONALE EINSÄTZE / BUSSOLA ESAGONALE / BICO HEXAGONAL / ГОЛОВКА С ШЕСТИГРАННИКОМ**

COD.	AF mm	g	
<b>73290</b>	3	42	
<b>73291</b>	4	44	
<b>73292</b>	5	46	
<b>73293</b>	6	50	10
<b>73294</b>	7	65	
<b>73295</b>	8		
<b>73296</b>	10	80	

 1000V I IEC 60900

**PUNTA CON CUADRADO GUIA TORX / SOCKET BIT TORX / EMBOUT TORX CARRÉ / STECKSCHLÜSSEL TORX / BUSSOLA CON PUNTA TORX / PONTEIRA TORX COM CHAVE DE CAIXA / ГОЛОВКА TORX ИЗОЛИРОВАННАЯ**

1/4"

COD.		L (mm)	g		
<b>79495</b>	T-20				
<b>79496</b>	T-25	55	20	10	•
<b>79497</b>	T-30		25		

**MANGO EN T / T HANDLE / POIGNÉE T / T-GRIFF / IMPUGNATURA A T / PUNHO DE T / Т-ОБРАЗНАЯ РУКОЯТКА**

COD.	AF inch	L (mm)	g		
<b>73283</b>	3/8	200	600	6	•

 1000V I IEC 60900

**ADAPTADOR / ADAPTER / ADAPTATEUR / VERBINDUNGSTEILE / ADATTATORE / REDUTOR / АДАПТОР**

COD.	AF inch	AF inch	g		
<b>73284</b>	3/8-1/2		47	5	•

 1000V I IEC 60900

COD.	AF inch	AF inch	g		
<b>73285</b>	3/8-1/4		65	5	•

 1000V I IEC 60900

3/8"

**JUEGOS LLAVES DE VASO / SOCKET WRENCHES SETS / SETS DOUILLES / WERKZEUGSÄTZE FÜR STECKSCHLÜSSEL / KIT BUSSOLE DOPPEN / JOGOS CHAVES DE CAIXA / НАБОР ГОЛОВКИ**

8 PCS.

STANDARD



COD.	PCS.	AF inch	AF mm	Medidas en / Sizes in / Mesures en		
<b>79071</b>	8	3/8	8-10-13-17	mm	51079	1,5

PCS./UN.	Composición / Composition / Composition	Descripción / Description / Description	
1	73685	Carraca / Ratchet	1000V
4	74916, 74918, 74921, 74925	Vasos / Sockets	
2	73291, 73292	Boquilla hexagonal / Hexagonal sockets	4-5 mm - 1000V
1	73280	Alargadera / Extension	1000V

10 PCS.

STANDARD



COD.	PCS.	AF inch	AF mm	Medidas en / Sizes in / Mesures en		
<b>79072</b>	10	3/8	8-10-13-14-17-19-21	mm	51053	2

PCS./UN.	Composición / Composition / Composition	Descripción / Description / Description	
1	73685	Carraca / Ratchet	1000V
7	74916, 74918, 74921, 74922, 74925, 74927, 74929	Vasos / Sockets	
1	73292	Boquilla hexagonal / Hexagonal sockets	5 mm - 1000V
	73280	Alargadera / Extension	1000V



COD.	PCS.	AF inch	AF mm	Medidas en / Sizes in / Mesures en		
<b>79437</b>	8	3/8	1/4-5/16-3/8-1/2	inch	51079	1,5

PCS./UN.	Composición / Composition / Composition	Descripción / Description / Description	
1	73685	Carraca / Ratchet	1000V
4	73477, 73478, 73480, 73482	Vasos / Sockets	
2	73291, 73292	Boquilla hexagonal / Hexagonal sockets	4-5 mm - 1000V
1	73280	Alargadera / Extension	1000V





COD.	PCS.	AF inch	AF mm	Medidas en / Sizes in / Mesures en		
<b>79477</b>	10	3/8	3/8-7/16-1/2-5/8-11/16-3/4-13/16	inch	51053	2,5

PCS./UN.	Composición / Composition / Composition	Descripción / Description / Description	
1	73685	Carraca / Ratchet	1000V
2	73276, 73280	Alargadera / Extension	
7	73480, 73481, 73482, 73485, 73486, 73487, 73488	Vasos / Sockets	

3/8"

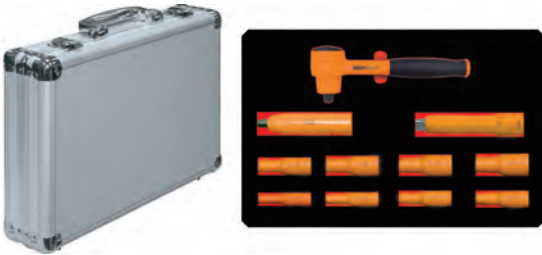
11 PCS.



**SERIE LARGA / LONG SOCKET / SÉRIE LONGUE / LANGE SERIE / SERIE LUNGA / SERIE LONGA / ВЫСОКАЯ СЕРИЯ**

COD.	PCS.	AF inch	AF inch	Medidas en / Sizes in / Mesures en		
<b>79478</b>	11	3/8	3/8-7/16-1/2-9/16-5/8-11/16-3/4-13/16"	(Serie larga) / (Long pattern) / (Série longue)	inch	51053 2,8

PCS./UN.	Composición / Composition / Composition	Descripción / Description / Description	
1	73685	Carraca / Ratchet	1000V
2	73276, 73280	Alargadera / Extension	
8	75162, 75163, 75164, 75165, 75167, 75168, 75169, 75170	Vasos (S.L.) / (L.S.) Sockets	

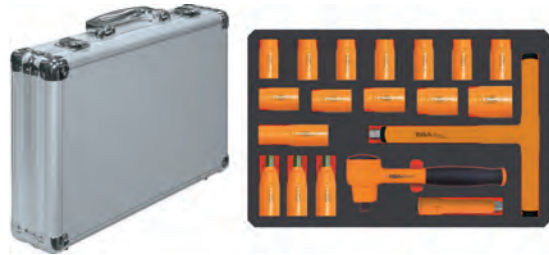
19 PCS.

**SERIE LARGA / LONG SOCKET / SÉRIE LONGUE / LANGE SERIE / SERIE LUNGA / SERIE LONGA / ВЫСОКАЯ СЕРИЯ**



COD.	PCS.	AF inch	AF mm	Medidas en / Sizes in / Mesures en		
<b>73015</b>	19	3/8	6-7-8-9-10-11-12-13-14-17-19-21 (10)	(Serie larga) / (Long pattern) / (Série longue)	mm	51053 3,3

PCS./UN.	Composición / Composition / Composition	Descripción / Description / Description	
1	73685	Carraca / Ratchet	1000V
	73280	Alargadera / Extension	
	73283	Mango en T / T Handle	
12	74914, 74915, 74916, 74917, 74918, 74919, 74920, 74921, 74922, 74925, 74927, 74929	Vasos / Sockets	
1	75118	Vasos (S.L.) / (L.S.) Sockets	
3	73291, 73292, 73294	Boquilla hexagonal / Hexagonal sockets	4-5-7 mm - 1000V

26 PCS.

STANDARD



COD.	PCS.	AF inch	AF mm	Medidas en / Sizes in / Mesures en		
<b>79073</b>	26	3/8	6-7-8-9-10-11-12-13-14-16-17-18-19-20-21-22-23-24		mm	51053 4,2

PCS./UN.	Composición / Composition / Composition	Descripción / Description / Description	
1	73685	Carraca / Ratchet	1000V
18	74914, 74915, 74916, 74917, 74918, 74919, 74920, 74921, 74922, 74924, 74925, 74926, 74927, 74928, 74929, 74930, 74997, 74998	Vasos / Sockets	
4	73291, 73292, 73293, 73295	Boquilla hexagonal / Hexagonal sockets	
1	73281	Alargadera / Extension	
2	73284, 73285	Adaptador / Adapter	

- 1/2"
- STANDARD
- MM
- 6 PT.

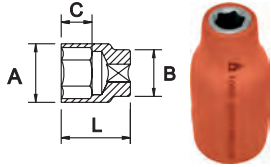

- 12 PT.

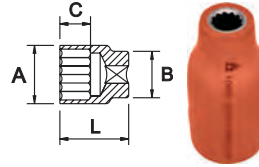

COD.	AF mm	L (mm)	A (mm)	B (mm)	C (mm)	Pt	g	Icon
74960	8		14				50	
74961	9		15		5,0		50	
74962	10		16		6,0			
74963	11		17		7,0			
74964	12		18	21	8,0		55	
74965	13		19					
74966	14		21					
74967	15		22		10		60	
74968	16	40	24	22			70	
74969	17		26	23				
74970	18		28	26	12		90	
74971	19		30	26		6		10
74972	-	20	32					
74973	-	21	32	31			110	
74974	22		30		14		95	
74975	-	23	32					
74976	24		32	31			110	
74977	-	25	34		16		140	
74978	-	26	34				150	
74979	27	44	36		18		160	
74980	-	28	38	34			170	
74981	-	29	40		20		180	
74982	30	45	40				200	
74983	32		42	38	22		210	

COD.	AF mm	L (mm)	A (mm)	B (mm)	C (mm)	Pt	g	Icon
73400	8		14				50	
73401	9		15		5,0		50	
73402	10		16		6,0			
73403	11		17		7,0			
73404	12		18	21	8,0		55	
73405	13		19					
73406	14		21					
73407	15		22		10		60	
73408	16	40	24	22			70	
73409	17		26	23				
73410	18		28	26	12		90	
73411	19		30	26		12		10
73412	20		32					
73413	21		30		14		95	
73414	22		32					
74991	23		32	31			110	
73416	24		34		16		140	
74992	25	44	36				150	
74993	26		36		18		160	
73417	27		38	34			170	
74994	28		40		20		180	
74995	29	45	42	38	22		200	
73420	30		42					
73421	32		42	38	22		210	

1000V | IEC 60900

1000V | IEC 60900

1/2"

■ INCH

■ 6 PT.

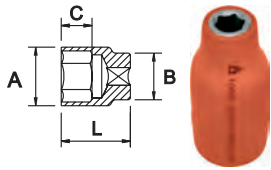

■ 12 PT.

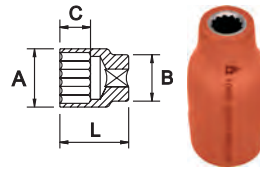

COD.	AF inch	L (mm)	A (mm)	B (mm)	C (mm)	Pt	g	
75000	5/16		15				45	
75001	3/8		16				50	
75002	7/16		17				55	
75003	1/2		18	22	14			
75004	9/16		21					
75005	19/32		22				60	
75006	5/8		22					
75007	21/32	38	24	23			70	
75008	11/16		24	24	16		80	
75009	3/4		26	26		6	90	10
75010	25/32		28				110	
75011	13/16		28	28	20			
75012	7/8		30				120	
75013	15/16		32				130	
75014	31/32		32				140	
75015	1		30				145	
75016	1.1/16	42	36		24		160	
75017	1.1/8		38				170	
75018	1.3/16	45	40	31	28		180	
75019	1.1/4						200	

COD.	AF inch	L (mm)	A (mm)	B (mm)	C (mm)	Pt	g	
73491	5/16		15				45	
73492	3/8		16				50	
73493	7/16		17				55	
73494	1/2		18	22	14			
73495	9/16		21					
73496	19/32		22				60	
73497	5/8		22					
73498	21/32	38	24	23			70	
73499	11/16		24	24	16		80	
73500	3/4		26	26		12	90	10
75025	25/32		28				110	
73501	13/16		28	28	20			
73502	7/8		30				120	
73503	15/16		32				130	
75028	31/32		32				140	
75029	1		30				145	
75030	1.1/16	42	36		24		160	
75031	1.1/8		38				170	
75032	1.3/16	45	40	31	28		180	
75033	1.1/4						200	

⚡ 1000V | IEC 60900

⚡ 1000V | IEC 60900



1/2"

■ **SERIE LARGA / LONG SOCKET / SÉRIE LONGUE / LANGE SERIE / SERIE LUNGA / SERIE LONGA / ВЫСОКАЯ СЕРИЯ**

■ **MM**

■ **6 PT.**

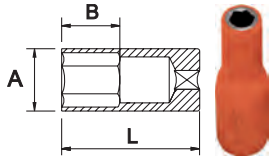

COD.	AP mm	L (mm)	A (mm)	B (mm)	Pt	g	
73430	10		17	9,0			
73431	11		18	11			
73432	12		19	12			
73433	13		21	12	140		
73434	14		22				
73435	15		23	15			
73436	16						
73437	17		24		150		
73438	18		26		180		
73439	19	75	28	18	200	10	
73440	21		30		250		
73441	22		32	21	280		
73442	23		34	24	370		
73443	24		36		430		
73444	26		38	27	450		
73445	27		40	30	500		
73446	28		42				

⊕ 1000V | IEC 60900

■ **12 PT.**

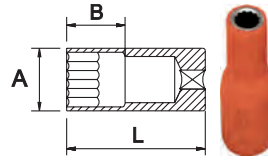

COD.	AP mm	L (mm)	A (mm)	B (mm)	Pt	g	
75180	10		17	9,0			
75181	11		18	11			
75182	12		19	12			
75183	13		21	12	140		
75184	14		22				
75185	15		23	15			
75186	16		24		150		
75187	17		26		180		
75188	18	75	28	18	200	10	
75189	19		30		250		
75190	21		32	21	280		
75191	22		34	24	370		
75192	23		36		430		
75193	24		38	27	450		
75194	26		40	30	520		
75195	27		42				
75196	28						
75197	29						
75198	30						
75199	32						

⊕ 1000V | IEC 60900

■ **INCH**

■ **6 PT.**

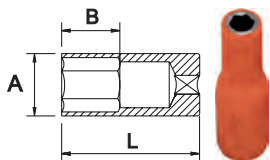

COD.	AP inch	L (mm)	A (mm)	B (mm)	Pt	g	
73378	3/8		17	6,0			
73379	7/16		19	7,0			
73380	1/2		20	8,0	140		
73381	9/16		22	10			
73382	5/8	75	24	15	6	150	10
73383	11/16		26		170		
73384	3/4		28	18	200		
73385	13/16		30	21	250		
73386	7/8		32	24	290		

⊕ 1000V | IEC 60900

■ **12 PT.**

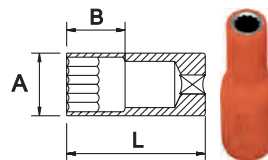

COD.	AP inch	L (mm)	A (mm)	B (mm)	Pt	g	
75215	3/8		17	6,0			
75216	7/16		19	7,0			
75217	1/2		20	8,0	140		
75218	9/16		22	10			
75219	5/8	75	24	15	12	150	10
75220	11/16		26		170		
75221	3/4		28	18	200		
75222	13/16		30	21	250		
75223	7/8		32	24	290		
75224	15/16		36	24	330		
75225	1		38		380		
75226	1.1/16				410		
75227	1.1/8						

⊕ 1000V | IEC 60900

1/2"

**LLAVE DE CARRACA REVERSIBLE / REVERSIBLE RATCHET HANDLE / CLÉ À CLIQUET RÉVERSIBLE / UMSCHALTKNARRE / CHIAVE A CRICCO REVERSIBILE / ROQUETE REVERSIVEL / РЕВЕРСИВНАЯ ТРЕЩЕТКА**

N!

COD.	AF inch	L (mm)	g		
<b>73683</b>	1/2	235	645	6	•

 1000V | IEC 60900

**ALARGADERA / EXTENSION / RALLONGE / VERLÄNGERUNG / PROLUNGA / EXTENÇÃO / УДЛИНИТЕЛЬ**

COD.	AF inch	L (mm)	g		
<b>73445</b>	1/2	125	260	5	•
<b>73446</b>		250	360		

 1000V | IEC 60900

**MANGO EN T / T HANDLE / POIGNÉE T / T-GRIFF / IMPUGNATURA A T / PUNHO DE T / Т-ОБРАЗНАЯ РУКОЯТКА**

COD.	AF inch	L (mm)	g		
<b>73448</b>	1/2	200	600	6	•

 1000V | IEC 60900

**BOQUILLA HEXAGONAL / HEXAGONAL SOCKET / DOUILLE HEXAGONALE / HEXAGONALE EINSÄTZE / BUSSOLA ESAGONALE / BICO HEXAGONAL / ГОЛОВКА С ШЕСТИГРАННИКОМ**

COD.	AF mm	g	
<b>73455</b>	4	75	10
<b>73456</b>	5		
<b>73457</b>	6		
<b>73458</b>	7	80	
<b>73459</b>	8		
<b>73460</b>	9	90	
<b>73461</b>	10		
<b>73462</b>	11	135	
<b>73463</b>	12		
<b>73464</b>	13	160	
<b>73465</b>	14		
<b>73468</b>	17		

 1000V | IEC 60900

**ADAPTADOR / ADAPTER / ADAPTATEUR / VERBINDUNGSTEILE / ADATTATORE / REDUTOR / АДАПТОР**

COD.	AF inch	AF inch	g		
<b>73286</b>	1/2-1/4		80	5	•
<b>73449</b>	1/2-3/8				

 1000V | IEC 60900



1/2"

**JUEGOS LLAVES DE VASO / SOCKET WRENCHES SETS / SETS DOUILLES / WERKZEUGSÄTZE FÜR STECKSCHLÜSSEL / KIT BUSSOLE DOPPEN / JOGOS CHAVES DE CAIXA / НАБОР ГОЛОВКИ**

10 PCS.

STANDARD





COD.	PCS.	AF inch	AF mm	Medidas en / Sizes in / Mesures en		
<b>79074</b>	10	1/2	8-10-13-17-18- 19-21-22	mm	51053	3

PCS./UN.	Composición / Composition / Composition	Descripción / Description / Description	
1	73683	Carraca / Ratchet	
8	73400, 73402, 73405, 73409, 73410, 73411, 73413, 73414	Vasos / Sockets	1000V
1	73445	Alargadera / Extension	

12 PCS.

STANDARD





COD.	PCS.	AF inch	AF mm	Medidas en / Sizes in / Mesures en		
<b>79479</b>	12	1/2	1/2-9/16-5/8-11/16- 3/4-13/16-7/8- 15/16-1	inch	51053	3,2

PCS./UN.	Composición / Composition / Composition	Descripción / Description / Description	
1	73683	Carraca / Ratchet	
2	73445, 73446	Alargadera / Extension	
9	73494, 73495, 73497, 73499, 73500, 73501, 73502, 73503, 75029	Vasos / Sockets	1000V

14 PCS.



STANDARD



COD.	PCS.	AF inch	AF mm	Medidas en / Sizes in / Mesures en		
<b>79075</b>	14	1/2	8-9-10-11-12-13-14- 17-19-21-22-23	mm	51053	3,5

PCS./UN.	Composición / Composition / Composition	Descripción / Description / Description	
1	73683	Carraca / Ratchet	
12	73400, 73401, 73402, 73403, 73404, 73405, 73406, 73409, 73411, 73413, 73414, 74991	Vasos / Sockets	1000V
1	73445	Alargadera / Extension	

**SERIE LARGA / LONG SOCKET / SÉRIE LONGUE / LANGE SERIE / SERIE LUNGA / SERIE LONGA / ВЫСОКАЯ СЕРИЯ**

COD.	PCS.	AF inch	AF mm	Medidas en / Sizes in / Mesures en		
<b>79480</b>	12	1/2	1/2-9/16-5/8-11/16- 3/4-13/16-7/8-15/16- 1 (Serie larga) / (Long pattern) / (Série longue)	inch	51054	6,6

PCS./UN.	Composición / Composition / Composition	Descripción / Description / Description	
1	73683	Carraca / Ratchet	
2	73445, 73446	Alargadera / Extension	
9	75217, 75218, 75219, 75220, 75221, 75222, 75223, 75224, 75225	Vasos (S.L.) / (L.S.) Sockets	1000V



1/2"

15 PCS.

SERIE LARGA / LONG SOCKET / SÉRIE LONGUE / LANGE SERIE / SERIE LUNGA / SERIE LONGA / ВЫСОКАЯ СЕРИЯ

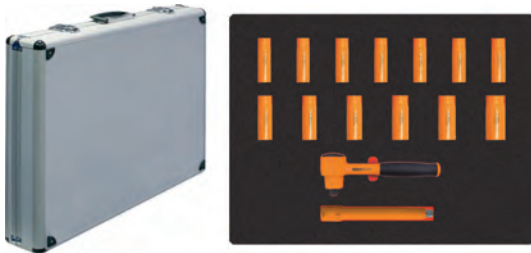

COD.	PCS.	AF inch	AF mm	Medidas en / Sizes in / Mesures en		Kg
<b>79076</b>	15	1/2		10-12-13-14-15-16-17-18-19-21-22-23-27 (Serie larga) / (Long pattern) / (Série longue)	mm	51054 7

PCS./UN.	Composición / Composition / Composition	Descripción / Description / Description	
1	73683	Carraca / Ratchet	
13	75180, 75182, 75183, 75184, 75185, 75186, 75187, 75188, 75189, 75191, 75192, 75193, 75196	Vasos (S.L.) / (L.S.) Sockets	1000V
1	73446	Alargadera / Extension	

18 PCS.

STANDARD



COD.	PCS.	AF inch	AF mm	Medidas en / Sizes in / Mesures en		Kg
<b>73017</b>	18	1/2 - 1/4		6-7 (1/4"); 8-9-10-11-12-13-14-16-17-18-19-21-23	mm	51053 3

PCS./UN.	Composición / Composition / Composition	Descripción / Description / Description	
1	73683	Carraca / Ratchet	
2	73445	Alargadera / Extension	
15	73232, 73233		1000V
	73400, 73401, 73402, 73403, 73404, 73405, 73406, 73408, 73409, 73410, 73411, 73413, 74991	Vasos / Sockets	
1	73286	Adaptador / Adapter	1/2"-1/4"

31 PCS.

STANDARD

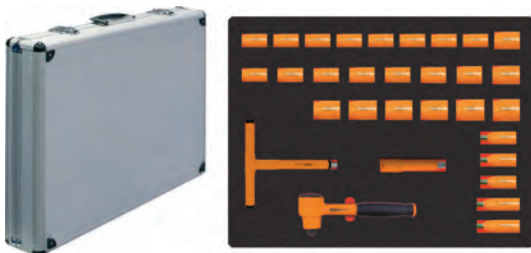

COD.	PCS.	AF inch	AF mm	Medidas en / Sizes in / Mesures en		Kg
<b>79077</b>	31	1/2		8-9-11-12-13-14-15-16-17-18-19-20-21-22-23-24-25-26-27-28-29-30-32	mm	51054 10

PCS./UN.	Composición / Composition / Composition	Descripción / Description / Description	
1	73683	Carraca / Ratchet	
23	73400, 73401, 73403, 73404, 73405, 73406, 73407, 73408, 73409, 73410, 73411, 73412, 73413, 73414, 74991, 73416, 74992, 74993, 73417, 74994, 74995, 73420, 73421	Vasos / Sockets	1000V
5	73459, 73461, 73463, 73465, 73468	Boquilla hexagonal / Hexagonal sockets	8-10-12-14-17 mm - 1000V
1	73445	Alargadera / Extension	1000V
1	73448	Mango en T / T Handle	

32 PCS.

STANDARD



COD.	PCS.	AF inch	AF mm	Medidas en / Sizes in / Mesures en		Kg
<b>73016</b>	32	1/2		8-9-10-11-12-13-14-15-16-17-18-19-20-21-22-23-24-25-26-27-28-29-30-32	mm	51053 7,3

PCS./UN.	Composición / Composition / Composition	Descripción / Description / Description	
1	73683	Carraca / Ratchet	
	73445	Alargadera / Extension	
24	73400, 73401, 73402, 73403, 73404, 73405, 73406, 73407, 73408, 73409, 73410, 73411, 73412, 73413, 73414, 74991, 73416, 74992, 74993, 73417, 74994, 74995, 73420, 73421	Vasos / Sockets	1000V
5	73459, 73461, 73463, 73465, 73468	Boquilla hexagonal / Hexagonal sockets	8-10-12-14-17 mm - 1000V

01

1000V



1/2"

37 PCS.

SERIE LARGA / LONG SOCKET / SÉRIE LONGUE / LANGE SERIE / SERIE LUNGA / SERIE LONGA / ВЫСОКАЯ СЕРИЯ



COD.	PCS.	AF inch	AF mm	Medidas en / Sizes in / Mesures en			
79078	37	1/2		8-9-11-12-13-14- 15-16-17-18-19-20- 21-22-23-24-25- 26-27-28-29-30-32 (10-13-17-19 (Serie larga)) / (Long pattern)) / (Série longue)	mm	51054	10,2

PCS./UN.	Composición / Composition / Composition	Descripción / Description / Description	
1	73683	Carraca / Ratchet	
23	73400, 73401, 73403, 73404, 73405, 73406, 73407, 73408, 73409, 73410, 73411, 73412, 73413, 73414, 74991, 73416, 74992, 74993, 73417, 74994, 74995, 73420, 73421	Vasos / Sockets	1000V
4	73430, 73433, 73437, 73439	Vasos (S.L.) / (L.S.) Sockets	
1	73449	Adaptador / Adapter	1/2"-3/8" - 1000V
6	73457, 73459, 73462, 73463, 73464, 73465	Boquilla hexagonal / Hexagonal sockets	6-8-11-12-13-14 mm - 1000V
1	73445	Alargadera / Extension	1000V
	73448	Mango en T / T Handle	



# EGA Master

## ART IN INNOVATION

**GUANTES AISLANTES / INSULATING GLOVES / GANTS ISOLANTS / SCHUTZHANDSCHUHE, ISOLIERT / GUANTI ISOLATE / LUVAS ISOLADAS / ИЗОЛЯЦИОННЫЕ ПЕРЧАТКИ**

COD.	Clase / Class / Classe	Tensión de prueba (V) / Proof test voltage (V) / Tension d'essai (V)	Tensión de uso (V) / Use voltage (V) / Tension d'utilisation (V)	Tensión de resistencia (V) / Resistance voltage (V) / Tension de résistance (V)	L (mm)	Talla / Size / Taille	Categoría / Category / Catégorie	
73746						7		
73539						8		
73540	00	2.500	500	5.000		9		150
73541						10		
73542						11		
73748						7		
73553						8	AZC	
73554	0	5.000	1.000	10.000		9		250
73555						10		
73556						11		
73557					360	8		
73558	1	10.000	7.500	20.000		9		350
73559						10		
73560						11		
73561						8		
73562	2	20.000	17.000	30.000		9		500
73563						10		
73564						11		
73565						8		
73566	3	30.000	26.500	40.000		9	RC	700
73567						10		
73568						11		
73569						9		
73570	4	40.000	36.000	50.000	410	10		850
73571						11		

**Resistente a: / Resistant to: / Résistance à:**

<b>A</b>	Ácido / Acid / Acide
<b>Z</b>	Ozono / Ozone / Ozone
<b>H</b>	Aceite / Oil / Huile
<b>C</b>	Muy baja temperatura / Extremely low temperature / Très basse température
<b>R</b>	A+Z+H

**CE**  **1000V** | IEC 60900

ALMACENAJE / STORAGE / EMBALLAGE	Los guantes se deberán almacenar en su empaquetado original a una temperatura ambiente entre +5° y +35°C, en un lugar seco y oscuro, sin exposición directa a la luz solar, artificial u otras fuentes de ozono. <i>Gloves should be stored in their original package at a temperature between +5°C and +35°C in a dark and dry place, not exposed to direct sunlight, artificial light or sources of ozone.</i> Les gants devront être gardés dans leur emballage d'origine à une température ambiante comprise entre +5° et +35°C, dans un lieu sec et obscur, sans exposition directe au rayon du soleil, à la lumière artificielle ou toutes autres sources d'ozone.
INSPECCIÓN / INSPECTION / INSPECTION	Antes de cada uso, llevar a cabo una inspección visual y comprobar el guante inflándolo para detectar posibles daños. Cualquier punción o perforación lo hace inutilizable. <i>Before each use, make a visual inspection and inflate the glove to detect possible damages. Any hole or perforation make it useless.</i> Avant chaque utilisation, réalisez une inspection visuelle et testez le gant en le gonflant afin de détecter d'éventuels dommages. Toute ponction ou perforation rend le gant inutilisable.
LIMPIEZA / CLEANING / NETTOYAGE	Usar agua y jabón para limpiarlos. <i>Use water and soap to clean them.</i> Utiliser de l'eau et du savon pour le nettoyage.

Se recomienda comprobar todos los guantes aislantes cada seis meses / *Testing the insulating gloves every six months is advisable* / Il est recommandé de tester les gants isolants tous les six mois.

**SOBREGUANTES DE CUERO / LEATHER OVERGLOVES / SURGANTS CUIR / LEDER ÜBERHANDSCHUHE / SOPRAGUANTI IN PELLE / SOBRE-LUVA DE COURO / ЗАЩИТНЫЕ НАКЛАДНЫЕ ПЕРЧАТКИ КОЖАНЫЕ**

COD.	L (mm)	Clase / Class / Classe	Talla / Size / Taille	Válido para / Valid for / Valable pour	
57121	280	00 (7)   0 (7)	7	73746, 73748	
57122	290	00 (8)   00 (9)   0 (8)   0 (9)	8   9	73539, 73540, 73553, 73554	
57123	300	00 (10)   0 (10)   1 (8)   1 (9)   2 (8)   2 (9)	8   9   10	73541, 73555, 73557, 73558, 73561, 73562	
57124	310	00 (11)   0 (11)   1 (10)	10   11	73559, 73542, 73556	175
57125	330	1 (11)   2 (10)   3 (8)   3 (9)   4 (9)	8   9   10   11	73560, 73563, 73565, 73566, 73569	
57144	340	2 (11)   3 (10)   4 (10)	10   11	73564, 73567, 73570	
57145	350	3 (11)   4 (11)	11	73568, 73571	

Para su uso sobre los guantes aislantes con el fin protegerlos de los riesgos mecánicos, y si fuere el caso contra los riesgos de arco eléctrico. / *Designed for its use over insulating gloves to protect against mechanical risks and, when necessary, against electric arc risks.* / Pour les porter sur les gants isolants afin de les protéger des risques mécaniques et le cas échéant contre les risques d'arc électrique.



**GUANTES AISLANTES COMPOSITE / COMPOSITE INSULATING GLOVES / GANTS ISOLANTS COMPOSITES / KOMPOZIT ISOLIERHANDSCHUHE / GUANTI ISOLATI IN COMPOSITO / LUVAS ISOLANTES COMPOSITE / ИЗОЛИРУЮЩИЕ ПЕРЧАТКИ КОМПОЗИТНЫЕ**

COD.	Clase / Class / Classe	Tensión de prueba (V) / Proof test voltage (V) / Tension d'essai (V)	Tensión de uso (V) / Use voltage (V) / Tension d'utilisation (V)	Tensión de resistencia (V) / Resistance voltage (V) / Tension de résistance (V)	L (mm)	Talla / Size / Taille	Categoría / Category / Catégorie	g
79734	0	5.000	1.000	10.000	360	7	600	
79735						8		
79736						9		
79737						10		
79738						11		
79739						12		
79740	1	10.000	7.500	20.000	410	8	650	
79741						9		
79742						10		
79743						11		
79744	2	20.000	17.000	30.000	410	12	700	RC
79745						8		
79746						9		
79747	3	30.000	26.500	40.000	410	10	800	
79748						11		
79749						12		
79750	4	40.000	36.000	50.000	410	8	1100	
79751						9		
79752						10		
79753						11		
79754	4	40.000	36.000	50.000	410	12	1100	
79755						8		
79756						9		
79757	4	40.000	36.000	50.000	410	10	1100	
79758						11		
79759	12							

**Resistente a: / Resistant to: / Résistance à:**

<b>A</b>	Ácido / Acid / Acide
<b>Z</b>	Ozono / Ozone / Ozone
<b>H</b>	Aceite / Oil / Huile
<b>C</b>	Muy baja temperatura / Extremely low temperature / Très basse température
<b>R</b>	A+Z+H

 CE  1000V I IEC 60900

**CARACTERÍSTICAS / FEATURES / CARACTÉRISTIQUES**

Protección eléctrica y mecánica / Electrical and mechanical protection / Protection électrique et mécanique

ALMACENAJE / STORAGE / EMBALLAGE	<p>Los guantes se deberán almacenar en su empaquetado original a una temperatura ambiente entre +5° y +35°C, en un lugar seco y oscuro, sin exposición directa a la luz solar, artificial u otras fuentes de ozono.</p> <p><i>Gloves should be stored in their original package at a temperature between +5°C and +35°C in a dark and dry place, not exposed to direct sunlight, artificial light or sources of ozone.</i></p> <p>Les gants devront être gardés dans leur emballage d'origine à une température ambiante comprise entre +5° et +35°C, dans un lieu sec et obscur, sans exposition directe au rayon du soleil, à la lumière artificielle ou toutes autres sources d'ozone.</p>
INSPECCIÓN / INSPECTION / INSPECTION	<p>Antes de cada uso, llevar a cabo una inspección visual y comprobar el guante inflándolo para detectar posibles daños. Cualquier punción o perforación lo hace inutilizable.</p> <p><i>Before each use, make a visual inspection and inflate the glove to detect possible damages. Any hole or perforation make it useless.</i></p> <p>Avant chaque utilisation, réalisez une inspection visuelle et testez le gant en le gonflant afin de détecter d'éventuels dommages. Toute ponction ou perforation rend le gant inutilisable.</p>
LIMPIEZA / CLEANING / NETTOYAGE	<p>Usar agua y jabón para limpiarlos.</p> <p><i>Use water and soap to clean them.</i></p> <p>Utiliser de l'eau et du savon pour le nettoyer.</p>

Se recomienda comprobar todos los guantes aislantes cada seis meses / Testing the insulating gloves every six months is advisable / Il est recommandé de tester les gants isolants tous les six mois.

■ **ACCESORIOS / ACCESORIES / ACCESSOIRES / ERSATZTEILE / ACCESSORI / ACESSORIOS / ЗАПАСНЫЕ ЧАСТИ**

■ **CAJAS DE TRANSPORTE / TRANSPORT BOXES / CAISSES DE TRANSPORT / TRANSPORTKISTEN / ASTUCCIO PER IL TRASPORTO / CAIXAS DE TRANSPORTE / КЕЙСЫ ДЛЯ ТРАНСПОРТИРОВКИ**

COD.	L x W x H (mm)	
<b>58918</b>	500x250x100	1100



COD.	L x W x H (mm)	
<b>58919</b>	500x250x100	1100



**ESPECIFICACIONES TÉCNICAS / TECHNICAL SPECIFICATION / DÉTAILS TECHNIQUES**

Accesorios incluidos / Accessories Included / Accessoires inclus

Bote de talco / Talc  
Bottle / Talc en flacon

■ **MANTENIMIENTO / MAINTENANCE / MAINTENANCE / INSTANDHALTUNG / MANTENIMIENTO / MANUTENÇÃO / ОБСЛУЖИВАНИЕ**

■ **LIMPIADOR PARA GANTES Y ALFOMBRAS AISLANTES / CLEANER FOR GLOVES AND INSULATING CARPETS / NETTOYANT POUR GANTS ET TAPIS ISOLANTS / REINIGER FÜR HANDSCHUHE UND ISOLIERTE TEPPICHE / PULITORE PER GUANTI E TAPPETI ISOLATI / PRODUTO DE LIMPEZA PARA LUVAS E TAPETES ISOLANTES / ОЧИСТИТЕЛЬ ДЛЯ РУКАВИЦ**

COD.	CAP. (ml)	
<b>58920</b>	750	750

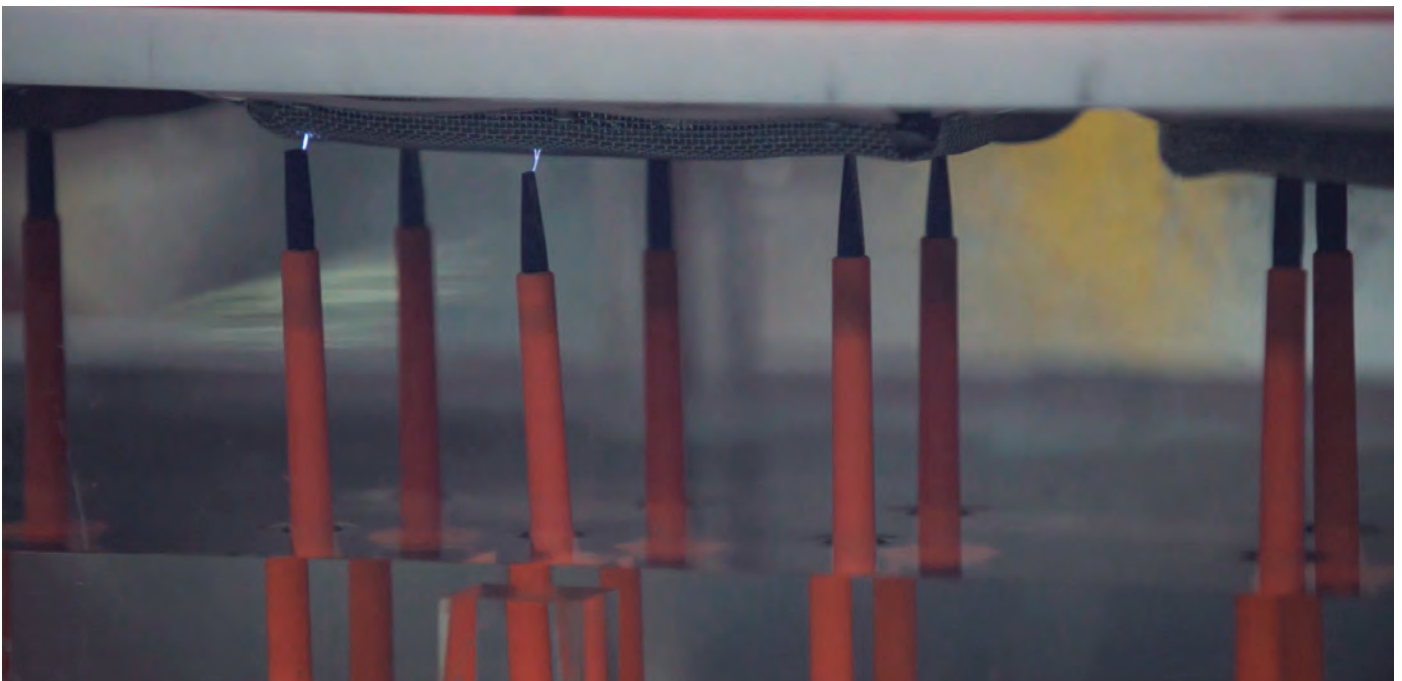





**TESTER PARA GUANTES / GLOVE TESTER / TESTEUR POUR GANTS / HANDSCHUH-PRÜFER / TESTER PER GUANTI / TESTER PARA LUVAS / ПНЕВМАТИЧЕСКИЙ ТЕСТЕР ДЛЯ РУКАВИЦ**

COD.	Clase / Class / Classe		Pt
73490	Clase 00-Class 0 / Class 00-Class 0 / Classe 00-Classe 0	0,6	360

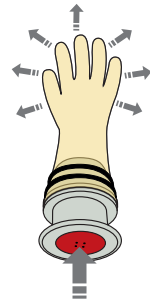
**CARACTERÍSTICAS / FEATURES / CARACTÉRISTIQUES**

El tester neumático solamente es apto para su uso con guantes de bajo voltage (clase 00 & clase 0) / The pneumatic tester can be only used for the low voltage gloves (class 00 and class 0) / Le testeur pneumatique est seulement utilisable avec des gants basse tension (classe 00 et classe 0)





**ALFOMBRAS AISLANTES / INSULATING CARPETS / TAPIS ISOLANTS / ISOLIERTEPPISCH / TAPPETO ISOLATO / TAPETES ISOLANTES / ДИЭЛЕКТРИЧЕСКИЙ КОВРИК**

COD.		L x W (mm)	Resistencia dieléctrica (kV) / Dielectric Resistance (kV) / Résistance diélectrique (kV)		
73505	3	600 x 600	30	1,4	1
73506		600 x 1000		2,3	
73507		600 x 5000		12	
73508		600 x 10000		23	
73514		1200 x 1000		4,7	
73515		1200 x 2000		9,5	
73516	1200 x 5000	23			
73517	1200 x 10000	47			
73518	4,5	600 x 1000	50	3,1	
73519		600 x 5000		15	
73520		600 x 10000		31	
73521		1200 x 1000		5,0	
73522		1200 x 5000		26	
73524		1200 x 10000		60	



1000V | IEC-EN 60243-1

**MANTAS AISLANTES / INSULATING BLANKETS / COUVERTURES ISOLANTES / ISOLIERENDE DECKEN / TAPPETI ISOLANTI / MANTAS ISOLANTES / ИЗОЛИРУЮЩАЯ ТКАНЬ**

COD.		LxW (mm)	Resistencia dieléctrica (kV) / Dielectric Resistance (kV) / Résistance diélectrique (kV)	Clase / Class / Classe		
79801	0,3	470x350	0,1	0	0,125	1
79799		600x460			0,15	
79800		600x600			0,175	
79802		1000x600			0,22	
79803		1000x1200			0,295	
79804		2000x1200			0,46	
79805		5000x1200			0,9	
79806		10000x1200			1,6	



1000V | IEC-EN 60243-1





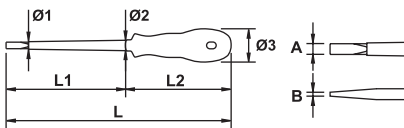

**■ DESTORNILLADORES / SCREWDRIVERS / TOURNEVIS / HANDSCHRAUBER / CACCIAVITI / CHAVES DE FENDA / ОТВЕРТКИ**

El aislamiento de la varilla de los destornilladores 1.000V de EGA Master, ha sido especialmente diseñado para acceder a espacios más reducidos gracias a su aislamiento conico, que le provee de un menor espesor en la punta.

The insulation of EGA Master screwdrivers' bars has been specially designed to allow access to the smallest spaces, as the insulation is made in taper shape (conical), which provides less diameter close to the tip.

L'isolement de la lame des tournevis 1000V d'EGA Master, il a été spécialement conçu pour accéder à des espaces plus réduits grâce à son isolement conique, qui lui octroie une plus petite épaisseur sur la pointe.





**■ MASTERTORK**
**■ ELECTRICISTA / ELECTRICIAN / ELECTRICIEN / ELEKTRIKER / PER ELETRICISTI / ELETTRICISTA / ЭЛЕКТРИЧЕСКАЯ**
**■ MM**

COD.	A (mm)	B (mm)	Ø 1 (mm)	Ø 2 (mm)	Ø 3 (mm)	L (mm)	L1 (mm)	L2 (mm)			
76620	2,5	0,4	4,4	6,1	26	160	75	85	16		
76621	3	0,5	4,4	6,1	26	185	100	85	16		
76622	4	0,8	5,4	7		230	125	105	8		
76623	5,5	1	6,4	8,8	34	255	150	115			
76624	6,5	1,2	8,4	11	36	265	175	130	6		
76625	8	1,6	9,4	12,3	40	305	200	130	6		
76626	10	1,6	11,4	15		330	200	130	6		
76627											

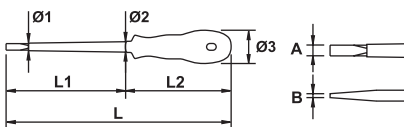

 **1000V** | IEC 60900 | DIN 5265 | Modelo registrado / Registered model / Modèle enregistré

**■ INCH**







COD.	A (inch)	B (inch)	Ø 1 (mm)	Ø 2 (mm)	Ø 3 (mm)	L (mm)	L1 (inch)	L2 (mm)			
75063	3/32	0,016	4,4	6,1	26	160	3	85	16		
75064	1/8	0,02	4,4	6,1	26	185	4	85	16		
75065	5/32	0,032	5,4	7		230	5	105	8		
75066	7/32	0,04	6,4	8,8	34	255	6	115			
75067	1/4	0,046	8,4	11	36	265	7	130	6		
75068	5/16	0,063	9,4	12,3	40	305	8	130	6		
75069	5/16	0,063	9,4	12,3	40	305	7	130	6		
75081	25/64	0,063	11,4	15		330	8	130	6		

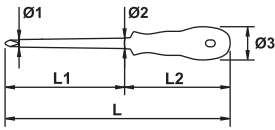

 **1000V** | IEC 60900 | DIN 5265 | Modelo registrado / Registered model / Modèle enregistré

## PHILIPS







COD.		Ø 1 (mm)	Ø 2 (mm)	Ø 3 (mm)	L (mm)	L1 (mm)	L2 (mm)			
76628	PH-0	4,4	5	26	145	60	85	16		
76738	PH-1	6,4	7,6	34	185	80	105	8		
76629					205	100				
76630	PH-2	7,4	9,6	36	240	125	115			
76631	PH-3	9,4	12,3	40	280	150	130	6		-
76632	PH-4				330	200				

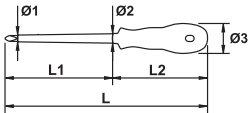

 1000V | IEC 60900 | DIN 5262 | Modelo registrado / Registered model / Modèle enregistré

PLANO-PHILIPS PARA BORNES ELÉCTRICOS / SLOTTED-PHILIPS FOR TERMINAL SCREWS / PHILIPS-À FENTE POUR BORNES ÉLECTRIQUES / SCHLITZ-PHILIPS SCHRAUBENDREHER FÜR SCHRAUBKLEMMEN / TAGLIO-PHILIPS PER TERMINALI ELETTRICI / FENDA-PHILIPS PARA BORNES ELÉCTRICOS / ОТВЕРТКА КРЕСТОВАЯ КЛЕМНАЯ PH









COD.		Ø 1 (mm)	Ø 2 (mm)	Ø 3 (mm)	L (mm)	L1 (mm)	L2 (mm)		
79163		PH-1	6,4	7,6	34	205	100	105	8
79164		PH-2	7,4	9,6	36	240	125	115	6

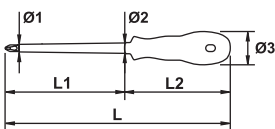

 1000V | IEC 60900 | Modelo registrado / Registered model / Modèle enregistré

## POZIDRIV®\*



COD.		Ø 1 (mm)	Ø 2 (mm)	Ø 3 (mm)	L (mm)	L1 (mm)	L2 (mm)			
76633	PZ-0	4,4	5	26	145	60	85	16		
76634	PZ-1	6,4	7,6	34	205	100	105	8		
76635	PZ-2	7,4	9,6	36	240	125	115			
76636	PZ-3	9,4	12,3	40	280	150	130	6		-
76637	PZ-4				330	200				







 1000V | IEC 60900 | DIN 5262 | Modelo registrado / Registered model / Modèle enregistré

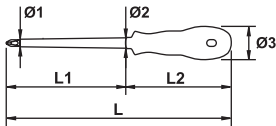

**PLANO-POZIDRIV® PARA BORNES ELÉCTRICOS / SLOTTED-POZIDRIV® FOR TERMINAL SCREWS / POZIDRIV® -À FENTE POUR BORNES ÉLECTRIQUES / SCHLITZ-POZIDRIV® SCHRAUBENDREHER FÜR SCHRAUBKLEMMEN / TAGLIO-POZIDRIV® PER TERMINALI ELETTRICI / FENDA-POZIDRIV® PARA BORNES ELÉCTRICOS / ОТВЕРТКА КРЕТОВАЯ КЛЕМНАЯ POZIDRIV®**









COD.		Ø 1 (mm)	Ø 2 (mm)	Ø 3 (mm)	L (mm)	L1 (mm)	L2 (mm)		
<b>79165</b>		PZ-1	6,4	7,6	34	205	100	105	8
<b>79166</b>		PZ-2	7,4	9,6	36	240	125	115	6

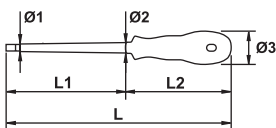

  **1000V** | IEC 60900 | Modelo registrado / Registered model / Modèle enregistré

**TORX®**







COD.		Ø 1 (mm)	Ø 2 (mm)	Ø 3 (mm)	L (mm)	L1 (mm)	L2 (mm)			
<b>76638</b>	T-6		8							
<b>76639</b>	T-7				135	50				
<b>76640</b>	T-8	4,4		26			85			
<b>76641</b>	T-9		5		160			16		
<b>76642</b>	T-10					75				
<b>76643</b>	T-15				180					
<b>76644</b>	T-20	5,8	8							
<b>76645</b>	T-25			34	205	100	105			
<b>76646</b>	T-27	6,4			220	115		8		
<b>76647</b>	T-30	7,4	9,6	36	240	125	115			
<b>76648</b>	T-40	8,7			255					
<b>76649</b>	T-45	9,4	12,3	40	280	150	128	6		
<b>76650</b>	T-50	11,4	15		305	175				

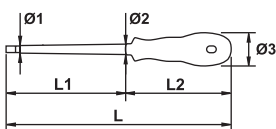

  **1000V** | IEC 60900 | DIN 5262 | Modelo registrado / Registered model / Modèle enregistré



**TAMPER TORX**



COD.		Ø 1 (mm)	Ø 2 (mm)	Ø 3 (mm)	L (mm)	L1 (mm)	L2 (mm)		
<b>75037</b>	TT-6		8						
<b>75038</b>	TT-7				135	50			
<b>75039</b>	TT-8	4,4		26			85	16	
<b>75040</b>	TT-9		5		160				
<b>75041</b>	TT-10					75			
<b>75042</b>	TT-15	5,8	8	34	180		105		



- \*Para tornillos POZIDRIV® (Marca registrada por European Ind. Serv. Ltd.) / \*For screws POZIDRIV® (European Ind. Serv. Ltd. registered trademark) / \*Pour vis POZIDRIV® (Marque enregistrée par European Ind. Serv. Ltd.)
- \*Para tornillos TORX® (Marca registrada por Acument Intellectual Properties, LLC, Troy, Mich., US) / \*For screws TORX® (Acument Intellectual Properties, LLC, Troy, Mich., US registered trademark) / \*Pour vis TORX® (Marque enregistrée par Acument Intellectual Properties, LLC, Troy, Mich., US)



COD.		Ø 1 (mm)	Ø 2 (mm)	Ø 3 (mm)	L (mm)	L1 (mm)	L2 (mm)		
75043	TT-20	5,8	8	34	205	100	105	16	
75044	TT-25	6,4	8	34	220	115	105	8	
75045	TT-27	6,4	9,6	36	240	125	115		•
75046	TT-30	7,4	9,6	36	240	125	115		•
75047	TT-40	8,7	12,3	40	255	150	128	6	
75048	TT-45	9,4	12,3	40	280	150	128	6	
75049	TT-50	11,4	15	40	305	175	130	6	

  1000V | IEC 60900 | Modelo registrado / Registered model / Modèle enregistré

#### ■ DE VASO / SOCKET SCREWDRIVER / CLÉ À DOUILLE EMMANCHÉE / 6-KANT STECKSCHLÜSSEL / BUSSOLE / DE CAIXA / ОТВЕРТКА С ГОЛОВКОЙ

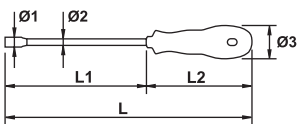
##### ■ MM







COD.		Ø 1 (mm)	Ø 2 (mm)	Ø 3 (mm)	L (mm)	L1 (mm)	L2 (mm)		
74698	4								
74699	5	11	7,5	34	255	150	105	8	
74700	5,5								
74701	6	12,5	8,5	36	275	160	115		
74702	7	12,5	8,5	36	290				
74703	8								
74704	9	16	10,5						•
74705	10							6	
74706	11	19		40	305	175	130		
74707	12	19		40	305	175	130		
74708	13		11,5						
74709	14	21							

  1000V | IEC 60900 | Modelo registrado / Registered model / Modèle enregistré

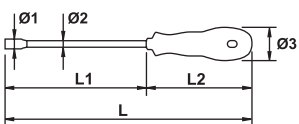

##### ■ INCH









COD.		Ø 1 (mm)	Ø 2 (mm)	Ø 3 (mm)	L (mm)	L1 (inch)	L2 (mm)		
75132	5/32								
74984	3/16	11	7,5	34	255	6	105	8	
75133	7/32								
74985	1/4	12,5	8,5	36	275		115		
74986	5/16								
74987	3/8	16	10,5						•
75136	25/64							6	
74988	7/16	19		40	305	7	130		
75138	15/32	19		40	305	7	130		
74989	1/2	21							

  1000V | IEC 60900 | Modelo registrado / Registered model / Modèle enregistré









## MM

COD.						
74664	9					
74665	10					
74666	11	11	130	115	6	•
74667	12					
74669	14					
74670	17					



## INCH

COD.						
74671	3/16					
74672	1/4					
74673	5/16					
74674	3/8					
74675	7/16	11	5	115	6	•
74676	1/2					
74677	9/16					
74678	5/8					



**DESTORNILLADOR PORTAPUNTAS MAGNÉTICO / MAGNETIC BITHOLDER SCREWDRIVER / TOURNEVIS PORTE-EMBOUS MAGNÉTIQUE / MAGNETISCHER BITHALTER-SCHRAUBENDREHER / CACCIAVITE PORTA INSERTI MAGNETICOM / CHAVE PORTA PONTAS MAGNETICO / ОТВЕРТКА С МАГНИТНЫМ БИТОДЕРЖАТЕЛЕМ**



COD.		L (mm)			
76737	1/4	210	120	6	•

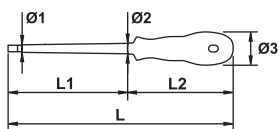

## HEXAGONAL ALLEN

## MM



COD.		Ø 1 (mm)	Ø 2 (mm)	Ø 3 (mm)	L (mm)	L1 (mm)	L2 (mm)		
74710	2,5								
74711	3	4,4	6	26	160	75	85	16	
74712	4	5,8	8		185	100		8	•
74713	5	6,4		34	205		105		
74714	6	7,8	11,2		230	125		6	
74715	8	9,8	13,4	40	280	150	130		-



### INCH

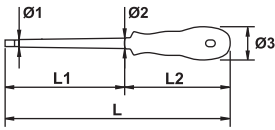

COD.		Ø 1 (mm)	Ø 2 (mm)	Ø 3 (mm)	L (mm)	L1 (inch)	L2 (mm)		
75083	1/8	4,4	6	26	160	3	85	16	
75084	5/32	5,8	8	34	185	4	105	8	•
75131	13/64	6,4	13,4	40	205	6	130	6	-
75097	5/16	9,8	13,4	40	280	6	130	6	-



1000V | ICE 60900 | Modelo registrado / Registered model / Modèle enregistré

### ROTORK

### ELECTRICISTA / ELECTRICIAN / ELECTRICIEN / ELEKTRIKER / PER ELETTICISTI / ELETRICISTA / ЭЛЕКТРИЧЕСКАЯ

### MM

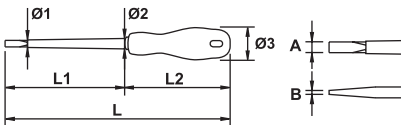

COD.	A (mm)	B (mm)	Ø 1 (mm)	Ø 2 (mm)	Ø 3 (mm)	L (mm)	L1 (mm)	L2 (mm)			
76730	2,5	0,4	4,4	6,1	22	135	60	75	16		•
76731	3	0,5	4,4	6,1	22	135	60	75	16		•
76651	4	0,8	5,4	7	31	230	125	105	8		•
76652	4	0,8	5,4	7	31	230	125	105	8		•
76653	5,5	1	6,4	8,8	31	255	150	105	8		•
76654	6,5	1,2	7,8	11	35	290	175	115	6		-
76732	8	1,2	9,4	12,3	35	290	175	115	6		-
76733	10	1,6	11,4	15	35	315	200	115	6		-



1000V | IEC 60900 | DIN 5265

### INCH

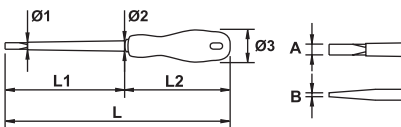







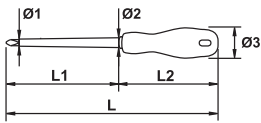

COD.	A (inch)	B (inch)	Ø 1 (mm)	Ø 2 (mm)	Ø 3 (mm)	L (mm)	L1 (inch)	L2 (mm)		
75172	3/32	0,016	4,4	6,1	22	135	2	75	16	
75173	1/8	0,02	4,4	6,1	22	135	2	75	16	
75174	1/8	0,02	4,4	6,1	22	175	4	75	16	
75175	5/32	0,032	5,4	7	31	230	5	105	8	•
75176	3/16	0,04	6,4	8,8	31	255	6	105	8	•
75177	1/4	0,046	7,8	11	35	290	7	115	6	
75178	5/16	0,046	9,4	12,3	35	290	7	115	6	
75179	25/64	0,063	11,4	15	35	315	8	115	6	



1000V | IEC 60900 | DIN 5265

## PHILIPS









COD.		Ø 1 (mm)	Ø 2 (mm)	Ø 3 (mm)	L (mm)	L1 (mm)	L2 (mm)			
76655	PH-0	4,4	5	22	135	60	75	16		
76656	 PH-1	6,4	8	31	205	100	105	8		
76657	PH-2	7,4	9,6		230	125				
76658	PH-3	9,4	12,3	35	268	150	118	6		-
76735	-	PH-4	9,4	12,3	35	318	200	118	6	

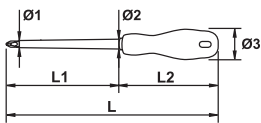

  1000V | IEC 60900 | DIN 5262

## POZIDRIV®\*



COD.		Ø 1 (mm)	Ø 2 (mm)	Ø 3 (mm)	L (mm)	L1 (mm)	L2 (mm)		
76659	-	PZ-0	4,4	5	22	135	60	75	16
76660	 PZ-1	6,4	8	31	205	100	105	8	
76661	PZ-2	7,4	9,6		230	125			
76662	PZ-3	9,4	12,3	35	268	150	118	6	
76736	-	PZ-4	9,4	12,5	35	318	200	118	6





  1000V | IEC 60900 | DIN 5262

## MICROTRONIC

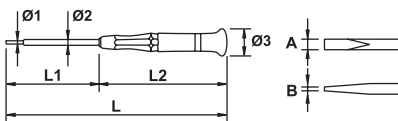
## ELECTRICISTA / ELECTRICIAN / ELECTRICIEN / ELEKTRIKER / PER ELETRICISTI / ELETTRICISTA / ЭЛЕКТРИЧЕСКАЯ







COD.	A (mm)	B (mm)	Ø 1 (mm)	Ø 2 (mm)	Ø 3 (mm)	L (mm)	L1 (mm)	L2 (mm)		
75156	1,5	0,23	1,5	3,1		140	40			
75157	1,8	0,3	1,8	3,4		160	60	100	10	
75158	2	0,4	2	3,6	19					
75159	2,5		2,5	4,1		175	75			
75201	3	0,5	3	4,6						

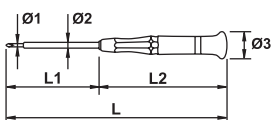

 1000V | IEC 60900 | DIN 7437

## PHILIPS



COD.		Ø 1 (mm)	Ø 2 (mm)	Ø 3 (mm)	L (mm)	L1 (mm)	L2 (mm)		
75202	PH-00	2,5	4,1	19	175	75	100	10	
75203	PH-0	3	4,6						



  1000V | IEC 60900 | DIN 7438

\*Para tornillos POZIDRIV® (Marca registrada por European Ind. Serv. Ltd.) / \*For screws POZIDRIV® (European Ind. Serv. Ltd. registered trademark) / \*Pour vis POZIDRIV® (Marque enregistrée par European Ind. Serv. Ltd.)

**EXPOSITORES Y SETS / DISPLAYS AND SETS / PRENTOIRS ET SETS / STÄNDER / ESPOSITORE / DISPLAY STAND / СТЕНДЫ**
**MASTERTORK**
**4 PCS.**

COD.	PCS.
<b>74691</b>	4

PCS./UN.	COD. PCS.	
1	74665	10 mm
	74667	12 mm
	74669	14 mm
	74670	17 mm



COD.	PCS.	
<b>76675</b>	4	A
<b>76676</b>		B
<b>76677</b>		C

PCS./UN.	COD. PCS.	
1	76628	PH0
	76629	PH1
	76630	PH2
	76631	PH3

COD.	PCS.	
<b>76663</b>	4	A
<b>76664</b>		B
<b>76665</b>		C

PCS./UN.	COD. PCS.	
1	76633	PZ0
	76634	PZ1
	76635	PZ2
	76636	PZ3

**5 PCS.**

COD.	PCS.	
<b>76666</b>	5	A
<b>76667</b>		B
<b>76668</b>		C

PCS./UN.	COD. PCS.	
1	76621	3 x 100 mm
	76622	4 x 125 mm
	76624	5,5 x 150 mm
	76625	6,5 x 150 mm
	76626	8 x 175 mm

COD.	PCS.	
<b>76909</b>	5	A
<b>76910</b>		B
<b>76911</b>		C

PCS./UN.	COD. PCS.	
1	76621	3 x 100 mm
	76622	4 x 125 mm
	76624	5,5 x 150 mm
	76634	PZ1
	76635	PZ2

COD.	PCS.	
<b>76916</b>	5	B
<b>76917</b>		C

PCS./UN.	COD. PCS.	
1	76628	PH0
	76629	PH1
	76630	PH2
	76631	PH3
	76632	PH4

**6 PCS.**





COD.	PCS.	
<b>76669</b>	6	A
<b>76670</b>		B
<b>76671</b>		C

PCS./UN.	COD. PCS.	
1	76620	2,5 x 75 mm
	76621	3 x 100 mm
	76622	4 x 125 mm
	76624	5,5 x 150 mm
	76625	6,5 x 150 mm
	76626	8 x 175 mm





COD.	PCS.	
<b>76900</b>	6	A
<b>76901</b>		B
<b>76902</b>		C

PCS./UN.	COD. PCS.	
1	76621	3 x 100 mm
	76622	4 x 125 mm
	76624	5,5 x 150 mm
	76628	PH0
	76629	PH1
	76630	PH2





COD.	PCS.	
<b>76921</b>		A
<b>76922</b>	6	B
<b>76923</b>		C

PCS./UN.	COD. PCS.		
1	76620	2,5 x 75 mm	
	76621	3 x 100 mm	
	76622	4 x 125 mm	
	76623	5,5 x 125 mm	
	76629	PH1	
	76630	PH2	

COD.	PCS.	
<b>76927</b>		A
<b>76928</b>	6	B
<b>76929</b>		C

PCS./UN.	COD. PCS.		
1	76621	3 x 100 mm	
	76622	4 x 125 mm	
	76625	6,5 x 150 mm	
	76629	PH1	
	76630	PH2	
	76631	PH3	

COD.	PCS.	
<b>76933</b>		A
<b>76934</b>	6	B
<b>76935</b>		C

PCS./UN.	COD. PCS.		
1	76621	3 x 100 mm	
	76622	4 x 125 mm	
	76625	6,5 x 150 mm	
	76633	PZ0	
	76634	PZ1	
	76635	PZ2	

COD.	PCS.	
<b>76930</b>		A
<b>76931</b>	6	B
<b>76932</b>		C

PCS./UN.	COD. PCS.	
1	76640	T8
	76641	T9
	76642	T10
	76643	T15
	76644	T20
	76645	T25

COD.	PCS.	
<b>76926</b>	6	C

PCS./UN.	COD. PCS.	
1	74701	6 mm
	74702	7 mm
	74703	8 mm
	74704	9 mm
	74705	10 mm
	74708	13 mm







## 7 PCS.

COD.	PCS.	
<b>76938</b>	7	C







PCS./UN.	COD. PCS.	
1	74699	5 mm
	74700	5,5 mm
	74701	6 mm
	74702	7 mm
	74703	8 mm
	74705	10 mm
74708	13 mm	

## 8 PCS.

COD.	PCS.	
<b>76672</b>		A
<b>76673</b>	8	B
<b>76674</b>		C

PCS./UN.	COD. PCS.		
1	76621	3 x 100 mm	
	76622	4 x 125 mm	
	76624	5,5 x 150 mm	
	76625	6,5 x 150 mm	
	76629	PH1	
	76630	PH2	
	76634	PZ1	
	76635	PZ2	

COD.	PCS.	
<b>76918</b>		A
<b>76919</b>	8	B
<b>76920</b>		C

PCS./UN.	COD. PCS.		
1	76628	2,5 x 75 mm	
	76629	4 x 125 mm	
	76630	5,5 x 125 mm	
	76631	6,5 x 150 mm	
	76620	PH0	
	76622	PH1	
	76623	PH2	
	76625	PH3	



COD.	PCS.	
<b>76939</b>		A
<b>76940</b>	8	B
<b>76941</b>		C

PCS./UN.	COD. PCS.		
1	76620	2,5 x 75 mm	⊖
	76621	3 x 100 mm	
	76622	4 x 125 mm	
	76625	6,5 x 150 mm	
	76628	PH0	⊕
	76629	PH1	
	76630	PH2	
	76631	PH3	

COD.	PCS.	
<b>76906</b>		A
<b>76907</b>	8	B
<b>76908</b>		C

PCS./UN.	COD. PCS.		
1	76620	2,5 x 75 mm	⊖
	76621	3 x 100 mm	
	76622	4 x 125 mm	
	76624	5,5 x 150 mm	
	76625	6,5 x 150 mm	⊕
	76633	PZ0	
	76634	PZ1	
	76635	PZ2	

COD.	PCS.	
<b>76903</b>		A
<b>76904</b>	8	B
<b>76905</b>		C

PCS./UN.	COD. PCS.		
1	76621	3 x 100 mm	⊖
	76622	4 x 125 mm	
	76624	5,5 x 150 mm	
	76625	6,5 x 150 mm	
	76629	PH1	⊕
	76630	PH2	
	76634	PZ1	
	76635	PZ2	

COD.	PCS.	
<b>76912</b>		A
<b>76913</b>	8	B
<b>76914</b>		C

PCS./UN.	COD. PCS.		
1	76628	PH0	
	76629	PH1	⊕
	76630	PH2	
	76631	PH3	
	76633	PZ0	⊕
	76634	PZ1	
	76635	PZ2	
	76636	PZ3	

10 PCS.



COD.	PCS.	
<b>79468</b>	10	D

PCS./UN.	COD. PCS.		
1	75132	5/32"	
	74984	3/16"	
	75133	7/32"	
	74985	1/4"	
	74986	5/16"	⊖
	74987	3/8"	
	75136	25/64"	
	74988	7/16"	
	75138	15/32"	
	74989	1/2"	

12 PCS.

COD.	PCS.	
<b>79466</b>	12	D

PCS./UN.	COD. PCS.		
1	75038	TT7	
	75039	TT8	
	75040	TT9	
	75041	TT10	
	75042	TT15	
	75043	TT20	⊕
	75044	TT25	
	75045	TT27	
	75046	TT30	
	75047	TT40	
	75048	TT45	
	75049	TT50	



COD.	PCS.	
<b>79467</b>	12	D

PCS./UN.	COD. PCS.	
1	74698	4 mm
	74699	5 mm
	74700	5,5 mm
	74701	6 mm
	74702	7 mm
	74703	8 mm
	74704	9 mm
	74705	10 mm
	74706	11 mm
	74707	12 mm
	74708	13 mm
	74709	14 mm

PCS./UN.	COD. PCS.	Descripción / Description / Description	
1	76607	Alicate universal Mastercut Titacrom® Bimat / Mastercut Titacrom® Bimat combination plier	180 mm
	76621	Destornillador electricista Mastertork / Electrician Mastertork screwdriver	3 x 100 mm
	76629	Destornillador Philips Mastertork / Philips Mastertork screwdriver	PH-1, 5 x 100 mm
	62493	Alicate para terminales aislados / For insulated terminals plier	200 mm
	66074	Buscapolos digital / Digital voltage tester	160 mm

COD.	PCS.	Dimensiones / Dimensions / Dimensions	Kg
<b>76679</b>	4	320 x 190 x 280	0,70

⚡ 1000V | IEC 60900

PCS./UN.	COD. PCS.	Descripción / Description / Description	
1	76607	Alicate universal Mastercut Titacrom® Bimat / Mastercut Titacrom® Bimat combination plier	180 mm
	76621	Destornillador electricista Mastertork / Electrician Mastertork screwdriver	3 x 100 mm
	76622	Destornillador Philips Mastertork / Philips Mastertork screwdriver	PH-1, 5 x 100 mm

### 13 PCS.

COD.	PCS.	
<b>79465</b>	13	D

PCS./UN.	COD. PCS.	
1	76638	T6
	76639	T7
	76640	T8
	76641	T9
	76642	T10
	76643	T15
	76644	T20
	76645	T25
	76646	T27
	76647	T30
	76648	T40
	76649	T45
	76650	T50

### ROTORK

#### 4 PCS.

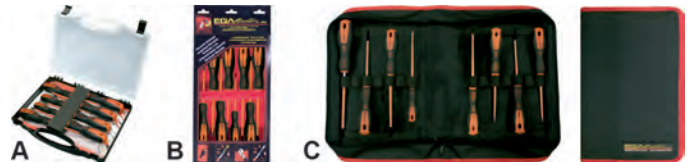

COD.	PCS.	
<b>76987</b>		A
<b>76988</b>	4	B
<b>76989</b>		C

PCS./UN.	COD. PCS.	
1	76655	PH0
	76656	PH1
	76657	PH2
	76658	PH3

COD.	PCS.	
<b>76984</b>		A
<b>76985</b>	4	B
<b>76986</b>		C

PCS./UN.	COD. PCS.	
1	76659	PZ0
	76660	PZ1
	76661	PZ2
	76662	PZ3

#### 5 PCS.

COD.	PCS.	
<b>76961</b>	5	B
<b>76962</b>		C

PCS./UN.	COD. PCS.	
1	76655	PH0
	76656	PH1
	76657	PH2
	76658	PH3
	76735	PH4



COD.	PCS.	Dimensiones / Dimensions / Dimensions	Kg
<b>76678</b>	5	320 x 190 x 280	0,78

⚡ 1000V | IEC 60900

### 6 PCS.



COD.	PCS.	
<b>76680</b>		A
<b>76681</b>	6	B
<b>76682</b>		C

PCS./UN.	COD.	PCS.		
1	76651	3 x 100 mm	⊖	☐
	76652	4 x 125 mm		
	76653	5,5 x 150 mm		
	76655	PH0	⊕	-
	76656	PH1		
	76657	PH2		

COD.	PCS.	
<b>76972</b>		A
<b>76973</b>	6	B
<b>76974</b>		C

PCS./UN.	COD.	PCS.		
1	76730	2,5 x 60 mm	⊖	☐
	76651	3 x 100 mm		
	76652	4 x 125 mm		
	76653	5,5 x 150 mm	⊕	-
	76654	6,5 x 150 mm		
	76732	8 x 175 mm		

COD.	PCS.	
<b>76954</b>		A
<b>76955</b>	6	B
<b>76956</b>		C

PCS./UN.	COD.	PCS.		
1	76651	3 x 100 mm	⊖	☐
	76652	4 x 125 mm		
	76653	5,5 x 150 mm		
	76654	6,5 x 150 mm	⊕	-
	76732	8 x 175 mm		
	76733	10 x 200 mm		

COD.	PCS.	
<b>76966</b>		A
<b>76967</b>	6	B
<b>76968</b>		C

PCS./UN.	COD.	PCS.		
1	76730	2,5 x 60 mm	⊖	☐
	76651	3 x 100 mm		
	76652	4 x 125 mm		
	76653	5,5 x 150 mm	⊕	-
	76656	PH1		
	76657	PH2		

COD.	PCS.	
<b>76942</b>		A
<b>76943</b>	6	B
<b>76944</b>		C

PCS./UN.	COD.	PCS.		
1	76651	3 x 100 mm	⊖	☐
	76652	4 x 125 mm		
	76653	5,5 x 150 mm		
	76655	PH0	⊕	-
	76656	PH1		
	76657	PH2		

COD.	PCS.	
<b>76951</b>		A
<b>76952</b>	6	B
<b>76953</b>		C

PCS./UN.	COD.	PCS.		
1	76651	3 x 100 mm	⊖	☐
	76652	4 x 125 mm		
	76653	5,5 x 150 mm		
	76659	PZ0	⊕	-
	76660	PZ1		
	76661	PZ2		

COD.	PCS.	
<b>76975</b>		A
<b>76976</b>	6	B
<b>76977</b>		C







PCS./UN.	COD.	PCS.		
1	76651	3 x 100 mm	⊖	☐
	76652	4 x 125 mm		
	76654	6,5 x 150 mm		
	76656	PH1	⊕	-
	76657	PH2		
	76658	PH3		

COD.	PCS.	
<b>76969</b>		A
<b>76970</b>	6	B
<b>76971</b>		C







PCS./UN.	COD.	PCS.		
1	76651	3 x 100 mm	⊖	☐
	76652	4 x 125 mm		
	76654	6,5 x 150 mm		
	76659	PZ0	⊕	-
	76660	PZ1		
	76661	PZ2		

## 8 PCS.







COD.	PCS.	
<b>76683</b>		A
<b>76684</b>	8	B
<b>76685</b>		C

PCS./UN.	COD. PCS.		
1	76651	3 x 100 mm	
	76652	4 x 125 mm	
	76653	5,5 x 150 mm	
	76654	6,5 x 150 mm	
	76656	PH1	
	76657	PH2	
	76660	PZ1	
76661	PZ2		



COD.	PCS.	
<b>76963</b>		A
<b>76964</b>	8	B
<b>76965</b>		C





PCS./UN.	COD. PCS.		
1	76730	2,5 x 60 mm	
	76652	4 x 125 mm	
	76653	5,5 x 150 mm	
	76654	6,5 x 150 mm	
	76655	PH0	
	76656	PH1	
	76657	PH2	
	76658	PH3	

COD.	PCS.	
<b>76981</b>		A
<b>76982</b>	8	B
<b>76983</b>		C







PCS./UN.	COD. PCS.		
1	76730	2,5 x 60 mm	
	76651	3 x 100 mm	
	76652	4 x 125 mm	
	76654	6,5 x 150 mm	
	76655	PH0	
	76656	PH1	
	76657	PH2	
	76658	PH3	

COD.	PCS.	
<b>76948</b>		A
<b>76949</b>	8	B
<b>76950</b>		C







PCS./UN.	COD. PCS.		
1	76730	2,5 x 60 mm	
	76731	3 x 60 mm	

PCS./UN.	COD. PCS.		
1	76652	4 x 125 mm	
	76653	5,5 x 150 mm	
	76654	6,5 x 150 mm	
	76659	PZ0	
	76660	PZ1	
	76661	PZ2	

COD.	PCS.	
<b>76978</b>		A
<b>76979</b>	8	B
<b>76980</b>		C

PCS./UN.	COD. PCS.		
1	76651	3 x 100 mm	
	76652	4 x 125 mm	
	76653	5,5 x 150 mm	
	76654	6,5 x 150 mm	
	76655	PH0	
	76656	PH1	
	76657	PH2	
	76658	PH3	

COD.	PCS.	
<b>76957</b>		A
<b>76958</b>	8	B
<b>76959</b>		C





PCS./UN.	COD. PCS.		
1	76655	PH0	
	76656	PH1	
	76657	PH2	
	76658	PH3	
	76659	PZ0	
	76660	PZ1	
	76661	PZ2	
	76662	PZ3	

## MICROTRONIC

## 7 PCS.



COD.	PCS.
<b>76083</b>	7

PCS./UN.	COD. PCS.		
1	75156	1,5 x 40 mm	
	75157	1,8 x 60 mm	
	75158	2 x 60 mm	
	75159	2,5 x 75 mm	
	75201	3 x 75 mm	
	75202	PH00	
	75203	PH0	

**JUEGOS ELECTRICIDAD / ELECTRICIAN SETS / SETS ÉLECTRICIENS / WERKZEUGSÄTZE FÜR ELEKTRIZITÄT / KIT ELETTRICISTI / JOGOS ÉTRICIDADE / НАБОР ЭЛЕКТРИКА**

5 PCS.



COD.	PCS.		Medidas en / Sizes in / Mesures en	
<b>79060</b>	5	51033	mm	1,2

PCS./UN.	Composición / Composition / Composition	Descripción / Description / Description	
4	76583, 76594, 76603, 76595	Alicates / Pliers	1000V
1	73004	Tenaza de canal / Box joint	

10 PCS.



COD.	PCS.		Medidas en / Sizes in / Mesures en	
<b>79061</b>	10	51033	mm	3

PCS./UN.	Composición / Composition / Composition	Descripción / Description / Description	
4	76583, 76594, 76603, 76595	Alicates / Pliers	1000V
3	76621, 76623, 76626	Destornilladores electricistas / Electrician screwdrivers	
2	76634, 76635	Destornilladores Pozidriv® / Pozidriv® screwdrivers	
1	73004	Tenaza de canal / Box joint	



COD.	PCS.		Medidas en / Sizes in / Mesures en	
<b>79062</b>	10	51033	mm	2,5

PCS./UN.	Composición / Composition / Composition	Descripción / Description / Description	
4	76583, 76603, 76590, 76599	Alicates / Pliers	1000V
1	66072	Tester	
4	76621, 76622, 76623, 76625	Destornilladores electricistas / Electrician screwdrivers	1000V
1	76629	Destornilladores Philips / Philips screwdriver	

17 PCS.



COD.	PCS.		Medidas en / Sizes in / Mesures en	
<b>79063</b>	17	51033	mm	3,6

PCS./UN.	Composición / Composition / Composition	Descripción / Description / Description	
6	76584, 76599, 76592, 76603, 76589, 76590	Alicates / Pliers	1000V
1	66072	Tester	
6	76620, 76621, 76623, 76625, 76626, 76627	Destornilladores electricistas / Electrician screwdrivers	1000V
2	76629, 76630	Destornilladores Philips / Philips screwdriver	
	73035, 73036	Cuchillos / Knives	

26 PCS.



COD.	PCS.		Medidas en / Sizes in / Mesures en	
<b>79064</b>	26	51033	mm	5

PCS./UN.	Composición / Composition / Composition	Descripción / Description / Description	
7	76583, 76603, 76592, 76594, 76595, 76590, 76589	Alicates / Pliers	1000V
2	73156, 73158	Llaves hexagonales / Hexagonal keys	
5	76621, 76622, 76623, 76625, 76626	Destornilladores electricistas / Electrician screwdrivers	
2	76629, 76630	Destornilladores Philips / Philips screwdriver	
2	76634, 76635	Destornilladores Pozidriv® / Pozidriv® screwdrivers	1000V
4	74700, 74701, 74702, 74703	Destornilladores de vaso / Socket screwdriver	
2	73035, 73036	Cuchillos / Knives	
1	73008	Cortacables / Cable cutters	
	66072	Tester	-

## 27 PCS.



COD.	PCS.		Medidas en / Sizes in / Mesures en	
<b>79065</b>	27	51054	inch	8

PCS./UN.	Composición / Composition / Composition	Descripción / Description / Description	
3	76583, 76597, 76592	Alicates / Pliers	1000V
	76621, 76623, 76625	Destornilladores electricistas / Electrician screwdrivers	
2	76629, 76630	Destornilladores Philips / Philips screwdriver	
1	73685	Carraca / Ratchet	-
2	73280, 73281	Alargadera / Extension	
8	75162, 75163, 75164, 75165, 75167, 75168, 75169, 75170	Vasos / Sockets	3/8" - 1000V
	73349, 73350, 73351, 73352, 73353, 73354, 73355, 73356	Llaves de estrella acodada una boca / Offset ring wrenches	1000V



## 37 PCS.



COD.	PCS.		Medidas en / Sizes in / Mesures en	
<b>79066</b>	37	51054	mm	9

PCS./UN.	Composición / Composition / Composition	Descripción / Description / Description	
4	76583, 76603, 76592, 76599	Alicates / Pliers	1000V
1	73008	Cortacables / Cable cutters	
6	73064, 73067, 73068, 73071, 73073, 73076	Llaves fijas una boca / Single ended open jaw spanner	
	73122, 73125, 73126, 73129, 73131, 73134	Llaves de estrella / Ring wrenches	
1	73683	Carraca / Ratchet	
2	73446, 73445	Alargadera / Extension	
1	73448	Mango en T / T Handle	1000V
9	74962, 74963, 74964, 74965, 74966, 74969, 74971, 74974, 74976	Vasos / Sockets	1/2" - 1000V
2	73035, 73036	Cuchillos / Knives	
1	73040	Pinza de plástico / Plastic tweezers	1000V
4	76621, 76622, 76623, 76625	Destornilladores electricistas / Electrician screwdrivers	



COD.	PCS.		Medidas en / Sizes in / Mesures en	
<b>76688</b>	37	-	mm	3,0
<b>76689</b>		51010		7,0

PCS./UN.	Composición / Composition / Composition	Descripción / Description / Description	
5	76584, 76591, 76593, 76595, 76603	Alicates / Pliers	1000V
	73008	Tenaza cortacables / Cable cutters	
1	73040	Pinzas / Tweezers	
	73035	Cuchillos / Knives	
	73005	Tenazas de canal / Box joint pincers	
5	73064, 73065, 73067, 73068, 73070	Llaves fijas una boca / Single ended open jaw spanner	
1	69534	Tijera electricista / Electrician's scissors	-
	51257	Tester	
5	76621, 76622, 76624, 76625, 76626	Destornilladores electricistas / Electrician screwdrivers	1000V
3	76629, 76630, 76631	Destornilladores Philips / Philips screwdriver	
	63254	Soldador de estaño / Tin soldering iron	
1	63256	Succionador con boquilla antiestática para soldadura / Desoldering pump with anti-static rubber nozzle	-
6	73232, 73233, 73234, 73236, 73238, 73239	Vasos / Sockets	
	73245	Alargadera / Extension	1000V
1	73246	Carraca / Ratchet	

### 52 PCS.



COD.	PCS.		Medidas en / Sizes in / Mesures en	
<b>76686</b>		-	mm	6,0
<b>76687</b>	52	51011	mm	31

PCS./UN.	Composición / Composition / Composition	Descripción / Description / Description	
8	76584, 76590, 76592, 76591, 76593, 76594, 76595, 76603	Alicates / Pliers	
1	73008	Tenaza cortacables / Cable cutters	
2	73040, 73041	Pinzas / Tweezers	
	73035, 73036	Cuchillos / Knives	
	73011	Cortacables de carraca / Ratchet electrician cable cutter	1000V
1	73005	Tenazas de canal / Box joint pincers	
	76552	Llave ajustable / Adjustable wrench	
8	73064, 73065, 73066, 73067, 73068, 73071, 73073, 73076	Llaves fijas una boca / Single ended open jaw spanner	
	69534	Tijera electricista / Electrician's scissors	
1	62494	Alicate para terminales / Terminals plier	-
	51257	Tester	
6	76621, 76622, 76624, 76625, 76626, 76627	Destornilladores electricistas / Electrician screwdrivers	
5	76628, 76629, 76630, 76631, 76632	Destornilladores Philips / Philips screwdriver	1000V
	63254	Soldador de estaño / Tin soldering iron	
1	63256	Succionador con boquilla antiestática para soldadura / Desoldering pump with anti-static rubber nozzle	-
	65587	Espejo articulado / Joint telescopic mirror	
6	73232, 73233, 73234, 73236, 73238, 73239	Vasos / Sockets	
1	73245	Alargadera / Extension	1000V
	73687	Carraca / Ratchet	
3	73251, 73252, 73253	Boquillas hexagonales / Hexagonal sockets	

### 16 PCS.



COD.	PCS.		Medidas en / Sizes in / Mesures en	
<b>76690</b>		-	mm	2,0
<b>76691</b>	16	51013	mm	4,0

PCS./UN.	Composición / Composition / Composition	Descripción / Description / Description	
3	76584, 76591, 76595	Alicates / Pliers	
	73040	Pinzas / Tweezers	
1	73035	Cuchillos / Knives	1000V
3	73064, 73067, 73070	Llaves fijas una boca / Single ended open jaw spanner	
1	69534	Tijera electricista / Electrician's scissors	
	66071	Buscapolos / Voltage tester	-
4	76621, 76622, 76625, 76626	Destornilladores electricistas / Electrician screwdrivers	
2	76629, 76630	Destornilladores Philips / Philips screwdriver	1000V

**SET DE MANTENIMIENTO DE COCHE ELÉCTRICO / ELECTRIC VEHICLE MAINTENANCE SET / SET DE MAINTENANCE POUR VOITURE ÉLECTRIQUE / WARTUNGSSATZ FÜR ELEKTROFAHRZEUGE / SET DI MANUTENZIONE VEICOLO ELETTRICO / JOGO DE MANUTENÇÃO PARA CARRO ELÉCTRICO / НАБОР ДЛЯ ОБСЛУЖИВАНИЯ АВТОМОБИЛЬНЫХ ЭЛЕКТРОДВИГАТЕЛЕЙ**

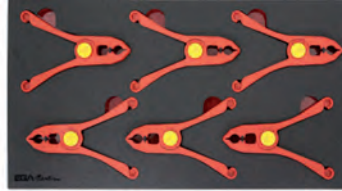

COD.	PCS.		Medidas en / Sizes in / Mesures en		
<b>79086</b>	55	58597	mm	●	21

PCS./UN.	Composición / Composition / Composition	Descripción / Description / Description
4	79799	Mantas aislantes / Insulating blankets
6	73249	Grapas / Insulating clamps
1	73281	Alargadera 3/8" / Extension 3/8"
	75204	Alargadera 1/4" / Extension 1/4"
7	73285	Adaptador / Adapter
	73233,73234,73235,73236,73237,73238,73239	Llaves de vaso 1/4" / 1/4" Socket wrenches
	74918,74919,74920,74921,74922,74923	Llaves de vaso 3/8" / 3/8" Socket wrenches
3	79495,79496,79497	Punta con cuadrado guía 1/4" / 1/4" Socket bit
	73251,73252,73253	Boquilla hexagonal 1/4" / 1/4" Hexagonal socket
1	76593	Alicate telefonista boca curva / Bent nose plier
	76595	Alicate corte diagonal / Diagonal cutting plier
	75034	Llave dinamométrica 3/8" / 3/8" Torque wrench
	73004	Tenaza de canal 10" / 10" Box joint pincer
1	73008	Tenaza cortacables / Cable cutters
	73685	Carraca 3/8" / 3/8" Ratchet
3	74712,74713,74714	Destornillador punta hexagonal allen / Hexagonal Allen screwdrivers
1	76657	Destornillador philips / Philips screwdriver
3	76626,76623,76621	Destornillador electricista / Electrician screwdrivers
	75046,75044,75043	Destornillador Tamper torx / Tamper torx screwdrivers
6	73288,73289,73287	Boquillas de autofijación / Self clamping slip-on claps
1	51251	Multímetro / Multimeter



## **SUKHOI Civil Aircraft (Russia)**

*Savchenko O.S.*  
Deputy Director of the Technical Department

"Following the results of the tests carried out at the SCAC (Sukhoi Civil Aircraft Company) in Komsomolsk-en-Amur during 2017, it was decided to recommend the EGA Master branded products."



**ESD**

ESD ANTIESTÁTICA  
ESD ANTISTATIC  
ESD ANTISTATIQUE  
ESD ANTISTATISCH  
ESD ANTISTATICA  
ESD ANTI-ESTÁTICA

АНТИСТАТИЧЕСКИЙ ИНСТРУМЕНТ ESD

2



ESD



La descarga eléctrica (Electro Static Discharge, ESD en inglés) es un fenómeno electrostático que hace que circule una corriente eléctrica repentina y momentáneamente entre dos objetos de distinto potencial eléctrico.

Los productos ESD de EGA Master hacen que se derive la energía electrostática de una forma controlada y segura tanto para el usuario como para los componentes electrónicos, lo que los convierte en el aliado ideal de la electrónica.

Los mangos bimateriales están especialmente diseñados con forma ergonómica, de tacto suave y antideslizante, favoreciendo el buen trabajo de la herramienta.

#### Aviso de seguridad:

No hay que confundir la herramienta ESD con herramienta aislante, por lo que no se deben utilizar nuestros productos ESD en componentes sometidos a tensión eléctrica.

*The Electro Static Discharge, ESD, is an electrostatic phenomenon which makes a sudden and momentary electrical current flow between two different objects with different electrical potential.*

*EGA Master ESD products dispose of the electrostatic energy in a safe and controlled way for the user and electronic components. That makes them the perfect tools for electronic applications.*

*Bimaterial antislippery and ergonomic handles with a soft feel for the best performance.*

#### Safety advice:

*Do not confuse ESD tools with insulated ones. ESD tools should not be used with components subject to electrical voltage.*

La décharge électrostatique (Electro Static Discharge, ESD en anglais) est un phénomène électrostatique qui fait circuler un courant électrique soudain et momentané entre deux objets de potentiel électrique différent.

Les produits ESD EGA Master font que l'énergie électrostatique soit déviée d'une façon contrôlée et sûre, aussi bien pour l'utilisateur que pour les composants électroniques, ce qui les rend des bons amis de l'électronique.

Les manches Bi-matière sont spécialement conçus avec une forme ergonomique, de toucher doux et anti-dérapant, favorisant un bon usage de l'outil.

#### Avis de sécurité:

Il ne faut pas confondre un outil ESD avec un outil isolé, car il ne faut pas utiliser nos produits ESD avec des composants soumis à la tension électrique.

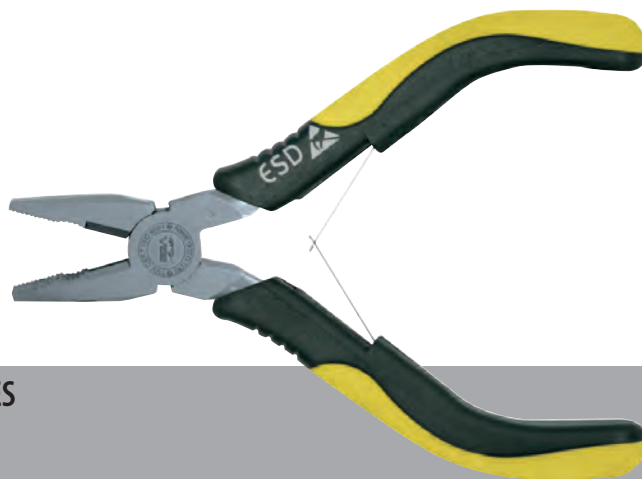

### ALICATES PLIERS PINCES

Los alicates mini ESD EGA Master están fabricados en acero al Cr-V de alta calidad, que proporciona excelentes propiedades mecánicas y una alta precisión en los filos de corte. Los mangos bimateriales aseguran la disipación de la carga estática de manera segura y controlada, además de proporcionar un buen agarre ergonómico.

*EGA Master mini ESD pliers are made in high-quality Cr-V steel, which provides excellent mechanical properties and high accuracy in the cutting edges. The bimaterial handles ensure the vanishing of static charge in a safe and controlled way as well as comfortable ergonomic grip.*

Les MINI pinces ESD EGA Master sont fabriquées en acier Cr-V de haute qualité, qui confère d'excellentes propriétés mécaniques et une haute précision du fil de coupe. Les manches Bimat assurent la dissipation de la charge statique de manière sûre et contrôlée, et confèrent une bonne prise ergonomique.

### DESTORNILLADORES SCREWDRIVERS TOURNEVIS



Los destornilladores mini ESD EGA Master garantizan un trabajo seguro y cómodo, gracias a su mango disipador de carga electrostática, ergonómico, suave y cómodo para el uso. Las varillas están fabricadas en acero al Cr-V de alta calidad. Las puntas ofrecen un mecanizado de alta precisión y gran durabilidad, con un acabado cromado mate.

*EGA Master mini ESD screwdrivers guarantee a safe and comfortable work. Electrostatic discharge is facilitated due to their ergonomic and smooth dissipative handles. The blades are made in high-quality Cr-V steel. The tips are machined with high accuracy. The very durable blades are matt chromed.*

Les tournevis Mini ESD d'EGA Master garantissent un travail sûr et commode, grâce à leur manche ergonomique, doux et commode d'usage, éliminateur de charge électrostatique. Les lames sont fabriquées en acier Cr-V de haute qualité. Les pointes sont fraisées avec une grande précision et une grande durabilité, et une finition mate.



DESCARGA ELECTROSTÁTICA / ELECTRO STATIC DISCHARGE / DÉCHARGE ÉLECTROSTATIQUE / ELEKTROSTATISCHE ABLADUNG / SCARICA ELETTRICITA STATICA /  
DESCARGA ELECTROSTÁTICA / РАЗРЯЖАТЕЛЬ СТАТИЧЕСКОГО ЭЛЕКТРИЧЕСТВА

■ ALICATES / PLIERS / PINCES / ZANGEN / PINZE / ALICATES / ЛОСКОГУБЦЫ

■ UNIVERSALES / COMBINATION / UNIVERSELLES / KOMBIZANGEN / UNIVERSALE / UNIVERSAIS / КОМБИНИРОВАННЫЕ

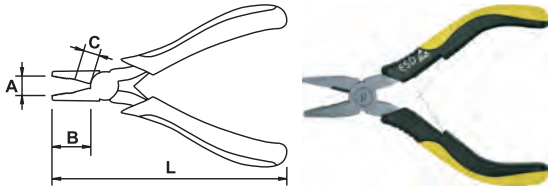

COD.	L (mm)	A (mm)	B (mm)	C (mm)						
64730	120	25	22	8	2	1,5	1	75	12	●



■ BOCA PLANA / FLAT NOSE / BECS PLATS / FLACHZANGEN / BECCHI PIATTI / PONTAS CHATAS / УТКОНОСЫ

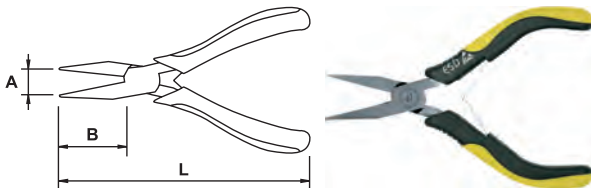

COD.	L (mm)	A (mm)	B (mm)			
64731	135	38	36	90	12	●



■ BOCA REDONDA / ROUND NOSE / BECS RONDOS / RUNDZANGEN / BECCHI TONDI / PONTAS REDONDAS / КРУГЛОГУБЦЫ

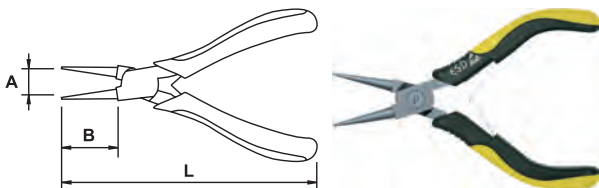

COD.	L (mm)	A (mm)	B (mm)			
64732	130	47	27	75	12	●



■ TELEFONISTA / LONG NOSE / TÉLÉPHONE / TELEFONZANGEN / TELEFONISTI / TELEFONISTA / СУДЛИННЕННЫМИ НОСАМИ

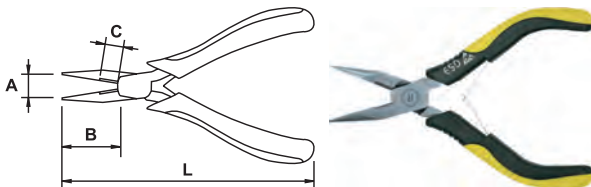

COD.	L (mm)	A (mm)	B (mm)	C (mm)						
64733	135	33	40	9	2	1,5	1	90	12	●





**DESCARGA ELECTROSTÁTICA / ELECTRO STATIC DISCHARGE / DÉCHARGE ÉLECTROSTATIQUE / ELEKTROSTATISCHE ABLADUNG / SCARICA ELETTRICITÀ STATICA /**  
**DESCARGA ELECTROSTÁTICA / РАЗРЯЖАТЕЛЬ СТАТИЧЕСКОГО ЭЛЕКТРИЧЕСТВА**

**TELEFONISTA BOCA CURVA / BENT NOSE PLIERS / TÉLÉPHONE BECS COUDÉS / TELEFONZANGEN GEBOGEN / TELEFONISTI BECCHI PIEGATI / TELEFONISTA PONTAS CURVAS / C**  
**ИЗОГНУТЫМИ НОСАМИ**

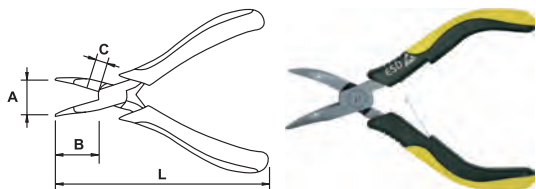

COD.	L (mm)	A (mm)	B (mm)	C (mm)						
64734	135	31	36	9	2	1,5	1	90	12	●

ESD **BI-MAT**

**BOCA AGUJA / LONG NEEDLE NOSE / BECS LONGS DEMI-RONDS / FLACHZANGE MIT LANGEM MAUL / BECCHI TONDI AFFUSOLATI / PONTAS AGULHA / УДЛИНЕННЫЕ ТОНКИЕ**

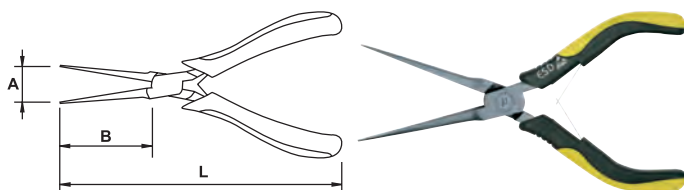

COD.	L (mm)	A (mm)	B (mm)			
64735	155	70	47	85	10	●

ESD **BI-MAT**

**CORTE DIAGONAL / DIAGONAL CUTTING PLIERS / COUPANTES DIAGONALES / SEITENSCHNEIDER / TAGLIO LATERALE / CORTE DIAGONAL / УДЛИНЕННЫЕ ТОНКИЕ**

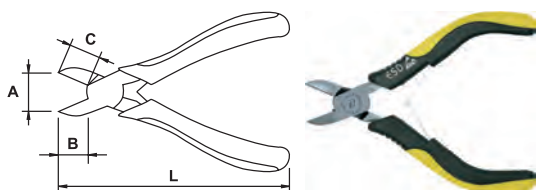

COD.	L (mm)	A (mm)	B (mm)	C (mm)						
64736	120	18	14	13	1,6	1,2	0,5	75	12	●

ESD **BI-MAT**

**CORTE FRONTAL / END CUTTING NIPPER / COUPANTES DEVANT / VORSCHNEIDER / TAGLIO FRONTALE / CORTE FRONTAL / КЛЕЩИ**

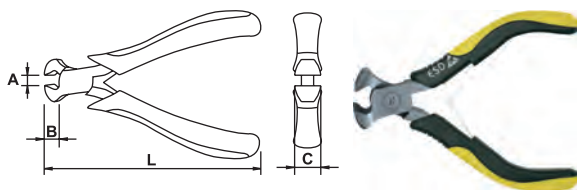

COD.	L (mm)	A (mm)	B (mm)	C (mm)						
64737	110	10	9	18	2	1	0,5	90	12	●

ESD **BI-MAT**

Blando / Soft / Tendre  
20 Kg/mm<sup>2</sup>

Medio / Medium / Moyen  
75 Kg/mm<sup>2</sup>

Duro / Hard / Dur  
180 Kg/mm<sup>2</sup>

Cuerda piano / Piano wire / Corde de piano  
230 Kg/mm<sup>2</sup>



DESCARGA ELECTROSTÁTICA / ELECTRO STATIC DISCHARGE / DÉCHARGE ÉLECTROSTATIQUE / ELEKTROSTATISCHE ABLADUNG / SCARICA ELETTRICITÀ STATICA /  
DESCARGA ELECTROSTÁTICA / РАЗРЯЖАТЕЛЬ СТАТИЧЕСКОГО ЭЛЕКТРИЧЕСТВА

PULSERA ANTIESTÁTICA / ANTI-STATIC WRIST STRAP / BRACELET ANTI STATIQUE / ANTISTATISCHES ERDUNGS-ARM BAND / POLSIERA ANTISTATICA / PULSEIRA ANTI-ESTÁTICA / БРАСЛЕТ АНТИСТАТИК

COD.			
64767	8ft	35	6



DESTORNILLADORES / SCREWDRIVERS / TOURNEVIS / SCHRAUBENZIEHER / CACCIAVITI / CHAVES DE FENDA / ОТВЕРТКИ

ELECTRICISTA / ELECTRICIAN / ELECTRICIEN / ELEKTRIK / PER ELETTRICISTI / ELETRICISTA / ЭЛЕКТРИЧЕСКАЯ

MM

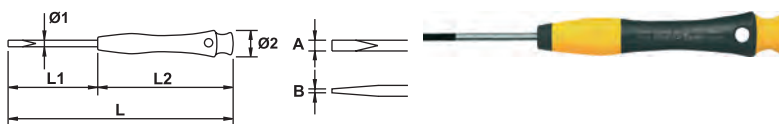

COD.	A (mm)	B (mm)	Ø 1 (mm)	Ø 2 (mm)	L (mm)	L1 (mm)	L2 (mm)			
64740	1	0,2			140	40		14		-
64741	1,5	0,3	2					16		
64742	2	0,4						17	10	
64743	2,5	0,4	2,5	16			100	19		
64744	3	0,5	3		160	60		21		•
64745	3,5	0,6	3,5					24		
64746	4	0,7	4							



INCH

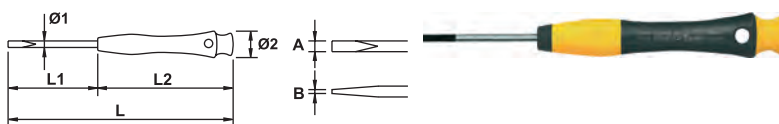

COD.	A (inch)	B (inch)	Ø 1 (mm)	Ø 2 (mm)	L (mm)	L1 (inch)	L2 (mm)			
55459		3/64			140			14		-
55460	5/64	1/16	2					16		
55461		5/64						19	10	
55463	1/8	1/8	3	16		2	100	21		
55464	9/64	9/64	3,5		160			24		•
55465	5/32	5/32	4							





**DESCARGA ELECTROSTÁTICA / ELECTROSTATIC DISCHARGE / DÉCHARGE ÉLECTROSTATIQUE / ELEKTROSTATISCHE ABLADUNG / SCARICA ELETTRICITÀ STATICA /  
 DESCARGA ELECTROSTÁTICA / РАЗРЯЖАТЕЛЬ СТАТИЧЕСКОГО ЭЛЕКТРИЧЕСТВА**

#### PHILIPS



COD.		Ø 1 (mm)	Ø 2 (mm)	L (mm)	L1 (mm)	L2 (mm)			
64747	PH00	2,5					17		-
64748	PH0	3,0	16	160	60	100	19	10	
64749	PH1	4,0					24		•



#### POZIDRIV®\*



COD.		Ø 1 (mm)	Ø 2 (mm)	L (mm)	L1 (mm)	L2 (mm)			
64753	PZ0	3,0					19		
64754	PZ1	4,0	16	160	60	100	24	10	•



#### TORX®\*\*



COD.		Ø 1 (mm)	Ø 2 (mm)	L (mm)	L1 (mm)	L2 (mm)		
64756	T4							
64757	T5	2,5	16	140	40	100	14	10
64758	T6							



#### TAMPER TORX



COD.		Ø 1 (mm)	Ø 2 (mm)	L (mm)	L1 (mm)	L2 (mm)			
64762	TT-7								
64763	TT-8	2,5		140	40		15		-
64764	TT-9	3,0	16	160	60	100	19	10	
64765	TT-10								•



\*Para tornillos POZIDRIV® (Marca registrada por European Ind. Serv. Ltd.) / \*For screws POZIDRIV® (European Ind. Serv. Ltd. registered trademark) / \*Pour vis POZIDRIV® (Marque enregistrée par European Ind. Serv. Ltd.)  
 \*\*Para tornillos TORX® (Marca registrada por Acument Intellectual Properties, LLC, Troy, Mich., US) / \*For screws TORX® (Acument Intellectual Properties, LLC, Troy, Mich., US registered trademark) / \*Pour vis TORX® (Marque enregistrée par Acument Intellectual Properties, LLC, Troy, Mich., US)



DESCARGA ELECTROSTÁTICA / ELECTROSTATIC DISCHARGE / DÉCHARGE ÉLECTROSTATIQUE / ELEKTROSTATISCHE ABLADUNG / SCARICA ELETTRICITÀ STATICA /  
DESCARGA ELECTROSTÁTICA / РАЗРЯЖАТЕЛЬ СТАТИЧЕСКОГО ЭЛЕКТРИЧЕСТВА

JUEGO DE ALICATES Y DESTORNILLADORES ESD / SET OF ESD PLIERS AND SCREWDRIVERS / SET DE PINCES ET TOURNEVIS ESD / SET ESD SCHRAUBENDREHER U-  
ZANGEN / SET PINZE E CACCIAVITI ESD / JOGO DE ALICATES E CHAVES ESD / НАБОР ПЛОСКОГУБЦЕВ И ОТВЕРТОК АНТИСТАТИЧЕСКИХ ESD

8 PCS.

COD.	PCS.
68898	8



PCS./UN.	COD.	PCS.	Descripción / Description / Description		
	64730		Alicate universal ESD / ESD Combination plier	115 mm	
	64736		Alicate corte diagonal ESD / ESD Diagonal cutting plier	-	
	64733		Alicate telefonista ESD / ESD Long nose plier	135 mm	
1	64742			2 x 60 mm	⊖
	64744			3 x 60 mm	
	64747		Destornilladores ESD / ESD Screwdrivers	PH00	⊕
	64748			PH0	
	64749			PH1	



JUEGO DE DESTORNILLADORES ESD / SET OF ESD SCREWDRIVERS / SET DE TOURNEVIS ESD / SET ESD SCHRAUBENDREHER / SET CACCIAVITI ESD / JOGO DE CHAVES ESD  
/ НАБОР ОТВЕРТОК АНТИСТАТИЧЕСКИХ ESD

6 PCS.

COD.	PCS.
68899	6



PCS./UN.	COD.	PCS.		
1	64747		PH00	⊕
	64748		PH0	
	64742		2 x 60 mm	⊖
	64744		3 x 60 mm	
	64753		PZ0	⊕
	64754		PZ1	



An aerial photograph of a large offshore oil rig in the middle of the ocean. The rig is a complex of steel structures, including a tall derrick, a yellow crane, and various platforms. The water is a deep blue, and the sky is a lighter blue with some clouds. A red diagonal shape is in the top right corner, and a grey diagonal shape is in the bottom left corner, framing the text.

**ExxonMobil**

**EXXONMOBIL  
(Nigeria)**

*Chidi Ahamefula*  
Central Tools Coordinator

"Safety is the watch word in our company and using EGA Master tools has helped us maintain that record over the years. Using the right tool helps you accomplish your task timely and safely, and EGA Master tools have consistently fulfilled that need for us."



# ANTIDROP

HERRAMIENTAS ANTI-CAÍDA ANTIDROP  
ANTIDROP TOOLS  
OUTILS ANTI-CHUTE ANTIDROP  
ANTIDROP WERKZEUG-SICHERUNG  
UTENSILI ANTI-CADUTA ANTIDROP  
FERRAMENTAS ANTI-QUEDA ANTIDROP  
ПРОТИВОУДАРНЫЕ ИНСТРУМЕНТЫ

# 3



DROPS

**EGA Master fabrica una amplia y completa gama de herramientas y soluciones anti-caída ANTIDROP, que han sido diseñadas para controlar y prevenir la caída de objetos cuando se trabaja en alturas.**

Estos productos han sido desarrollados para ofrecer un uso cómodo, productivo y eficiente, garantizando al mismo tiempo la seguridad de los trabajadores y equipos contra la caída de objetos. Son ideales para muchas actividades de fabricación, construcción, instalación y mantenimiento tanto en tierra como mar adentro.

Son muchas las aplicaciones que requieren de trabajos en alturas: torres de perforación, turbinas eólicas, líneas eléctricas, grúas, edificios, andamiajes, puentes, torres de telecomunicaciones, mantenimiento de aviones, minería, espeleología...

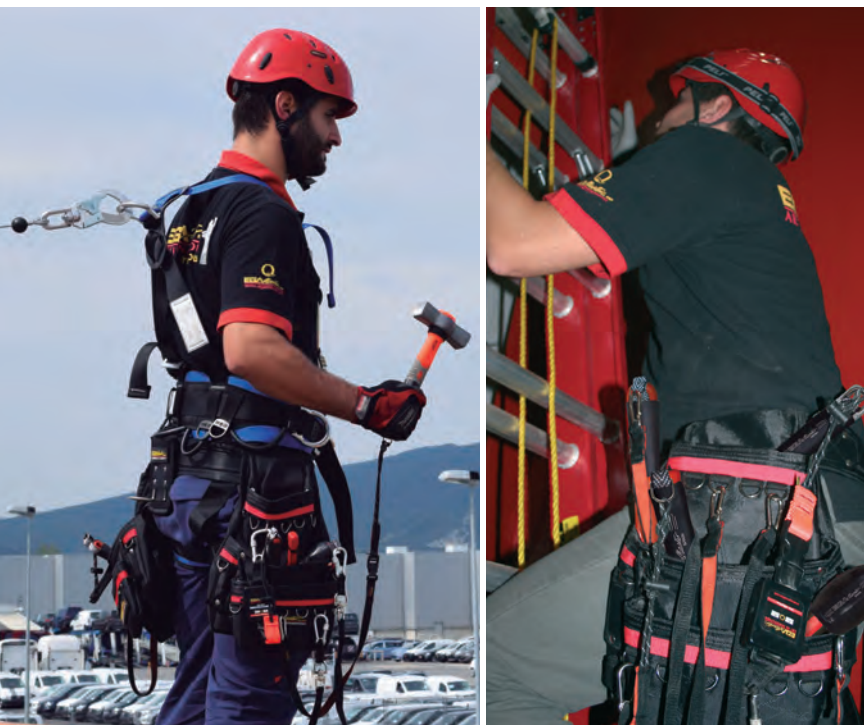

**EGA Master manufactures a whole range of ANTI - DROP products and solutions that have been designed to control and prevent object dropping when working at height.**

*These products have been designed to allow a comfortable, productive and efficient use of tools while assuring workers' and equipment safety against object dropping. Ideal for many manufacturing, construction, installation and maintenance activities, both onshore and offshore. Some applications: oil rigs, wind turbines, power lines, cranes, buildings, scaffolding, bridges, telecom towers, airplane maintenance, speleology, mining...*

**EGA Master fabrique une gamme vaste et complète d'outils avec des solutions anti-chute ANTIDROP, conçue pour contrôler et prévenir la chute d'objets lors de travaux en hauteurs.**

Ces produits ont été développés pour obtenir une utilisation pratique, productive et efficace, garantissant en même temps, la sécurité des travailleurs et des équipes, contre la chute d'objets. Ils sont idéals pour diverses activités de fabrication, de construction, d'installation et de maintenance terrestre et maritime.

Les situations ayant besoin du système anti-chute sont nombreuses: les tours de forage, les éoliennes, les lignes électriques, les grues, les bâtiments, les échafaudages, les ponts, les tours de télécommunications, la maintenance des avions, les mines, la spéléologie...

**La gama se compone de**  
*The range consists of*  
**La gamme se compose de**

**HERRAMIENTAS ANTI-CAÍDA ANTIDROP  
CON SISTEMA TERMORETRÁCTIL**  
*ANTIDROP TOOLS WITH HEAT SHRINK SYSTEM*  
**OUTILS ANTI-CHUTE ANTIDROP AVEC  
SYSTÈME THERMORÉTRACTABLE**

Las herramientas anti-caída ANTIDROP de EGA Master han sido cuidadosamente diseñadas no sólo para evitar caídas accidentales, sino para garantizar la seguridad completa. Todas las herramientas están equipadas con sistema termoretráctil mucho más eficaz y seguro que otros sistemas del mercado, como, por ejemplo, la sujeción de herramientas directamente mediante cordones y nudos que pueden fallar por errores humanos.

Por supuesto, todas las herramientas mantienen las características originales y reconocidas de las herramientas industriales de EGA Master: seguridad, resistencia, durabilidad, eficiencia, ergonomía y un uso cómodo.

*EGA Master ANTIDROP tools have been carefully designed not only to avoid accidental dropping, but also to ensure maximum safety. All tools are equipped with heat shrink system which offer superior safety compared to other systems, such as directly holding tools with a knot.*

*Of course, all tools keep the original and well-known EGA Master industrial tools features: safety, resistance, durability, efficient and comfortable use.*

Les outils anti-chute ANTIDROP d'EGA Master ont été soigneusement conçus, non seulement pour éviter des chutes accidentelles, mais aussi pour garantir la complète sécurité. Tous les outils sont dotés par un système thermorétractable, système beaucoup plus efficace et sûr que ceux existants sur le marché, comme par exemple la rétention directe d'outils par l'intermédiaire de cordons et de nœuds qui peuvent faire l'objet de défaillance par erreur humaine.

Il est évident que tous les outils gardent leurs caractéristiques originales et reconnues, des outils industriels d'EGA Master: sécurité, résistance, durabilité, efficacité, ergonomie et une utilisation confortable.



**CORDÓN ANTI-CAÍDA**  
**LANYARDS**  
**CORDON ANTI-CHUTE**

Diseñados para ofrecer la máxima seguridad, así como una óptima libertad de movimiento, los distintos sistemas proporcionan todas las soluciones necesarias para un uso cómodo y seguro en las alturas y al mismo tiempo aseguran la mejor absorción frente a impactos.

*Designed for maximum safety, as well as optimum working freedom, the various systems provide all required solutions for a comfortable and safe use on heights, while assuring best shock absorption.*

Conçus pour offrir la sécurité maximale, ainsi qu'une liberté de mouvement optimale, les différents systèmes offrent toutes les solutions nécessaires pour une utilisation pratique et sûre en hauteurs et en même temps assurent une meilleure absorption lors d'impacts.



**CINTURONES DE SEGURIDAD**  
**SAFETY BELTS**  
**CEINTURES DE SÉCURITÉ**

Diseñados para adaptarse a la perfección al cuerpo del trabajador, facilitan los movimientos del usuario, ofreciendo muchos y variados puntos de fijación para las herramientas. Los ganchos y bolsillos del cinturón sujetan las herramientas mientras el trabajador está en movimiento.

*Designed to fit the worker's body, enable user freedom and provide maximum tool fixing points. Internal hooks safely retain tools while the operator is climbing or moving location.*

Conçus pour s'adapter à la perfection au corps du travailleur, elles facilitent les mouvements de l'utilisateur en offrant une grande variété de points de fixation pour les outils. Les crochets et les poches de la ceinture supportent les outils pendant que le travailleur est en action.

**SISTEMA DE CONTROL DE HERRAMIENTAS**  
**TOOL CONTROL SYSTEM**  
**SYSTÈME DE CONTRÔLE D'OUTILS**

El control de herramientas es esencial en muchas aplicaciones, sobre todo en aquellos casos en los que las herramientas "perdidas" u olvidadas aumentan los riesgos y disminuyen la seguridad, como es el caso de reparaciones de aviones, mantenimiento de turbinas eólicas, construcciones en las alturas...

EGA Master ofrece como solución un exclusivo y personalizado sistema de control de herramientas. Simplemente hay que elegir las herramientas requeridas y EGA Master diseñará y fabricará el set necesario, totalmente personalizado, con bandejas bicolor que se adaptan perfectamente a las herramientas y permiten visualizar a golpe de vista la herramienta faltante. Para más información, dirigirse al capítulo "Sistemas de control de herramientas".

*Tool control is essential in many applications, specially on those where "forgotten" tools create high safety risks: airplane repair, wind turbine maintenance, construction at height...*

*EGA Master offers exclusive and totally customized tool control system solutions. Just decide which tools you need, and EGA Master will design and manufacture customized the set you require, with Bi-colored foam trays that perfectly fit tools and visually warn of any missing element. For more info, please check "Tool Control System" chapter.*

Le contrôle des outils est essentiel dans beaucoup d'applications, et surtout dans les cas où les outils "perdus" ou oubliés augmentent les risques et diminuent la sécurité, comme dans le cas de réparations d'avion, la maintenance d'éoliennes, les constructions en hauteurs...

EGA Master offre comme solution, un système exclusif et personnalisé de contrôle d'outils. Il suffit de sélectionner les outils désirés et EGA Master concevra et fabriquera le Set nécessaire, totalement personnalisé avec des plateaux bi-couleurs qui s'adaptent parfaitement aux outils et permettent de visualiser d'un simple coup d'œil l'outil manquant. Pour plus d'informations, se diriger au Chapitre "Systèmes de Contrôle d'Outils".





**SOLUCIONES ANTI-CAÍDA PARA HERRAMIENTA AISLADA 1.000V, ESD, ANTI-CHISPA O NO MAGNÉTICA**  
**ANTIDROP SOLUTIONS FOR 1000V INSULATED, ESD, NON-SPARKING OR NON-MAGNETIC TOOLS**  
**SOLUTIONS ANTI-CHUTE POUR DES OUTILS ISOLÉS 1000 VOLTS, ESD, ANTI-DÉFLAGRANTS ET AMAGNÉTIQUES**

Si usted requiere de herramienta de este tipo con el sistema anti-caída ANTIDROP incorporado, debido a sus propiedades especiales, por favor, póngase en contacto con EGA Master para asesorarle y ofrecerle la mejor solución posible.

*If you require such tools in ANTIDROP execution, due to their special properties, please do contact us to advice the best possible solution.*

Si vous avez besoin d'outils de ce type avec le système anti-chute ANTIDROP incorporé, et en raison de leurs propriétés spécifiques, merci de vous mettre en contact avec EGA Master pour une étude technique et vous offrir la solution la plus adaptée.

EGA Master es miembro de DROPS, iniciativa global de colaboración intersectorial para el establecimiento de normas y soluciones para la prevención de caída de objetos, representada por las empresas más avanzadas y concienciadas en seguridad de los distintos sectores: Petróleo, Gas, Minería, Construcción, Fabricación, Seguridad, etc.



Como miembro de dicha iniciativa, EGA Master diseña, ensaya, homologa, certifica y fabrica todas sus herramientas y sujeciones ANTIDROP (prevención frente a caídas) de acuerdo siempre a las últimas recomendaciones DROPS vigentes, asegurando los más altos estándares de seguridad frente a la caída de objetos. Todo ello en combinación con la calidad industrial de primer nivel de sus herramientas, garantiza que las soluciones ANTIDROP de EGA Master cumplan con las más altas exigencias de eficiencia, productividad, comodidad y seguridad.

*EGA Master is a member of DROPS, a global initiative for inter-sector collaboration for the establishment of standards and solutions to prevent falling objects, represented by companies that are the most advanced and safety aware across multiple sectors: such as Oil, Gas, Mining, Construction, Manufacturing, Safety, etc.*

*As a member of this initiative, EGA Master has designed, manufactured, tested, approved and certified all its ANTIDROP (prevention against falls) tools and accessories according to the latest standards of security and recommendations provided by DROPS,*

*ensuring the highest standards of security against falling objects. All this, combined with industrial class quality tools, ensures that EGA Master ANTIDROP solutions meet the highest standards of efficiency, productivity, comfort and safety.*

**EGA Master est membre de DROPS, initiative globale de collaboration intersectorielle pour l'établissement de normes et de solutions pour la prévention de chute d'objets, représentée par les entreprises les plus avancées et conscientes de l'importance de la sécurité dans les secteurs suivants: Pétrole, Gaz, industrie minière, Construction, Fabrication, Sécurité, etc.**

En tant que membre de telle initiative, EGA Master conçoit, essaie, homologue, certifie et fabrique tous ses outils et fixations ANTIDROP (prévention par rapport à la chute) toujours en accords aux dernières recommandations DROPS en vigueur, assurant les plus hauts standards de sécurité par rapport à la chute d'objets. Tout cela, combiné avec la qualité industrielle de premier niveau de ses outils, garantit que les solutions ANTIDROP d'EGA Master accomplissent les plus hautes exigences d'efficacité, de productivité, de commodité et sécurité.

**CAÍDA LIBRE**  
**FREE FALL**  
**CHUTE LIBRE**



Se une el lanyard a un punto de anclaje y al otro extremo se le aplica la carga. La carga se eleva y se suelta verticalmente, 5 veces.

*The lanyard is attached to an anchor point and the weight is applied to the other end. Then the weight is elevated and dropped vertically, five times.*

Le lanyard se joint à un point d'ancrage et la charge s'applique sur l'autre extrémité. La charge s'élève et se lâche verticalement, 5 fois.

**CAÍDA PENDULAR**  
**PENDULAR TEST**  
**CHUTE PENDULAIRE**

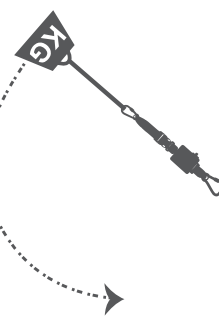

Se une el lanyard a un punto de anclaje y al otro extremo se le aplica la carga. Se eleva la carga por encima del punto de anclaje y se suelta, 5 veces.

*The lanyard is attached to an anchor point and the weight is applied to the other end. Then the weight is elevated above the anchorage point and dropped, five times.*

Le lanyard se joint à un point d'ancrage et la charge s'applique sur l'autre extrémité. La charge s'élève au-dessus du point d'ancrage et se lâche, 5 fois.

**CARGA ESTÁTICA**  
**STATIC LOAD TEST**  
**CHARGE STATIQUE**



Se une el lanyard a un punto de anclaje y en el otro extremo se aplica la carga durante 10 minutos.

*The lanyard is attached to an anchor point and the weight is applied to the other end during 10 minutes.*

Le lanyard se joint à un point d'ancrage et sur l'autre extrémité la charge s'applique pendant 10 minutes.



■ **CORDÓN ANTICAÍDA / LANYARDS / CORDON ANTI-CHUTE / SICHERUNGS-LEINE / CORDINO ANTI-CADUTA / SUPORTE DE SEGURANÇA / СТРОПЫ**

■ **CORDÓN ANTICAÍDA RETRÁCTIL / RETRACTABLE LANYARD / CORDON ANTI-CHUTE RÉTRACTABLE / SICHERUNGS-LEINE, SELBST AUFROLLEND / CORDINO ANTI-CADUTA RETRATTILE / SUPORTE DE SEGURANÇA RETRÁCTIL / ВЫДВИГАЮЩИЕСЯ СТРОПЫ**

COD.	L (mm)	L max. (m)		CAP. (kg)					
<b>66078</b>	440	1,5	1	0,9	0,9	3	30	160	1



■ **CORDÓN ANTICAÍDA RETRÁCTIL CON MOSQUETÓN / RETRACTABLE LANYARD WITH CARABINER / CORDON ANTI-CHUTE RÉTRACTABLE AVEC MOUSQUETON / SICHERUNGS-LEINE, SELBST AUFROLLEND, KARABINERHAKEN / CORDINO ANTI-CADUTA RETRATTILE CON MOSCHETTONE / SUPORTE DE SEGURANÇA RETRÁCTIL COM MOSQUETÃO / ВЫДВИГАЮЩИЕСЯ СТРОПЫ С КАРАБИНОМ**

COD.	L (mm)	L max. (m)		CAP. (kg)					
<b>66062</b>	400	1,4	1	0,9	0,9	3	30	190	1



■ **ACCESORIOS / ACCESSORIES / ACCESSOIRES / ERSATZTEILE / ACCESSORI / ACESSORIOS / ЗАПАСНЫЕ ЧАСТИ**

COD.	L (mm)		
<b>66063</b>	240	15	1



COD.	L (mm)		
<b>66064</b>	200	45	1



COD.	L (mm)		
<b>66068</b>	270	20	1



■ **CORDÓN ANTICAÍDA CON MOSQUETÓN Y QUITAVUELTAS / CARABINER LANYARD WITH SWIVEL / CORDON ANTI-CHUTE AVEC MOUSQUETON ET ANTI-ENROULEMENT / KARABINER LEINE MIT GELENK / CORDONE ANTI-CADUTA CON MOSCHETTONE E PERNO GIREVOLE / SUPORTE ANTI-QUEDA COM MOSQUETÃO E CONECTOR GIRATÓRIO / СТРОП ПРОТИВОУДАРНЫЙ ПОВОРОТНЫЙ С КАРАБИНОМ**

COD.	L (mm)	L max. (m)	Resistant UV / UV Resistant / UV Resistant	CAP. (kg)					
<b>66112</b>	1000	1,7	●	0,9	0,9	1	20	135	1



**CARACTERÍSTICAS / FEATURES / CARACTÉRISTIQUES**

Nylon de alta resistencia a los rayos ultravioleta con mosquetones de acero / UV high resistance nylon and steel carabiners / Nylon à haute résistance aux rayons ultraviolets avec mosquetons en acier

Elástico / Elastic / Élastique



COD.	L (mm)	Resistant UV / UV Resistant / UV Resistant	CAP. (kg)					
<b>66116</b>	700	●	3	3	5	35	125	1



**CARACTERÍSTICAS / FEATURES / CARACTÉRISTIQUES**

Poliéster resistente a los rayos ultravioleta y nylon de alta resistencia con mosquetones de acero / *UV resistant polyester and high resistance nylon and steel carabiners* / Polyester résistant aux rayons ultraviolets et nylon à haute résistance avec mousquetons en acier

Rígido / Rigid / Rigide

**CORDÓN ANTICAÍDA CON MOSQUETÓN / CARABINER LANYARD / CORDON ANTI-CHUTE AVEC MOUSQUETON / SICHERUNGS-LEINE, KARABINERHAKEN / CORDINO ANTI-CADUTA CON MOSCHETTONE / SUPORTE DE SEGURANÇA COM MOSQUETÃO / СТРОПЫ С КАРАБИНОМ**

COD.	L (mm)	Resistant UV / UV Resistant / UV Resistant	CAP. (kg)					
<b>66108</b>	500	●	3	3	5	35	40	1



**CARACTERÍSTICAS / FEATURES / CARACTÉRISTIQUES**

Poliéster resistente a los rayos ultravioleta y nylon de alta resistencia con mosquetones de acero / *UV resistant polyester and high resistance nylon and steel carabiners* / Polyester résistant aux rayons ultraviolets et nylon à haute résistance avec mousquetons en acier

Rígido / Rigid / Rigide

**CORDÓN ANTICAÍDA DE NUDO Y QUITAVUELTAS / LOOP LANYARD WITH SWIVEL / CORDON ANTI-CHUTE AVEC NOEUD ET ANTI-ENROULEMENT / SCHLEIFLEINE MIT GELENK / CORDONE ANTI-CADUTA NODO E PERNO GIREVOLE / SUPORTE ANTI-QUEDA COM CORDÃO E CONECTOR GIRATÓRIO / СТРОП ПРОТИВОУДАРНЫЙ ПОВОРОТНЫЙ С ПЕТЛЕЙ**

COD.	L (mm)	L max. (m)	Resistant UV / UV Resistant / UV Resistant	CAP. (kg)					
<b>66113</b>	880	1.5	●	0,9	0,9	1	20	80	1



**CARACTERÍSTICAS / FEATURES / CARACTÉRISTIQUES**

Nylon de alta resistencia a los rayos ultravioleta con mosquetón de acero / *UV high resistance nylon and steel carabiner* / Nylon à haute résistance aux rayons ultraviolets avec mousquetons en acier

Elástico / Elastic / Élastique

COD.	L (mm)	Resistant UV / UV Resistant / UV Resistant	CAP. (kg)					
<b>66117</b>	630	●	3	3	5	35	70	1



**CARACTERÍSTICAS / FEATURES / CARACTÉRISTIQUES**

Poliéster resistente a los rayos ultravioleta y nylon de alta resistencia con mosquetones de acero / *UV resistant polyester and high resistance nylon and steel carabiners* / Polyester résistant aux rayons ultraviolets et nylon à haute résistance avec mousquetons en acier

Rígido / Rigid / Rigide

**CORDÓN ANTICAÍDA DE NUDO / LOOP LANYARD / CORDON ANTI-CHUTE AVEC NOEUD / SICHERUNGS-LEINE, SCHLAUFE / CORDINO ANTI-CADUTA CON ANELLO / SUPORTE DE SEGURANÇA COM CORDÃO / СТРОПЫ С ПЕТЛЕЙ**

COD.	L (mm)	Resistant UV / UV Resistant / UV Resistant	CAP. (kg)					
<b>66109</b>	500	●	3	3	5	35	30	1



**CARACTERÍSTICAS / FEATURES / CARACTÉRISTIQUES**

Poliéster resistente a los rayos ultravioleta y nylon de alta resistencia con mosquetones de acero / *UV resistant polyester and high resistance nylon and steel carabiners* / Polyester résistant aux rayons ultraviolets et nylon à haute résistance avec mousquetons en acier

Rígido / Rigid / Rigide



**CORDÓN ANTICAÍDA CON CUERDA ESCALADA CON MOSQUETÓN / CLIMBING ROPE CARABINER LANYARD / CORDON ANTI-CHUTE AVEC CORDE D'ESCALADE AVEC MOUSQUETON / KLETTERSEIL KARABINER SCHLÜSSELBAND / CORDONE ANTICADUTA A CORDA PER ARRAMPICATA CON MOSCHETTONE / CORDA ANTI-QUEDA COM CORDA DE ESCALADA E MOSQUETÃO / СТРАХОВОЧНЫЙ ТРОС С КАРАБИНОМ**

COD.	L (mm)	L max. (m)	Resistant UV / UV Resistant / UV Resistant	CAP. (kg)					
<b>66105</b>	500	500	-	10	10	15	100	350	1



**CARACTERÍSTICAS / FEATURES / CARACTÉRISTIQUES**

Cuerda de escalada Terylene® con mosquetones de acero / Terylene® climbing rope and steel carabiners / Corde d'escalade Térylène® avec mousquetons en acier

Rígido / Rigid / Rigide

**CINTURÓN PORTAHERRAMIENTAS / TOOL BELT / CEINTURE PORTE - OUTILS / WERKZEUGGÜRTEL / CINTURA PORTAUTENSILI / CINTURAO PORTA FERRAMENTAS / ИНСТРУМЕНТАЛЬНЫЙ ПОЯС**

COD.	L (inch)					Anillas / Rings / Anneaux	
<b>50997</b>	32-44	15	10	3	4	35	21



**ACCESORIOS / ACCESSORIES / ACCESSOIRES / ERSATZTEILE / ACCESSORI / ACESSORIOS / ЗАПАСНЫЕ ЧАСТИ**

COD.			Anillas / Rings / Anneaux
<b>50998</b>			1
<b>50999</b>	10	3	2



**BOLSA 14 BOLSILLOS / 14 POCKETS NYLON BAG / TROUSSE 14 POCHEs / NYLON TASCHE MIT 14 FÄCHER / BORSA CON 14 TASCHE / BOLSA 14 BOLSOS / НЕЙЛОНОВАЯ СУМКА (14 ОТДЕЛЕНИЙ)**

COD.		
<b>50934</b>	14	275



**BOLSA 7 BOLSILLOS / 7 POCKETS NYLON BAG / TROUSSE 7 POCHEs / NYLON TASCHE MIT 7 FÄCHER / BORSA CON 7 TASCHE / BOLSA 7 BOLSOS / НЕЙЛОНОВАЯ СУМКА (7 ОТДЕЛЕНИЙ)**

COD.		
<b>50935</b>	7	245



• Para más información de dimensiones y características del producto, consultar en el capítulo correspondiente del catálogo general o en [www.egamaster.com](http://www.egamaster.com). / For more details about features and dimensions of the products, check the corresponding chapter of the General Catalogue or [www.egamaster.com](http://www.egamaster.com). / Pour plus d'informations sur les dimensions et les caractéristiques du produit, consulter le chapitre correspondant de notre catalogue général ou sur [www.egamaster.com](http://www.egamaster.com).



ACCESORIO PARA MARTILLO / ACCESSORY FOR HAMMER / ACCESSOIRE POUR MARTEAU / ZUBEHÖR F/HAMMER / ACCESSORIO PER MARTELLO / ACESSÓRIO PARA MARTELO / ПОЯСНОЙ КАРМАН ДЛЯ МОЛОТКА

COD.	
50932	92



CINTO / BELT / CEINTURE / RIEM / CINTURONE / CINTO / ПОЯС

COD.	L (mm)	
50933	135	260



ALICATES / PLIERS / PINCES / ZANGEN / PINZE / ALICATES / ПЛОСКОГУБЦЫ

MASTERCUT TITACROM® BIMAT

UNIVERSALES / COMBINATION / UNIVERSELLES / KOMBIZANGEN / UNIVERSALE / UNIVERSAIS / КОМБИНИРОВАННЫЕ



COD.	L (mm)
AD624957	165
AD624967	180
AD624797	210

TITACROM® BIMAT | DIN 5746

CARACTERÍSTICAS / FEATURES / CARACTÉRISTIQUES

Cr-V



COD.	L (mm)
AD624807	235

TITACROM® BIMAT | DIN 5746

CARACTERÍSTICAS / FEATURES / CARACTÉRISTIQUES

Cr-V

TELEFONISTA / LONG NOSE / TÉLÉPHONE / TELEFONZANGEN / TELEFONISTI / TELEFONISTA / С УДЛИННЕННЫМИ НОСАМИ



COD.	L (mm)
AD624987	160
AD624997	200

TITACROM® BIMAT | DIN 5745

CARACTERÍSTICAS / FEATURES / CARACTÉRISTIQUES

Cr-V

TELEFONISTA BOCA CURVA / BENT NOSE PLIERS / TÉLÉPHONE BECS COUDÉS / TELEFONZANGEN GEBOGEN / TELEFONISTI BECCHI PIEGATI / TELEFONISTA PONTAS CURVAS / С ИЗОГНУТЫМИ НОСАМИ



COD.	L (mm)
AD625007	160
AD625017	200

TITACROM® BIMAT | DIN 5745

CARACTERÍSTICAS / FEATURES / CARACTÉRISTIQUES

Cr-V

CORTE DIAGONAL / DIAGONAL CUTTING PLIERS / COUPANTES DIAGONALES / SEITENSCHNEIDER / TAGLIO LATERALE / CORTE DIAGONAL / БОКОРЕЗЫ



COD.	L (mm)
AD622997	160
AD623507	190

TITACROM® BIMAT | DIN 5749

CARACTERÍSTICAS / FEATURES / CARACTÉRISTIQUES

Cr-V

CORTE DIAGONAL REFORZADO / HEAVY DUTY CUTTING NIPPERS / COUPANTES RENFORCÉS / VERSTÄRKTER SEITENSCHNEIDER / TAGLIO LATERALE RINFORZATO / CORTE DIAGONAL REFORÇADO / УСИЛЕННЫЕ БОКОРЕЗЫ



COD.	L (mm)
AD623007	180
AD625987	200

TITACROM® BIMAT | DIN 5749

CARACTERÍSTICAS / FEATURES / CARACTÉRISTIQUES

Cr-V



ACO

## TITACROM® BIMAT

UNIVERSALES / COMBINATION / UNIVERSELLES / KOMBIZANGEN / UNIVERSALE /  
 UNIVERSAIS / КОМБИНИРОВАННЫЕ



COD.	L (mm)
AD623317	165
AD623327	180
AD623337	200

TITACROM® BIMAT | DIN 5746

CARACTERÍSTICAS / FEATURES / CARACTÉRISTIQUES

Cr-V

BOCA PLANA / FLAT NOSE / BECS PLATS / FLACHZANGEN / BECCHI PIATTI / PONTAS  
 CHATAS / УТКОНОСЫ



COD.	L (mm)
AD623377	160

TITACROM® BIMAT | DIN 5745

CARACTERÍSTICAS / FEATURES / CARACTÉRISTIQUES

Cr-V

BOCA REDONDA / ROUND NOSE / BECS RONDOS / RUNDZANGEN / BECCHI TONDI /  
 PONTAS REDONDAS / КРУГЛОГУБЦЫ



COD.	L (mm)
AD623387	160

TITACROM® BIMAT | DIN 5745

CARACTERÍSTICAS / FEATURES / CARACTÉRISTIQUES

Cr-V

TELEFONISTA / LONG NOSE / TÉLÉPHONE / TELEFONZANGEN / TELEFONISTI /  
 TELEFONISTA / СУДЛИННЕННЫМИ НОСАМИ



COD.	L (mm)
AD623397	160
AD623407	200

TITACROM® BIMAT | DIN 5745

CARACTERÍSTICAS / FEATURES / CARACTÉRISTIQUES

Cr-V

TELEFONISTA BOCA CURVA / BENT NOSE PLIERS / TÉLÉPHONE BECS COUDÉS /  
 TELEFONZANGEN GEBOGEN / TELEFONISTI BECCHI PIEGATI / TELEFONISTA PONTAS  
 CURVAS / С ИЗГНУТЫМИ НОСАМИ



COD.	L (mm)
AD623417	160
AD623427	200

TITACROM® BIMAT | DIN 5745

CARACTERÍSTICAS / FEATURES / CARACTÉRISTIQUES

Cr-V

CORTE DIAGONAL / DIAGONAL CUTTING PLIERS / COUPANTES DIAGONALES /  
 SEITENSCHNEIDER / TAGLIO LATERALE / CORTE DIAGONAL / БОКОРЕЗЫ



COD.	L (mm)
AD623437	160
AD625407	190

TITACROM® BIMAT | DIN 5749

CARACTERÍSTICAS / FEATURES / CARACTÉRISTIQUES

Cr-V

CORTE DIAGONAL REFORZADO / HEAVY DUTY CUTTING NIPPERS / COUPANTES  
 RENFORCÉS / VERSTÄRKTER SEITENSCHNEIDER / TAGLIO LATERALE RINFORZATO /  
 CORTE DIAGONAL REFORÇADO / УСИЛЕННЫЕ БОКОРЕЗЫ



COD.	L (mm)
AD623447	180
AD623707	200

TITACROM® BIMAT | DIN 5749

CARACTERÍSTICAS / FEATURES / CARACTÉRISTIQUES

Cr-V

• Para más información de dimensiones y características del producto, consultar en el capítulo correspondiente del catálogo general o en [www.egamaster.com](http://www.egamaster.com). / For more details about features and dimensions of the products, check the corresponding chapter of the General Catalogue or [www.egamaster.com](http://www.egamaster.com). / Pour plus d'informations sur les dimensions et les caractéristiques du produit, consulter le chapitre correspondant de notre catalogue général ou sur [www.egamaster.com](http://www.egamaster.com).

ACO

CORTE FRONTAL / END CUTTING NIPPER / COUPANTES DEVANT / VORSCHNEIDER /  
 TAGLIO FRONTALE / CORTE FRONTAL / КЛЕЩИ



COD.	L (mm)
AD623457	160

TITACROM® BIMAT | DIN 5748

CARACTERÍSTICAS / FEATURES / CARACTÉRISTIQUES

Cr-V

CORTE FRONTAL ELECTRICISTA / END CUTTING NIPPER (ELECTRICIAN) / COUPANTES  
 DEVANT ELECTRICIEN / ELEKTRIKER VORSCHNEIDER / TAGLIO FRONTALE PER  
 ELETRICISTI / CORTE FRONTAL ELETTRICISTA / КЛЕЩИ (ЭЛЕКТРИЧЕСКИЕ)



COD.	L (mm)
AD623467	160
AD623487	200

TITACROM® BIMAT | DIN 5748

CARACTERÍSTICAS / FEATURES / CARACTÉRISTIQUES

Cr-V

MINIS PARA ELECTRÓNICA / ELECTRONIC PLIERS / PINCES ELECTRONIQUES / ELEKTRONIK-ZANGEN / PINZE PER ELETTRONICA / ALICATE DE CORTE DIAGONAL  
 TRIANGULAR PARA ELECTRÓNICA / ПЛОСКОГУБЦЫ ДЛЯ ЭЛЕКТРОНИКИ

TITACROM® BIMAT

UNIVERSALES / COMBINATION / UNIVERSELLES / KOMBIZANGEN / UNIVERSALE /  
 UNIVERSAIS / КОМБИНИРОВАННЫЕ



COD.	L (mm)
AD622417	125

TITACROM® BIMAT | DIN 9655

CORTE DIAGONAL REFORZADO / HEAVY DUTY CUTTING NIPPERS / COUPANTES  
 RENFORCÉS / VERSTÄRKTER SEITENSCHNEIDER / TAGLIO LATERALE RINFORZATO /  
 CORTE DIAGONAL REFORÇADO / УСИЛЕННЫЕ БОКОРЕЗЫ



COD.	L (mm)
AD622477	115

TITACROM® BIMAT | DIN 9654

PELACABLES / WIRESTRIPPER / PINCES À DÉNUDER / ABISOLIERZANGEN / PINZE  
 SPELAFILI / DECAPADORES / КЛЕЩИ ДЛЯ ЗАЧИСТКИ КОНТАКТОВ



COD.	L (mm)
AD623497	160

TITACROM® BIMAT | DIN 5743

CARACTERÍSTICAS / FEATURES / CARACTÉRISTIQUES

Cr-V

BOCA REDONDA / ROUND NOSE / BECS RONDS / RUNDZANGEN / BECCHI TONDI /  
 PONTAS REDONDAS / КРУГЛОГУБЦЫ



COD.	L (mm)
AD622437	130

TITACROM® BIMAT | DIN 9655



**ELECTRICIDAD / ELECTRICIAN TOOLS / OUTILLAGE D'ÉLECTRICIEN / WERKZEUGE FÜR ELEKTRIKER / UTENSILI PER ELETTRICISTI / ELECTRICIDADE / ИНСТРУМЕНТ ДЛЯ ЭЛЕКТРИКОВ**

**PARA TERMINALES AISLADOS / FOR INSULATED TERMINALS / POUR TERMINAUX ISOLÉS / FÜR ISOLIERTE KABELSCHUHE / PER TERMINALI ISOLATI / PARA TERMINAIS ISOLADOS / ДЛЯ ИЗОЛИРОВАННЫХ КОНТАКТОВ**



COD.	L (mm)
AD624937	200

**TENAZAS CORTACABLES / CABLE CUTTERS / COUPE-CABLES / KABELSCHNEIDER / CESCOIE PER CAVI / TESOURAS CORTA CABOS / КАБЕЛЕРЕЗЫ**



COD.	L (mm)
AD621517	250

**TIJERA ELECTRICISTA / ELECTRICIAN'S SCISSORS / CISEAUX ÉLECTRICIEN / ELEKTRIKERSCHERE / FORBICI PER ELETTRICISTI / TESOURA ELETTRICISTA / ЭЛЕКТРИЧЕСКИЕ НОЖНИЦЫ**



COD.	L (mm)
AD695347	145



COD.	L (mm)
AD695357	145

**TENAZAS / PINCERS / PINCES / ZANGE / TENAGLIE / ALICATES / КЛЕЩИ**

**DE CANAL / BOX JOINT / MULTIPRISE ENTREPASSÉE / WASSERPUMPENZANGE / PINZE REGOLABILI / BICO DE PAPAGAIO / КЛЕЩИ ШАРНИРНЫЕ**

**TITACROM® BIMAT**



COD.	L (inch)
AD622977	10
AD622987	12

**TITACROM® BIMAT | DIN 8976**

**PICO DE LORO / GROOVE JOINT / MULTIPRISE À CRÉMAILLÈRE / WASSERPUMPENZANGE / PINZE REGOLABILI / BICO DE PAPAGAIO / КЛЕЩИ ЖЕЛОбКОВОГО ТИПА**

**TITACROM®**



COD.	L (inch)
AD621067	10

**TITACROM® | DIN 8976**

**ALICATE TRENZADOR DE ALAMBRE / WIRE TWIST PLIER / PINCE À FREINER / DRAHTWIRBELZANGE / PINZA TORCIFILO / ALICATE TORCEDOR DE ARAME / КЛЕЩИ ДЛЯ ТРОСОВ**

**REVERSIBLE / REVERSIBLE / RÉVERSIBLE / UMSCHALTBAR / REVERSIBILE / REVERSÍVEL / РЕВЕРСИВНЫЙ**



COD.	L (inch)
AD626277	6

**ALICATE TIPO FORD / SLIP JOINT PLIER / PINCE MOTORISTE / MECHANIKERZANGE / PINZE PER GASISTI / ALICATE MOTORISTA / СКОЛЬЗЯЩИЕ КЛЕЩИ**

**TITACROM®**



COD.	L (inch)
AD620917	8

**TITACROM®**



LLAVES AJUSTABLES / ADJUSTABLE WRENCHES / CLÉS À MOLETTE / ROLLGABELSCHLÜSSEL / CHIAVI REGOLABILI A RULLINO / CHAVES AJUSTAVELS / РАЗВОДНЫЕ КЛЮЧИ

TITACROM®



COD.	L (mm)	L (inch)
AD611097	100	4
AD611107	150	6
AD611117	200	8
AD611127	250	10
AD611137	300	12

COD.	L (mm)	L (inch)
AD611157	450	18

TITACROM®

TITACROM®

LLAVES / WRENCHES / CLÉS / SCHLÜSSEL / CHIAVI / CHAVES / КЛЮЧИ

DE VASO DOBLE ARTICULACIÓN / DOUBLE ENDED SWIVEL / CLÉ À TUBE ARTICULÉE /  
 DOPPEL-GELENKSTECKSCHLÜSSEL / CHIAVE A BUSSOLA DOPPA SNODABILE / DE  
 CAIXA ARTICULADAS / КЛЮЧ ДВОЙНАЯ ГОЛОВКА ШАРНИРНАЯ

ESTRELLA PLANA / DOUBLE ENDED FLAT RING SPANNER / POLIGONALE PLATE /  
 DOPPELRINGSCHLÜSSEL / POLIGONALE DIRITTA / LUNETTA DIRETTA / ДВОЙНАЯ  
 ИЗГНУТАЯ ПЛОСКАЯ ЗВЕЗДОЧКА



COD.	AF mm
AD613017	8-9
AD613027	10-11
AD613037	12-13
AD613047	14-15
AD613057	16-17
AD613067	18-19
AD613087	20-22
AD613097	21-23
AD613107	24-27

COD.	AF mm
AD607707	6-7
AD607717	8-9
AD607727	10-11
AD607737	12-13
AD607747	14-15
AD607757	16-17
AD607767	17-19
AD607777	18-19
AD607787	20-22
AD607797	21-23
AD607807	24-27
AD607817	25-28
AD607827	30-32

DIN 837

CARACTERÍSTICAS / FEATURES / CARACTÉRISTIQUES

CR-V

PARA RACORES / FLARE NUT / POLIGONALE À TUYAUTER / OFFENER  
 DOPPELRINGSCHLÜSSEL / CHIAVE PER RACCORDI / LUNETAS ABERTAS COM BATENTE /  
 КЛЮЧ ДЛЯ КОНИЧЕСКИХ ГАЕК



COD.	AF mm
AD607857	8-10
AD607887	11-13
AD607897	12-14
AD607907	17-19
AD607927	22-24

DIN 3118

CARACTERÍSTICAS / FEATURES / CARACTÉRISTIQUES

CR-V



JUEGOS / SETS / ASSORTIMENTS / SÄTZE / ASSORTIMENTI / JOGOS / НАБОРЫ

COD.	mm	inch
AD614997	1,5-6	-
AD615007	1,5-10	-
AD615167	-	1/16-3/8

Standard



COD.	mm
AD615127	2,5-10

Serie larga / Long serie / Série longue



COD.	mm	inch
AD614967	1,5-10	-
AD614957	-	1/16-3/8

Bola / Ballpoint / Tête sphérique | Serie larga / Long serie / Série longue



COD.	mm	inch	
AD653527	1,5-8	-	-
AD653537	-	5/64-5/16	-
AD653547	-	-	T9-T40



LLAVE DE CARRACA PARA ESTRUCTURA METÁLICA / PODGING WRENCH / CLÉ À CLIQUET POUR STRUCTURE MÉTALLIQUE / STAHLBAUKNARRE / CHIAVE A CRICCO PER COSTRUZIONE / CHAVE DE ROQUETE PARA ESTRUTURA METALICA / ГОЛОВКА С ТРЕЩЕТКОЙ

COD.	mm
AD659167	10-13
AD650767	17-19
AD659177	19-21
AD650777	19-22
AD650787	19-24
AD650797	24-30
AD650807	27-32
AD650817	36-41



• Para más información de dimensiones y características del producto, consultar en el capítulo correspondiente del catálogo general o en [www.egamaster.com](http://www.egamaster.com). / For more details about features and dimensions of the products, check the corresponding chapter of the General Catalogue or [www.egamaster.com](http://www.egamaster.com). / Pour plus d'informations sur les dimensions et les caractéristiques du produit, consulter le chapitre correspondant de notre catalogue général ou sur [www.egamaster.com](http://www.egamaster.com).



**LLAVES DE GOLPE SEGURIDAD TOTAL / TOTAL SAFETY SLOGGING WRENCHES / CLÉS À FRAPPER SÉCURITÉ ASSURÉE / SCHLAGRINGSCHLÜSSEL MIT SICHERUNG / CHIAVI A BATTERE SICUREZZA TOTALE / CHAVES DE LUNETA SÉRIE PANCADA DE SEGURANÇA TOTAL / КОЛЬЦЕВОЙ УДАРНЫЙ КЛЮЧ-ЗВЕЗДОЧКА С ПОДВЕСОМ**

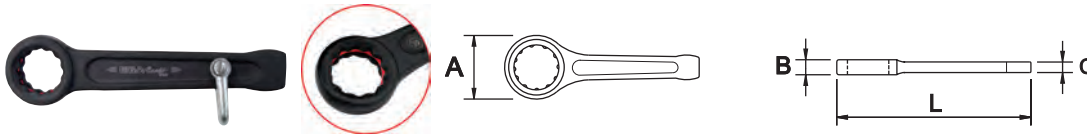

MM

COD.	AF mm	L (mm)	A (mm)	B (mm)	C (mm)	Kg	
AD574257	22	155	38	13	8		
AD574267	23						
AD574277	24	165	42	14	8,5	0,2	
AD574287	25						
AD574297	26						
AD562957	27	175	46		9,5	0,3	
AD574307	28						
AD574317	29		50	16		0,4	
AD562967	30	185					
AD574327	31						
AD574337	32		55		11	0,5	5
AD574347	33			18			
AD574357	34	210					
AD574367	35			19		0,6	
AD574377	36		60				
AD574387	37	220					
AD574397	38			20	12	0,7	
AD574407	41	225	65				
AD574417	42						
AD574427	45						
AD574437	46	240	75	22	13	1	
AD574447	47						
AD574457	48						
AD574467	50	250	80	23		1,2	
AD574477	52				14		
AD574487	54						
AD574497	55		85	24		1,4	
AD574507	56						
AD574517	58	270					
AD574527	59						
AD574537	60		90	26	15	1,6	
AD574547	61						
AD574557	62						
AD574567	63						
AD574577	64	300	100	30	16	1,9	1
AD562977	65						
AD574587	66						
AD574597	67						
AD574607	68						
AD574617	69	320	110	32	17	2,3	
AD574627	70						
AD574047	71						
AD574057	72						
AD574067	73						
AD574077	74	330	115	33	18	2,9	
AD574087	75						
AD585817	80	350	125	34	19	3,6	
AD585827	85	360	130	36	20	3,9	
AD585837	90	380	135	39	23	5,0	
AD585847	95	390	140				

COD.	AF mm	L (mm)	A (mm)	B (mm)	C (mm)	Kg	
AD585857	100	410	150			6,0	
AD585867	105	420	155	43	25	6,5	1
AD585877	110		165			8,0	
AD585887	115	450	170	45	28	9,5	

INCH

COD.	AF inch	L (mm)	A (mm)	B (mm)	C (mm)	Kg	
AD574657	7/8	155	38	13	8		
AD574667	15/16	165	42	14	9	0,2	
AD574677	1	175	46		10	0,3	
AD574687	1.1/16						
AD574697	1.1/8		50	16		0,4	
AD574707	1.3/16	185					
AD574717	1.1/4		55		11		
AD574727	1.5/16			18		0,5	5
AD574737	1.3/8	210		19			
AD574747	1.7/16		60				
AD574757	1.1/2	220					
AD574767	1.9/16						
AD574777	1.5/8	230	65	20	12	0,7	
AD574787	1.11/16						
AD574797	1.3/4						
AD574807	1.13/16	240	75	22	13		
AD574817	1.7/8					1	
AD574827	1.15/16						
AD574837	2	250	80	23			
AD574847	2.1/16				14		
AD574857	2.1/8		85	24		1,4	
AD574867	2.3/16						
AD574877	2.1/4	270					
AD574887	2.5/16						
AD574897	2.3/8		90	26	15	1,6	1
AD574907	2.7/16						
AD574917	2.1/2						
AD574927	2.9/16	300	100	28	16	2,3	
AD574937	2.5/8						
AD574947	2.11/16						
AD574957	2.3/4	320	110	32	17	2,5	



■ **ACCESORIOS / ACCESSORIES / ACCESSOIRES / ERSATZTEILE / ACCESSORI / ACESSORIOS / ЗАПАСНЫЕ ЧАСТИ**

■ **MM**

COD.	Descripción / Description / Description	Válido para / Valid for / Valable pour
89129		AD574257
89130		AD574267
89131		AD574277
89132		AD574287
89133		AD574297
89134		AD562957
89135		AD574307
89136		AD574317
89137		AD562967
89138		AD574327
89139		AD574337
89140		AD574347
89141		AD574357
89142		AD574367
89143		AD574377
89144		AD574387
89145		AD574397
89148		AD574407
89149		AD574417
89152		AD574427
89153		AD574437
89154		AD574447
89155		AD574457
89157		AD574467
89159		AD574477
89161		AD574487
89162	Set 5 pcs hilo tórico / Set of 5 o-ring cords / Jeu de 5 pcs corde	AD574497
89163		AD574507
89165		AD574517
89166		AD574527
89167		AD574537
89168		AD574547
89169		AD574557
89170		AD574567
89171		AD574577
89172		AD562977
89173	AD574587	
89174	AD574597	
89175	AD574607	
89176	AD574617	
89177	AD574627	
89178	AD574047	
89179	AD574057	
89180	AD574067	
89181	AD574077	
89182	AD574087	
89220	AD585817	
89221	AD585827	
89222	AD585837	
89223	AD585847	
89224	AD585857	
89225	AD585867	
89256	AD585877	
89257	AD585887	



■ **INCH**

COD.	Descripción / Description / Description	Válido para / Valid for / Valable pour
89187		AD574657
89188		AD574667
89189		AD574677
89190		AD574687
89191		AD574697
89192		AD574707
89193		AD574717
89194		AD574727
89195		AD574737
89197		AD574747
89198		AD574757
89199		AD574767
89200		AD574777
89201		AD574787
89202	Set 5 pcs hilo tórico / Set of 5 o-ring cords / Jeu de 5 pcs corde	AD574797
89203		AD574807
89204		AD574817
89205		AD574827
89206		AD574837
89207		AD574847
89208		AD574857
89209		AD574867
89211	AD574877	
89212	AD574887	
89213	AD574897	
89214	AD574907	
89215	AD574917	
89216	AD574927	
89217	AD574937	
89218	AD574947	
89219	AD574957	



■ **MM / INCH**

COD.	Descripción / Description / Description
89021	
89022	
89023	
89016	Grillete / Shackle / Manille
89017	
89018	



• Para más información de dimensiones y características del producto, consultar en el capítulo correspondiente del catálogo general o en [www.egamaster.com](http://www.egamaster.com). / For more details about features and dimensions of the products, check the corresponding chapter of the General Catalogue or [www.egamaster.com](http://www.egamaster.com). / Pour plus d'informations sur les dimensions et les caractéristiques du produit, consulter le chapitre correspondant de notre catalogue général ou sur [www.egamaster.com](http://www.egamaster.com).



LLAVES DE GOLPE SEGURIDAD TOTAL ANTICHISPA / NON SPARKING TOTAL SAFETY SLOGGING WRENCHES / CLÉS À FRAPPER SÉCURITÉ ASSURÉE  
 ANTIDÉFLAGRANT / SCHLAGRINGSCHLÜSSEL MIT SICHERUNG FUNKENFREI / CHIAVI A BATTERE SICUREZZA TOTALE ANTISCINTILLA / CHAVES DE LUNETASÉRIE  
 PANCADA DE SEGURANÇA TOTAL ANTI-CHISPA / КОЛЬЦЕВОЙ ИСКРОБЕЗОПАСНЫЙ УДАРНЫЙ КЛЮЧ-ЗВЕЗДОЧКА С ПОДВЕСОМ



MM

COD.	AF mm	L (mm)	A (mm)	B (mm)	C (mm)	Kg
AD360987	22					
AD360997	24	165	42	14	8,5	0,2
AD361007	25					
AD361017	26					
AD360747	27	175	46		9,5	0,3
AD361027	28					
AD361037	29			16		
AD360757	30					0,4
AD361047	31	185	53		10,5	
AD360767	32					
AD361057	33					0,5
AD361067	34					
AD361077	35	200	58	19	11	0,6
AD360777	36					
AD361087	37					
AD361097	38					
AD361107	39					
AD361117	40	220	64	20	12	0,7
AD361127	41					
AD361137	42					
AD361147	43					
AD361157	44	230				0,8
AD361167	45		73	22	13	
AD361177	46					
AD361187	47	240				0,9
AD361197	48					
AD361207	49					
AD361217	50		78	23	13,5	1
AD361227	51	250				1,1
AD361237	52					
AD361247	53					
AD361257	54					1,3
AD361267	55	260	86	23,5	14	
AD361277	56					
AD361287	57					
AD361297	58					1,4
AD361307	59					
AD361317	60	270	92	25,5	15	
AD361327	61					
AD361337	62					1,5
AD361347	63					
AD361357	64					
AD361367	65	300	102	28	16	1,8
AD361377	66					
AD361387	67					
AD361397	68					
AD361407	69	320	108	31,5	17	2,2
AD361417	70					
AD361427	71					

COD.	AF mm	L (mm)	A (mm)	B (mm)	C (mm)	Kg
AD361437	72	320	108	31,5	17	2,2
AD361447	73					
AD361457	74	330	113	33	18	2,7
AD361467	75					2,9

CARACTERÍSTICAS / FEATURES / CARACTÉRISTIQUES

Cu-Be

INCH

COD.	AF inch	L (mm)	A (mm)	B (mm)	C (mm)	Kg
AD361507	7/8					
AD361517	15/16	165	42	14	8,5	0,4
AD361527	1	175	46		9,5	
AD361537	1.1/16				10,5	
AD361547	1.1/8			16	10,6	0,5
AD361557	1.3/16	185	53		10,7	
AD361567	1.1/4				10,8	
AD361577	1.5/16					
AD361587	1.3/8					
AD361597	1.13/32	200	58	19	11	0,6
AD361607	1.7/16					
AD361617	1.1/2					
AD361627	1.9/16					
AD361637	1.5/8	220	64	20	12	0,7
AD361647	1.11/16					
AD361657	1.3/4					
AD361667	1.13/16	230	73	22	13	0,8
AD361677	1.7/8					
AD361687	1.15/16	250				
AD361697	2					
AD361707	2.1/16					
AD361717	2.1/8	260	78	23	13,5	
AD361727	2.3/16					1,3
AD361737	2.13/64					
AD361747	2.1/4	270				
AD361757	2.5/16		92	25,5	15	
AD361767	2.3/8					
AD361777	2.7/16	280				1,4
AD361787	2.1/2					
AD361797	2.9/16	300	102	30	16	
AD361807	2.5/8					1,5
AD361817	2.3/4	320	108	31,5	17	2,3

CARACTERÍSTICAS / FEATURES / CARACTÉRISTIQUES

Cu-Be





■ **ACCESORIOS / ACCESSORIES / ACCESSOIRES / ERSATZTEILE / ACCESSORI / ACESSORIOS / ЗАПАСНЫЕ ЧАСТИ**

■ **MM**

COD.	Descripción / Description / Description	Válido para / Valid for / Valable pour
89129		AD360987
89131		AD360997
89132		AD361007
89133		AD361017
89134		AD360747
89135		AD361027
89136		AD361037
89137		AD360757
89138		AD361047
89139		AD360767
89140		AD361057
89141		AD361067
89142		AD361077
89143		AD360777
89144		AD361087
89145		AD361097
89146		AD361107
89147		AD361117
89148		AD361127
89149		AD361137
89150		AD361147
89151		AD361157
89152		AD361167
89153		AD361177
89154		AD361187
89155	Set 5 pcs hilo tórico / Set of 5 o-ring cords / Jeu de 5 pcs corde	AD361197
89156		AD361207
89157		AD361217
89158		AD361227
89159		AD361237
89160		AD361247
89161		AD361257
89162		AD361267
89163		AD361277
89164		AD361287
89165		AD361297
89166		AD361307
89167		AD361317
89168		AD361277
89169		AD361337
89170		AD361347
89171		AD361357
89172		AD361367
89173		AD361377
89174		AD361387
89175		AD361397
89176		AD361407
89177		AD361417
89178		AD361427
89179		AD361437
89180		AD361447
89181		AD361457
89182		AD361467



■ **INCH**

COD.	Descripción / Description / Description	Válido para / Valid for / Valable pour
89187		AD361507
89188		AD361517
89189		AD361527
89190		AD361537
89191		AD361547
89192		AD361557
89193		AD361567
89194		AD361577
89195		AD361587
89196		AD361597
89197		AD361607
89198		AD361617
89199		AD361627
89200		AD361637
89201	Set 5 pcs hilo tórico / Set of 5 o-ring cords / Jeu de 5 pcs corde	AD361647
89202		AD361657
89203		AD361667
89204		AD361677
89205		AD361687
89206		AD361697
89207		AD361707
89208		AD361717
89209		AD361727
89210		AD361737
89211		AD361747
89212		AD361757
89213		AD361767
89214		AD361777
89215		AD361787
89216		AD361797
89217		AD361807
89219		AD361817



■ **MM / INCH**

COD.	Descripción / Description / Description
36191	
36192	Grillete / Shackle / Manille
36193	



• Para más información de dimensiones y características del producto, consultar en el capítulo correspondiente del catálogo general o en [www.egamaster.com](http://www.egamaster.com). / For more details about features and dimensions of the products, check the corresponding chapter of the General Catalogue or [www.egamaster.com](http://www.egamaster.com). / Pour plus d'informations sur les dimensions et les caractéristiques du produit, consulter le chapitre correspondant de notre catalogue général ou sur [www.egamaster.com](http://www.egamaster.com).



■ LLAVES FIJAS / OPEN-END WRENCHES / CLÉS À FOURCHE / GABELSCHLÜSSEL / CHIAVI FISSE / CHAVES DUAS BOCAS / РОЖКОВЫЕ КЛЮЧИ

■ INCH



COD.	AF inch
AD603007	1/4-5/16
AD603017	5/16-3/8
AD679417	5/16-11/32
AD603027	3/8-7/16
AD679427	7/16-1/2
AD603037	1/2-9/16
AD603047	9/16-5/8
AD603057	19/32-11/16
AD603067	5/8-11/16
AD679437	5/8-3/4
AD603077	11/16-3/4
AD603087	3/4-25/32
AD603097	3/4-7/8
AD603107	13/16-7/8
AD679447	7/8-15/16
AD603117	15/16-1
AD679457	15/16-1.1/8
AD603127	1-1.1/8
AD603137	1.1/16-1.1/8
AD603147	1.1/16-1.1/4

DIN 3110

CARACTERÍSTICAS / FEATURES / CARACTÉRISTIQUES

Cr-V

Cromado pulido espejo / Mirror polished chrome plating / Polie chromée

■ MM



COD.	AF mm
AD617017	6-7
AD629287	7-8
AD617027	8-9
AD679087	8-10
AD617037	10-11
AD626297	10-13
AD679097	11-13
AD617047	12-13
AD679107	12-14
AD679117	13-14
AD679127	13-15
AD679137	13-16
AD617057	14-15
AD679147	13-17
AD629307	14-17
AD617067	16-17
AD679157	16-18
AD617007	17-19
AD617077	18-19
AD679167	18-21
AD629317	19-22
AD617087	20-22
AD617097	21-23
AD639617	21-24
AD679177	22-24
AD617107	24-26
AD616527	24-27
AD617117	25-28
AD617127	27-29
AD679187	27-30
AD679197	27-32
AD617137	30-32

DIN 3110

CARACTERÍSTICAS / FEATURES / CARACTÉRISTIQUES

Cr-V

Cromado aeroespacial / Aerospaceal chrome plating / Chromée aérospatiale

EGA Master  
 ART IN INNOVATION



LLAVES COMBINADAS / COMBINATION WRENCHES / CLÉS MIXTES / RINGGABELSCHLÜSSEL / CHIAVI COMBinate / CHAVES BOCA E LUNETA / КОМБИНИРОВАННЫЕ КЛЮЧИ

INCH



COD.	AP inch
AD603407	1/4
AD603417	5/16
AD678787	11/32
AD603427	3/8
AD603437	7/16
AD603447	1/2
AD603457	9/16
AD603467	19/32
AD603477	5/8
AD603487	11/16
AD603497	3/4
AD603507	25/32
AD603517	13/16
AD603527	7/8
AD603537	15/16
AD603547	1
AD603557	1.1/16
AD603567	1.1/8
AD603577	1.3/16
AD603587	1.1/4
AD609577	1.5/16
AD609587	1.3/8
AD609617	1.7/16
AD609597	1.1/2
AD609627	1.5/8
AD608977	1.3/4
AD608987	1.13/16
AD608997	1.7/8
AD609607	2

DIN 3113

CARACTERÍSTICAS / FEATURES / CARACTÉRISTIQUES

Cr-V

Cromado pulido espejo / Mirror polished chrome plating / Polie chromée

MM



COD.	AP mm
AD617257	6
AD617267	7
AD617277	8
AD617287	9
AD617297	10
AD617307	11
AD617317	12
AD617327	13
AD617337	14
AD617347	15
AD617357	16
AD617367	17
AD617377	18
AD617387	19
AD617397	20
AD617407	21
AD617417	22
AD617427	23
AD617437	24
AD617447	25
AD617457	26
AD617467	27
AD617477	28
AD617487	29
AD617497	30
AD617507	32

DIN 3113

CARACTERÍSTICAS / FEATURES / CARACTÉRISTIQUES

Cr-V

Cromado aeroespacial / Aerospaceal chrome plating / Chromée aérospatiale



LLAVES ACODADAS / DOUBLE OFFSET RING WRENCHES / CLÉS POLYGALES / RINGSCHLÜSSEL / CHIAVI POLIGONALI / CHAVES LUNETA / КЛЮЧИ ДВОЙНАЯ ИЗОГНУТАЯ ЗВЕЗДОЧКА

INCH

COD.	AF inch
AD603807	1/4-5/16
AD678867	5/16-11/32
AD603817	5/16-3/8
AD603827	3/8-7/16
AD678877	7/16-1/2
AD603837	1/2-9/16
AD603847	9/16-5/8
AD603857	19/32-11/16
AD603867	5/8-11/16
AD678887	5/8-3/4
AD603877	11/16-3/4
AD678897	11/16-13/16
AD603887	3/4-25/32
AD603897	3/4-7/8
AD678907	3/4-13/16
AD603907	13/16-7/8
AD678917	7/8-15/16
AD678927	7/8-1.1/16
AD603917	15/16-1
AD678937	1-1.1/16
AD603927	1-1.1/8
AD603937	1.1/16-1.1/8
AD603947	1.1/16-1.1/4
AD678947	1.1/8-1.1/4

DIN 838

CARACTERÍSTICAS / FEATURES / CARACTÉRISTIQUES

Cr-V

Cromado pulido espejo / Mirror polished chrome plating / Polie chromée



MM

COD.	AF mm
AD617757	6-7
AD678437	7-8
AD617767	8-9
AD678447	8-10
AD617777	10-11
AD678457	10-12
AD678467	10-13
AD678477	11-13
AD678487	11-14
AD617787	12-13
AD678497	12-14
AD678507	13-14
AD617797	14-15
AD678517	13-16
AD678527	13-17
AD678537	14-17
AD617807	16-17
AD678547	16-18
AD678557	17-19
AD617817	18-19
AD678567	18-21
AD678577	19-22
AD617827	20-22
AD617837	21-23
AD678587	21-24
AD678597	22-24
AD617847	24-26
AD617887	24-27
AD617857	25-28
AD617867	27-29
AD678607	27-30
AD617877	30-32

DIN 838

CARACTERÍSTICAS / FEATURES / CARACTÉRISTIQUES

Cr-V

Cromado aeroespacial / Aerospaceal chrome plating / Chromée aérospatiale



BE SAFE...BE EFFICIENT



■ DESTORNILLADORES / SCREWDRIVERS / TOURNEVIS / SCHRAUBENZIEHER / CACCIAVITI / CHAVES DE FENDA / ОТВЕРТКИ

■ MASTERTORK

■ MECÁNICO / SLOTTED / MECANICIEN / FÜR SCHLITZSCHRAUBEN / PER MECCANICI / MECÂNICO / ПЛОСКАЯ

■ MM



COD.	mm	mm
AD664007	3	80
AD664017	4	100
AD664027	5,5	
AD664037		125
AD664047	6,5	
AD664057		150
AD664067	8	
AD664077		200
AD664487	9,5	
AD664087	10	
AD664097	12	
AD664497	13	250
AD664107	14	

■ DIN 5265

■ MM



COD.	mm	mm
AD664137	4	100
AD664147	5,5	
AD664157		125
AD664167	8	
AD664177	10	200
AD664187	12	
AD664197	14	250

■ DIN 5265

CARACTERÍSTICAS / FEATURES / CARACTÉRISTIQUES

Hexagonal / Hexagonal / Hexagonale

■ INCH



COD.	inch	inch
AD553307	1/8	3
AD553317	5/32	
AD553327		4
AD553337	7/32	
AD553347		5
AD553357	1/4	
AD553367		6
AD553377	5/16	
AD553387	3/8	
AD553397	25/64	
AD553407	15/32	
AD553417	1/2	10

■ DIN 5265

■ INCH



COD.	inch	inch
AD553447	5/32	4
AD553457	7/32	
AD553467	1/4	
AD553477	5/16	6
AD553487	25/64	
AD553497	15/32	10

■ DIN 5265

CARACTERÍSTICAS / FEATURES / CARACTÉRISTIQUES

Hexagonal / Hexagonal / Hexagonale



ELECTRICISTA / ELECTRICIAN / ELECTRICIEN / ELEKTRIK / PER ELETRICISTI / ELETRICISTA / ЭЛЕКТРИЧЕСКАЯ

MM



COD.	mm	mm
AD664207	2,5	75
AD664217		60
AD664227	3	100
AD664237		125
AD664247	4	150
AD664117		300
AD664257		150
AD664127	5,5	300
AD664267	6,5	150
AD664277	8,0	175

DIN 5265

INCH



COD.	inch	inch
AD553527	3/32	3
AD553547	1/8	4
AD553557		5
AD553567	5/32	6
AD553577		12
AD553587		6
AD553597	7/32	12
AD553607	1/4	6
AD553617	5/16	7

DIN 5265

PHILIPS



COD.	mm	mm
AD664387	PH-0	60
AD664397	PH-1	100
AD664377		300
AD664407		125
AD664437	PH-2	300
AD664417	PH-3	150
AD664427	PH-4	200

DIN 5262



COD.	mm	mm
AD664447	PH-1	100
AD664457	PH-2	125
AD664467	PH-3	150
AD664477	PH-4	200

DIN 5262

CARACTERÍSTICAS / FEATURES / CARACTÉRISTIQUES

Hexagonal / Hexagonal / Hexagonale

POZIDRIV®\*



COD.	mm	mm
AD664567	PZ-0	60
AD664577	PZ-1	100
AD664727		300
AD664587		125
AD664737	PZ-2	300
AD664597	PZ-3	150
AD664607	PZ-4	200

DIN 5262



COD.	mm	mm
AD664627	PZ-1	100
AD664637	PZ-2	125
AD664647	PZ-3	150
AD664657	PZ-4	200

DIN 5262

CARACTERÍSTICAS / FEATURES / CARACTÉRISTIQUES

Hexagonal / Hexagonal / Hexagonale

\*Para tornillos POZIDRIV® (Marca registrada por European Ind. Serv. Ltd.) / \*For screws POZIDRIV® (European Ind. Serv. Ltd. registered trademark) / \*Pour vis POZIDRIV® (Marque enregistrée par European Ind. Serv. Ltd.)



### TORX®\*



COD.		
AD664747	T-6	50
AD664757	T-7	
AD664767	T-8	
AD664777	T-9	75
AD664787	T-10	
AD664797	T-15	
AD664807	T-20	100
AD664817	T-25	
AD664827	T-27	
AD664837	T-30	125
AD664847	T-40	
AD664857	T-45	
AD664867	T-50	175

DIN 5262

### TAMPER TORX



COD.		
AD664877	TT-6	50
AD664887	TT-7	
AD664897	TT-8	
AD664907	TT-9	75
AD664917	TT-10	
AD664927	TT-15	
AD664937	TT-20	100
AD664947	TT-25	
AD664957	TT-27	
AD664967	TT-30	125
AD664977	TT-40	
AD664987	TT-45	
AD664997	TT-50	175

### PUNTA ESFERA / BALL TIP / TÊTE SPHÉRIQUE / KUGELKOPF / TESTA SFERICA / PONTA ESFERICA / С ШАРОВОЙ ГОЛОВКОЙ

#### MM



COD.		
AD665017	2,5	75
AD665027	3	
AD665037	4	



#### INCH



COD.		
AD553647	1/8	3
AD553657	5/32	4
AD553687	5/16	6
AD553697	25/64	



### ROBERTSON



COD.		
AD665307	1	100
AD665317	2	125
AD665327	3	150



\* Para más información de dimensiones y características del producto, consultar en el capítulo correspondiente del catálogo general o en [www.egamaster.com](http://www.egamaster.com). / For more details about features and dimensions of the products, check the corresponding chapter of the General Catalogue or [www.egamaster.com](http://www.egamaster.com). / Pour plus d'informations sur les dimensions et les caractéristiques du produit, consulter le chapitre correspondant de notre catalogue général ou sur [www.egamaster.com](http://www.egamaster.com).

\*Para tornillos TORX® (Marca registrada por Acument Intellectual Properties, LLC, Troy, Mich., US) / \*For screws TORX® (Acument Intellectual Properties, LLC, Troy, Mich., US registered trademark) / \*Pour vis TORX® (Marque enregistrée par Acument Intellectual Properties, LLC, Troy, Mich., US)





■ **CARROCERO / STUBBY / TOM POUCE / SCHRAUBENDREHER, KURZE FORM / CACCIAVITI NANI / COTOS / КОРОТКАЯ**

■ **ELECTRICISTA / ELECTRICIAN / ELECTRICIEN / ELEKTRIK / PER ELETTRICISTI / ELETRICISTA / ЭЛЕКТРИЧЕСКАЯ**

■ **MM**





COD.		
<b>AD665257</b>	5,5	25

● | DIN 5265

■ **INCH**



COD.		
<b>AD553717</b>	7/32	1

● | DIN 5265

■ **PHILIPS**



COD.		
<b>AD671927</b>	PH-1	25
<b>AD665267</b>	PH-2	

● | DIN 5262

■ **POZIDRIV®\***





COD.		
<b>AD671937</b>	PZ-1	25
<b>AD665277</b>	PZ-2	

● | DIN 5262

■ **DE VASO / SOCKET SCREWDRIVER / CLÉ À DOUILLE EMMANCHÉE / 6-KANT STECKSCHLÜSSEL / BUSSOLE / DE CAIXA / ОТВЕРТКА С ГОЛОВКОЙ**



■ **MM**



COD.		
<b>AD665107</b>	4	150
<b>AD665117</b>	5	
<b>AD665127</b>	5,5	
<b>AD665137</b>	6	
<b>AD665147</b>	7	
<b>AD665157</b>	8	
<b>AD665167</b>	9	
<b>AD665177</b>	10	
<b>AD665187</b>	11	
<b>AD665197</b>	12	
<b>AD665207</b>	13	175
<b>AD665217</b>	14	

■ **INCH**



COD.		
<b>AD553737</b>	5/32	6
<b>AD553747</b>	3/16	
<b>AD553757</b>	7/32	
<b>AD553767</b>	1/4	
<b>AD553787</b>	5/16	
<b>AD553797</b>	11/32	
<b>AD553807</b>	25/64	
<b>AD553827</b>	15/32	7
<b>AD553837</b>	1/2	

●

\*Para tornillos POZIDRIV® (Marca registrada por European Ind. Serv. Ltd.) / \*For screws POZIDRIV® (European Ind. Serv. Ltd. registered trademark) / \*Pour vis POZIDRIV® (Marque enregistrée par European Ind. Serv. Ltd.)







■ MICROTRONIC

■ ELECTRICISTA / ELECTRICIAN / ELECTRICIEN / ELEKTRIK / PER ELETTRONICA / ELETRICISTA / ЭЛЕКТРИЧЕСКАЯ

■ MM





COD.		
AD668467	2	50
AD668487	3	75

DIN 6265

■ PHILIPS



COD.		
AD668507	PH-00	50
AD668517	PH-0	
AD668527	PH-1	75

DIN 6262

■ LIMAS, ESCOFINAS, BOTADORES Y GRANETES / FILES, RASPS & PUNCHES / LIMES, RAPES, POINTEAUX ET CHASSES GOUPILLES / FEILEN, RASPELN, DURCHSCHLÄGER UND KÖRNER / LIMA, RASPE E PUNZONI / LIMAS, GROSAS E PUNÇÕES / НАПИЛЬНИКИ, РАШПИЛИ, МЕТЧИКИ

■ STANDARD

■ LIMAS PLANAS PARALELAS / HAND FILES / LIMES PLATES PARALLELES / FLACHSTUMPF / LIMA PIATTA PARALLELA / LIMAS PARALELAS / РУЧНЫЕ НАПИЛЬНИКИ



COD.	L (inch)	
AD634917		1
AD634927	4	2
AD634937		3
AD634947		1
AD634957	6	2
AD634967		3
AD634977		1
AD634987	8	2
AD634997		3
AD635007		1
AD635017	10	2
AD635027		3
AD635037		1
AD635047	12	2
AD635057		3
AD635067		1
AD635077	14	2
AD635087		3

1: Basta / Bastard / Batarde  
 2: Entrefina / Medium / Demi douce  
 3: Fina / Smooth / Douce

■ LIMAS PLANAS DE PUNTA / FLAT FILES / LIMES PLATES DE BOUT / FLACHSPITZ / LIMA PIATTA A PUNTA / LIMAS CHATAS / ПЛОСКИЕ НАПИЛЬНИКИ



COD.	L (inch)	
AD635277		1
AD635287	4	2
AD635297		3
AD635307		1
AD635317	6	2
AD635327		3
AD635337		1
AD635347	8	2
AD635357		3
AD635367		1
AD635377	10	2
AD635387		3
AD635397		1
AD635407	12	2
AD635417		3
AD635427		1
AD635437	14	2
AD635447		3

1: Basta / Bastard / Batarde  
 2: Entrefina / Medium / Demi douce  
 3: Fina / Smooth / Douce



**LIMAS MEDIA CAÑA / HALF ROUND FILES / LIMES DEMI-RONDES / HALBRUND-  
FEILEN, SPITZE FORM / LIMA MEZZATONDA / LIMAS MEIA CANA / ПОЛУКРУГЛЫЕ  
НАПИЛЬНИКИ**



COD.	L (inch)	
AD635637		1
AD635647	4	2
AD635657		3
AD635667		1
AD635677	6	2
AD635687		3
AD635697		1
AD635707	8	2
AD635717		3
AD635727		1
AD635737	10	2
AD635747		3
AD635757		1
AD635767	12	2
AD635777		3
AD635787		1
AD635797	14	2
AD635807		3

1: Basta / Bastard / Batarde  
2: Entrefina / Medium / Demi douce  
3: Fina / Smooth / Douce

**LIMAS TRIANGULARES / TRIANGULAR FILES / LIMES TRIANGULAIRES /  
DREIKANTFEILEN / LIMA TRIANGOLARE / LIMATÕES TRIANGULARES / ТРЕУГОЛЬНЫЕ  
НАПИЛЬНИКИ**



COD.	L (inch)	
AD635997		1
AD636007	4	2
AD636017		3
AD636027		1
AD636037	6	2
AD636047		3
AD636057		1
AD636067	8	2
AD636077		3
AD636087		1
AD636097	10	2
AD636107		3
AD636117		1
AD636127	12	2
AD636137		3
AD636147		1
AD636157	14	2
AD636167		3

1: Basta / Bastard / Batarde  
2: Entrefina / Medium / Demi douce  
3: Fina / Smooth / Douce

**LIMAS CUADRADAS / SQUARE FILES / LIMES CARRÉES / VIERKANTFEILEN / LIMA  
QUADRA / LIMATÕES QUADRADOS / КВАДРАТНЫЕ НАПИЛЬНИКИ**



COD.	L (inch)	
AD636357		1
AD636367	4	2
AD636377		3
AD636387		1
AD636397	6	2
AD636407		3
AD636417		1
AD636427	8	2
AD636437		3
AD636447		1
AD636457	10	2
AD636467		3
AD636477		1
AD636487	12	2
AD636497		3
AD636507		1
AD636517	14	2
AD636527		3

1: Basta / Bastard / Batarde  
2: Entrefina / Medium / Demi douce  
3: Fina / Smooth / Douce

**LIMAS REDONDAS / ROUND FILES / LIMES RONDES / RUNDFEILEN / LIMA TONDA /  
LIMATÕES REDONDOS / КРУГЛЫЕ НАПИЛЬНИКИ**



COD.	L (inch)	
AD636717		1
AD636727	4	2
AD636737		3
AD636747		1
AD636757	6	2
AD636767		3
AD636777		1
AD636787	8	2
AD636797		3
AD636807		1
AD636817	10	2
AD636827		3
AD636837		1
AD636847	12	2
AD636857		3
AD636867		1
AD636877	14	2
AD636887		3

1: Basta / Bastard / Batarde  
2: Entrefina / Medium / Demi douce  
3: Fina / Smooth / Douce



**LIMAS AFILADO / SHARPENING FILES / LIMES AIGUILLES / PRÄZISIONSNADELFEILEN DÜNN / LIMA AFFILATA / LIMAS DE AFIAR, DE AGRICULTOR / ЗАТАЧИВАЮЩИЕ НАПИЛЬНИКИ**

**LIMA TRIANGULAR DELGADA / SLIM TAPER SAW / LIME TRIANGULAIRE ETROITE / PRÄZISIONSNADELFEILEN DÜNN / LIMA TRIANGOLARE / LIMAS TRIANGULARES FINAS / ТРЕУГОЛЬНЫЙ НАПИЛЬНИК**



COD.	L (inch)	
AD636927	4	4
AD636937	5	

4: Extrafina / Very smooth / Extrafine

**LIMA TRIANGULAR EXTRA-DELGADA / EXTRA REGULAR TAPER SAW / LIME EXTRA FINE / DREIKANTFEILEN / LIMA TRIANGOLARE EXTRA-SOTTILE / LIMAS TRIANGULARES EXTRA-FINAS / МЕЛКИЙ ТРЕУГОЛЬНЫЙ НАПИЛЬНИК**



COD.	L (inch)	
AD636967	4	4
AD636977	5	

4: Extrafina / Very smooth / Extrafine

**ESCOFINAS / RASPS / RAPES / SCHABER / RASPA / GROSAS / РАШПИЛИ**

**ESCOFINAS PLANAS PARALELAS / HAND WOOD RASPS / RÂPES PLATES PARALLELES / FLACH RAPS / RASPA PIATTA PARALLELA / GROSAS PARALELAS / РУЧНЫЕ РАШПИЛИ ПО ДЕРЕВУ**



COD.	L (inch)	mm/cm
AD637007	10	3
AD637017	12	

**ESCOFINAS REDONDAS / ROUND RASPS / RAPES RONDES / RUNDE RAPS / RASPA TONDA / GROSAS REDONDAS / КРУГЛЫЕ РАШПИЛИ**



COD.	L (inch)	mm/cm
AD637127	8	3
AD637137	10	

**ESCOFINAS MEDIA CAÑA / HALF ROUND RASPS / RÂPES DEMI-RONDES / HALBRUND RAPS / RASPA MEZZOTANDA / GROSAS MEIA CANA / ПОЛУКРУГЛЫЙ РАШПИЛЬ**



COD.	L (inch)	mm/cm
AD637067	6	
AD637077	8	
AD637087	10	3
AD637097	12	



■ **HERRAMIENTA PARA TUBO / PIPE TOOLS / OUTILLAGE TUBE / ROHR WERKZEUGE / FERRAMENTI PER TUBI / FERRAMENTA PARA TUBOS / ТРУБНЫЙ ИНСТРУМЕНТ**

■ **LLAVES PARA TUBO / PIPE WRENCHES / CLÉS SERRE-TUBES / EINHAND ROHRZANGE / CHIAVE GIRATUBI / CHAVES PARA TUBOS / ТРУБНЫЕ КЛЮЧИ**

■ **MASTERGRIP**



COD.	L (inch)
AD614057	10
AD614067	14



■ **LLAVES STILLSON / STILLSON PIPE WRENCHES / CLÉS STILLSON / STILLSON ROHRZANGE / GIRATUBI MODELLO STILLSON / CHAVES STILLSON / ТРУБНЫЕ КЛЮЧИ STILLSON**

■ **REFORZADA / REINFORCED / RENFORCEE / VERSTARK / RINFORZATA / REFORÇADA / УСИЛЕННЫЕ**



COD.	L (inch)
AD610017	8
AD610027	10
AD610037	12
AD610047	14

UNE 16552 / BS 3594-1 / GGG-W-00651d

■ **LLAVE HEAVY DUTY / HEAVY DUTY PIPE WRENCH / CLÉ SERRE-TUBES HEAVY DUTY / HEAVY DUTY ROHRZANGE / GIRATUBI MODELLO AMERICANO PESANTE / CHAVE HEAVY DUTY / ТРУБНЫЕ КЛЮЧИ ДЛЯ БОЛЬШИХ НАГРУЗОК**



COD.	L (inch)
AD612997	6
AD610147	8
AD610157	10
AD610167	12
AD610177	14

GGG-W-651-E, Type II Class A

**CARACTERÍSTICAS / FEATURES / CARACTÉRISTIQUES**

Con pasador de seguridad / With safety pin / Avec goupille de fixation sécurisée

■ **LLAVE DE ALUMINIO / ALUMINIUM PIPE WRENCH / CLÉ SERRE-TUBES EN ALLIAGE LEGER / ALUMINIUM ROHRZANGE / GIRATUBI MODELLO AMERICANO IM ALLUMINIO / CHAVE ALUMINIO / АЛЮМИНИЕВЫЕ ТРУБНЫЕ КЛЮЧИ**

■ **TITALUM®**



COD.	L (inch)
AD610447	10
AD610237	12
AD610247	14
AD610267	24

TITALUM® | GGG-W-651-E, Type II Class C

**CARACTERÍSTICAS / FEATURES / CARACTÉRISTIQUES**

Con pasador de seguridad / With safety pin / Avec goupille de fixation sécurisée

■ **LLAVE SPUD / SPUD PIPE WRENCH / CLÉ SPUD / VERSTELLBARE ROHRZANGE / GIRATUBI MODELLO SPUD / CHAVE PARA TUBO SPUD / ТРУБНЫЙ КЛЮЧ С ПАРАЛЛЕЛЬНЫМИ ГУБКАМИ**



COD.	L (inch)
AD613697	12

**CARACTERÍSTICAS / FEATURES / CARACTÉRISTIQUES**

Con pasador de seguridad / With safety pin / Avec goupille de fixation sécurisée

■ **LLAVE HEXAGONAL / HEX PIPE WRENCH / CLÉ HEXAGONALE / SECHSKANT ROHRZANGE / GIRATUBI HEXAGONALE / CHAVE PARA TUBO HEXAGONAL / ТРУБНЫЙ КЛЮЧ ДЛЯ ШЕСТИГРАННИКОВ**



COD.	L (inch)
AD613687	14.1/2

**CARACTERÍSTICAS / FEATURES / CARACTÉRISTIQUES**

Con pasador de seguridad / With safety pin / Avec goupille de fixation sécurisée



**LLAVE HEXAGONAL CURVA / HEXAGONAL OFFSET PIPE WRENCH / CLÉ HEXAGONALE COUDÉE / GEKRÖPFTE ROHRZANGE / GIRATUBI HEXAGONALE CURVO / CHAVE HEXAGONAL INCLINADA / ИЗОГНУТЫЙ ТРУБНЫЙ КЛЮЧ ДЛЯ ШЕСТИГРАННИКОВ**



COD.	L (inch)
AD613677	9.1/2

**CARACTERÍSTICAS / FEATURES / CARACTÉRISTIQUES**

Con pasador de seguridad / With safety pin / Avec goupille de fixation sécurisée

**LLAVE DE CADENA REVERSIBLE / REVERSIBLE CHAIN PIPE WRENCH / CLÉ À CHAÎNE RÉVERSIBLE / KETTENROHRZANGE / CHIAVE A CATENA REVERSIBILE / CHAVE CORRENTE REVERSIVEL / РЕВЕРСИВНЫЙ ЦЕПНОЙ КЛЮЧ**



COD.	L (mm)	L (inch)
AD610357	300	12

**LLAVE DE CORREA / STRAP WRENCH / CLÉ À SANGLE / GURTRÖHRZANGE / GIRATUBI A NASTRO / CHAVE DE CORREIA / РЕМШКОВЫЙ КЛЮЧ**



COD.	CAP. (inch)
AD614807	3
AD614817	8
AD614827	12

**TENAZA GRIP MULTIPOSICIÓN DE GRAN CAPACIDAD / MULTIPOSITION LARGE CAPACITY GRIP PLIER / PINCE ÉTAU GRANDE CAPACITÉ, MULTIPositionS / GRIPZANGE FÜR GROSSE DURCHMESSER / PINZA AUTOBLOCCANTE A DOPPIA REGOLAZIONE / ALICATE DE GRIF MULTIPOSIÇÃO DE GRANDE CAPACIDADE / МНОГОПОЗИЦИОННЫЕ ЗАЖИМНЫЕ ЩИПЦЫ GRIP С БОЛЬШОЙ ЕМКОСТЬЮ**



COD.	L (inch)
AD620977	10

**CORTE / CUTTING / OUTILS COUPANTS / SCHNEIDWERKZEUG / ARCHETTI / CORTE / РЕЗКА**

**CORTADORES DE SEGURIDAD CON CUCHILLA AUTO-RETRÁCTIL / SAFETY CUTTER WITH AUTO-RETRACTABLE BLADE / CUTTER DE SÉCURITÉ AVEC LAME AUTO-RÉTRACTABLE / SICHERHEITSMESSER MIT AUTOMATISCH EINZIEHBARER KLINGE / TAGLIERINO DI SICUREZZA CON LAMA AUTOMATICA - RETRAIBILE / X-ACTOS DE SEGURANÇA COM LÂMINA AUTO-RETRACTIL / БЕЗОПАСНЫЙ НОЖ С АВТОМАТИЧЕСКИ УБИРАЕМЫМ ЛЕЗВИЕМ**



COD.	mm
AD638767	0,6



COD.	mm
AD638777	0,6



COD.	mm
AD638787	0,6

**ARCO DE SIERRA / HACK SAW / MONTURE DE SCIE À MÉTAUX / METALLSÄGEBOGEN / ARCHETTI / ARCOS DE SERRA / НОЖОВКА**

**KRONOS 0° & 45° & 90°**



COD.	inch	mm
AD637427	12	300



**CARACTERÍSTICAS / FEATURES / CARACTÉRISTIQUES**

Aluminio / Aluminum / Aluminium

**TIJERAS PARA CHAPA / TIN SNIPS / CISAILLES À TOLE / BLECHSCHEREN / CISOIE PER LAMIERA / TESOURA PARA CHAPA / НОЖИЦЫ ДЛЯ ЛИСТОВОГО МЕТАЛЛА**



COD.	L (inch)
AD622327	8
AD621597	10
AD622337	12
AD622347	14



**CINCEL MECÁNICO / FLAT COLD CHISEL / BURIN MÉCANICIEN / FLACHMEIBEL / SCALPELLO PER MECCANICO / ESCOPRO MECÂNICO / ПЛОСКОЕ ЗУБИЛО**



COD.	L x W (mm)
AD628537	250 x 25

**RASQUETA PARA JUNTAS / GASKET SCRAPER / GRATTOIR À JOINTS / DICHUNGSSCHABER / RASCHIETTO PER GIUNTI / RASCADOR PARA JUNTAS / СКРЕБОК ДЛЯ УДАЛЕНИЯ ПРОКЛАДОК**



COD.	L (mm)
AD671957	260

**MARTILLOS / HAMMERS / MARTEAUX / HÄMMER / MARTELLI / MARTELOS / МОЛОТКИ И КУВАЛДЫ**

**FIBRA DE VIDRIO / FIBERGLASS / FIBRE EN VERRE / FIBERGLASSTIEL / FIBRA DI VETRO / FIBRA DE VIDRO / ФИБЕРГЛАСС**

**MACETA MOD. ESPAÑOL / SPANISH TYPE STONING HAMMER / MASSETTE ESPAGNOLE / FÄUSTEL / MAZZETA MOD. SPAGNOLO / MARRETA MOD. ESPANHOL / КУВАЛДА ИСПАНСКИЙ ТИП ДЛЯ КАМНЯ**



COD.	Kg
AD696627	0,7
AD696637	1
AD696647	1,4

**CARACTERÍSTICAS / FEATURES / CARACTÉRISTIQUES**

Fibra de vidrio / Fiberglass / Fibre de verre

**MACETA CUADRADA TIPO ALEMÁN / GERMAN TYPE STONING HAMMER / MASSETTE TYPE ALLEMAND / FÄUSTEL / MAZZETA / MARRETA / КУВАЛДА НЕМЕЦКИЙ ТИП ДЛЯ КАМНЯ**



COD.	Kg
AD696667	0,8
AD696677	1
AD696687	1,25
AD696697	1,5

**CARACTERÍSTICAS / FEATURES / CARACTÉRISTIQUES**

Fibra de vidrio / Fiberglass / Fibre de verre

**MACETA MODELO INGLÉS / BRITISH TYPE STONING HAMMER / MASSETTE TYPE ANGLAIS / FÄUSTEL / MAZZETA MOD. INGLES / MARRETA MOD. INGLES / КУВАЛДА БРИТАНСКИЙ ТИП ДЛЯ КАМНЯ**



COD.	lb
AD696737	2,5
AD696747	3

**CARACTERÍSTICAS / FEATURES / CARACTÉRISTIQUES**

Fibra de vidrio / Fiberglass / Fibre de verre

**MARTILLO ALEMÁN / GERMAN TYPE MACHINIST'S HAMMER / MARTEAU DE MECANICIEN / SCHLOSSERHAMMER, DEUTSCHE FORM / MARTELLO TEDESCO / MARTELO TIPO ALEMÃO / СПЕСАРНЫЙ МОЛОТОК НЕМЕЦКИЙ ТИП**



COD.	g
AD697317	200
AD697327	300
AD697337	400
AD697347	500
AD697357	600
AD697367	800
AD697377	1000

**CARACTERÍSTICAS / FEATURES / CARACTÉRISTIQUES**

Fibra de vidrio / Fiberglass / Fibre de verre



MARTILLO DE EBANISTA / JOINER'S HAMMER / MARTEAU DE MENUISIER /  
 HOLZSCHNITZERHAMMER / MARTELLO FALEGNAME / MARTELO DE PENA /  
 СТОЛЯРНЫЙ МОЛОТОК



COD.	
AD696847	150
AD696857	200
AD696867	250
AD696877	350
AD696887	450
AD696897	550

CARACTERÍSTICAS / FEATURES / CARACTÉRISTIQUES

Fibra de vidrio / Fiberglass / Fibre de verre

MARTILLO RIVOIR / FRENCH TYPE MACHINIST'S HAMMER / MARTEAU RIVOIR /  
 RIVOIR HAMMER / MARTELLO RIVOIR / MARTELO PENA TIPO RIVOIR / СЛЕСАРНЫЙ  
 МОЛОТОК ФРАНЦУЗСКИЙ ТИП



COD.	
AD697387	250
AD697397	375
AD697407	675
AD697417	900
AD697567	1100

CARACTERÍSTICAS / FEATURES / CARACTÉRISTIQUES

Fibra de vidrio / Fiberglass / Fibre de verre

MARTILLO DE BOLA / BALL PEIN HAMMER / MARTEAU À BOULE /  
 SCHLOSSERHAMMER, ENGLISCHE FORM / MARTELLO A PALLA / MARTELO DE BOLA /  
 МОЛОТОК С ШАРОВОЙ ГОЛОВКОЙ



COD.	
AD697047	250
AD697057	350
AD697067	500
AD697077	700
AD697087	1000

CARACTERÍSTICAS / FEATURES / CARACTÉRISTIQUES

Fibra de vidrio / Fiberglass / Fibre de verre

MARTILLO DE ENCOFRADOR / SPANISH TYPE CLAW HAMMER / MARTEAU DE  
 COFFREUR / KLAUENHAMMER / MARTELLO CARPENTIERE / MARTELO DE COFRADOR /  
 МОЛОТОК-ГВОЗДОДЕР ИСПАНСКИЙ ТИП



COD.	
AD697157	300
AD697167	400
AD697177	500

CARACTERÍSTICAS / FEATURES / CARACTÉRISTIQUES

Fibra de vidrio / Fiberglass / Fibre de verre

MARTILLO DE UÑA / CLAW HAMMER / MARTEAU DE CHARPENTIER /  
 KLAUENHAMMER / MARTELLO CARPENTIERE / MARTELO DE UNHA / МОЛОТОК-  
 ГВОЗДОДЕР



COD.	
AD697197	550

CARACTERÍSTICAS / FEATURES / CARACTÉRISTIQUES

Fibra de vidrio / Fiberglass / Fibre de verre

MARTILLO DE UÑA MODELO AMERICANO / AMERICAN CLAW HAMMER / MARTEAU DE  
 CHARPENTIER MODÈLE AMÉRICAIN / KLAUENHAMMER / MARTELLO CARPENTIERE /  
 MARTELO DE UNHA MOD. AMERICANO / МОЛОТОК-ГВОЗДОДЕР АМЕРИКАНСКИЙ  
 ТИП



COD.	
AD697437	250
AD697447	350
AD697457	450
AD697467	525
AD697477	600

CARACTERÍSTICAS / FEATURES / CARACTÉRISTIQUES

Fibra de vidrio / Fiberglass / Fibre de verre

• Para más información de dimensiones y características del producto, consultar en el capítulo correspondiente del catálogo general o en [www.egamaster.com](http://www.egamaster.com). / For more details about features and dimensions of the products, check the corresponding chapter of the General Catalogue or [www.egamaster.com](http://www.egamaster.com). / Pour plus d'informations sur les dimensions et les caractéristiques du produit, consulter le chapitre correspondant de notre catalogue général ou sur [www.egamaster.com](http://www.egamaster.com).



- ANTICHISPA / NON-SPARKING / ANTIDÉFLAGRANT / FUNKENFREI / ANTISCINTILLA / ANTIDÉFLAGRANT / ИСКРОБЕЗОПАСНЫЙ
- MACETA OCTOGONAL / SLEDGE HAMMER / MASSETTE OCTOGONALE / SCHLAGHAMMER / MAZZETTA OTTOGONALE / MARRETA OCTOGONAL / КУВАЛДА



COD.	Kg
AD705047	2

CARACTERÍSTICAS / FEATURES / CARACTÉRISTIQUES

Cu-Be
Fibra de vidrio / Fiberglass / Fibre de verre

- CONSTRUCCIÓN / CONSTRUCTION / CONSTRUCTION / BAUWESEN / COSTRUZIONI / CONSTRUÇÃO / СТРОИТЕЛЬСТВО
- PALANCA DE ENCOFRADOR / WRECKING BAR / PINCE À DECOFFRER / NAGELEISEN / LEVERINO CARPENTIERE / ALAVANCAS DE ENCOFRADOR / МОТИРОВАКА



COD.	L (inch)
AD632627	18

- MEDICIÓN Y DETECCIÓN / MEASURING AND DETECTION / MESURE ET DÉTECTION / MESSTECHNIK UND DETEKTION / MISURAZIONE E RILEVAMENTO / MEDIÇÃO E DETECÇÃO / ИЗМЕРЕНИЕ И ОПРЕДЕЛЕНИЕ

- FLEXÓMETROS / MEASURING TAPES / MÈTRES À RUBAN / STAHLROLLBANDMASSE / FLESSOMETRI / FITAS METRICAS / РУЛЕТКИ
- ROBUST II



COD.	L (m/inch)	mm
AD653587	5/16	25

- NIVELES / SPIRIT LEVELS / NIVEAUX / WASSERWAAGEN / LIVELLE / NIVEIS / ЖИДКОСТНОЙ УРОВЕНЬ

TUBULAR MAGNÉTICO DE PRECISIÓN 1MM-M / 1MM-M ACCURACY MAGNETIC SPIRIT LEVEL / NIVEAU TUBULAIRE DE PRECISION 1MM-M MAGNETIQUE / MAGNETISCHE WASSERWAGEN 1MM-M ACCURAT / LIVELLA MAGNETICA TUBOLARE DI PRECISIONE 1MM-M / NIVEL TUBULAR DE PRECISÃO 1MM-M MAGNETICO / МАГНИТНЫЕ ЖИДКОСТНЫЕ УРОВНИ С ТОЧНОСТЬЮ 1MM-M



COD.	L (mm)	Precisión / Accuracy / Précision
AD651457	400	1 mm/m

MAGNET

CARACTERÍSTICAS / FEATURES / CARACTÉRISTIQUES

Aluminio / Aluminum / Aluminium
---------------------------------

TUBULAR DE PRECISIÓN 1MM-M ESCALA GRADUADA / GRADUATED SCALE 1MM-M ACCURACY SPIRIT LEVEL / NIVEAU TUBULAIRE DE PRECISION 1MM-M ECHELLE GRADUEE / GRADUAL WASSERWAGEN 1MM-M ACCURAT / LIVELLA TUBOLARE DI PRECISIONE CON SCALA GRADUATA 1MM-M / NIVEL TUBULAR DE PRECISÃO 1MM-M ESCALA GRADUADA / ГРАДУИРОВАННАЯ ШКАЛА С ЖИДКОСТНЫМ УРОВНЕМ 1MM-M



COD.	L (mm)
AD651487	300

CARACTERÍSTICAS / FEATURES / CARACTÉRISTIQUES

Aluminio / Aluminum / Aluminium
---------------------------------





■ **TORPEDO / TORPEDO / TORPILLE / TORPEDO WASSERWAGEN / LIVELLA TORPEDO / NIVEL TORPEDO / ТОРПЕДО**



COD.	L (mm)
AD651587	220



**CARACTERÍSTICAS / FEATURES / CARACTÉRISTIQUES**

Plástico + Aluminio / Plastic + Aluminum / Plastique + Aluminium

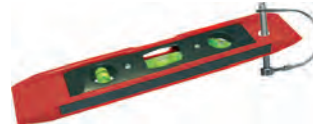

COD.	L (mm)
AD651597	220



**CARACTERÍSTICAS / FEATURES / CARACTÉRISTIQUES**

Plástico / Plastic / Plastique

■ **BUSCAPOLOS / VOLTAGE TESTER / TESTEUR / SPANNUNGSPRÜFER / CERCAFASE / BUSCA-POLOS / ИЗМЕРИТЕЛЬ НАПРЯЖЕНИЯ**



COD.	V	L (mm)
AD660727	100-250	150
AD660737		190

■ **GALGAS PARA ROSCAS / THREAD PITCH GAUGES / JAUGE POUR FILETAGE / GEWINDESCHABLONEN / GALGAS PARA ROSCAS / CONTA FIOS DE ROSCA / ИЗМЕРИТЕЛИ РЕЗЬБЫ**



COD.	N.º Hojas / No. Blades / Nro. Lames
AD655717	24



COD.	N.º Hojas / No. Blades / Nro. Lames
AD655767	12

■ **GALGAS DE ESPESORES DE PRECISIÓN / PRECISION FEELER GAUGE / JAUGES D'ÉPAISSEUR DE PRÉCISION / PRÄZISION FÜHLERLEHRE FÄCHER / SPESSIMETRI DI PRECISIONE / APALPA FOLGAS DE PRECISÃO / СВЕРХТОЧНЫЕ ЩУПЫ В КОРПУСЕ**



COD.	N.º Hojas / No. Blades / Nro. Lames
AD655707	32

ACO

ANTIDROP AISLADA 1000V / INSULATED ANTIDROP 1000V / ANTIDROP ISOLÉS 1000V / ANTIDROP 1000V ISOLIERT / ANTI-CADUTA ISOLATA 1000V / ANTIDROP ISOLADA 1000V / ПРОТИВОУДАРНЫЙ ИЗОЛИРУЮЩИЙ 1000V

ALICATES / PLIERS / PINCES / ZANGEN / PINZE / ALICATES / ПЛОСКОГУБЦЫ

TITACROM® BIMAT 1000V

UNIVERSALES / COMBINATION / UNIVERSELLES / KOMBIZANGEN / UNIVERSALE / UNIVERSAIS / КОМБИНИРОВАННЫЕ



COD.	L (mm)
AD765827	165
AD765837	180
AD765847	200

TITACROM® BIMAT 1000V | IEC 60900 | DIN 5746

CARACTERÍSTICAS / FEATURES / CARACTÉRISTIQUES

Cr-V

BOCA PLANA / FLAT NOSE / BECS PLATS / FLACHZANGEN / BECCHI PIATTI / PONTAS CHATAS / УТКОНОСЫ



COD.	L (mm)
AD765897	160

TITACROM® BIMAT 1000V | IEC 60900 | DIN 5745

CARACTERÍSTICAS / FEATURES / CARACTÉRISTIQUES

Cr-V

BOCA REDONDA / ROUND NOSE / BECS RONDOS / RUNDZANGEN / BECCHI TONDI / PONTAS REDONDAS / КРУГЛОГУБЦЫ



COD.	L (mm)
AD765907	160

TITACROM® BIMAT 1000V | IEC 60900 | DIN 5745

CARACTERÍSTICAS / FEATURES / CARACTÉRISTIQUES

Cr-V

TELEFONISTA / LONG NOSE / TÉLÉPHONE / TELEFONZANGEN / TELEFONISTI / TELEFONISTA / С УДЛИННЕННЫМИ НОСАМИ



COD.	L (mm)
AD765917	160
AD765927	200

TITACROM® BIMAT 1000V | IEC 60900 | DIN 5745

CARACTERÍSTICAS / FEATURES / CARACTÉRISTIQUES

Cr-V

TELEFONISTA BOCA CURVA / BENT NOSE PLIERS / TÉLÉPHONE BECS COUDÉS / TELEFONZANGEN GEBOGEN / TELEFONISTI BECCHI PIEGATI / TELEFONISTA PONTAS CURVAS / С ИЗОГНУТЫМИ НОСАМИ



COD.	L (mm)
AD765937	160
AD765947	200

TITACROM® BIMAT 1000V | IEC 60900 | DIN 5745

CARACTERÍSTICAS / FEATURES / CARACTÉRISTIQUES

Cr-V

CORTE DIAGONAL / DIAGONAL CUTTING PLIERS / COUPANTES DIAGONALES / SEITENSCHNEIDER / TAGLIO LATERALE / CORTE DIAGONAL / УДЛИННЕННЫЕ ТОНКИЕ



COD.	L (mm)
AD765957	160
AD765967	190

TITACROM® BIMAT 1000V | IEC 60900 | DIN 5749

CARACTERÍSTICAS / FEATURES / CARACTÉRISTIQUES

Cr-V

CORTE DIAGONAL REFORZADO / HEAVY DUTY CUTTING NIPPERS / COUPANTES RENFORCÉS / VERSTÄRKTER SEITENSCHNEIDER / TAGLIO LATERALE RINFORZATO / CORTE DIAGONAL REFORÇADO / УСИЛЕННЫЕ БОКОРЕЗЫ



COD.	L (mm)
AD765977	180
AD765987	200

TITACROM® BIMAT 1000V | IEC 60900 | DIN 5749

CARACTERÍSTICAS / FEATURES / CARACTÉRISTIQUES

Cr-V

CORTE FRONTAL / END CUTTING NIPPER / COUPANTES DEVANT / VORSCHNEIDER / TAGLIO FRONTALE / CORTE FRONTAL / КЛЕЩИ



COD.	L (mm)
AD765997	160

TITACROM® BIMAT 1000V | IEC 60900 | DIN 5748

CARACTERÍSTICAS / FEATURES / CARACTÉRISTIQUES

Cr-V

ACO

**CORTE FRONTAL ELECTRICISTA / END CUTTING NIPPER (ELECTRICIAN) / COUPANTES DEVANT ELECTRICIEN / ELEKTRIKER VORSCHNEIDER / TAGLIO FRONTALE PER ELETTRICISTI / CORTE FRONTAL ELETTRICISTA / КЛЕЩИ (ЭЛЕКТРИЧЕСКИЕ)**



COD.	L (mm)
AD766007	160
AD766027	200

TITACROM® BIMAT 1000V IEC 60900 I DIN 5748

CARACTERÍSTICAS / FEATURES / CARACTÉRISTIQUES

Cr-V

**PELACABLES / WIRESTRIPPER / PINCES À DÉNUDER / ABISOLIERZANGEN / PINZE SPRELFILI / DECAPADORES / КЛЕЩИ ДЛЯ ЗАЧИСТКИ КОНТАКТОВ**



COD.	L (mm)
AD766037	160

TITACROM® BIMAT 1000V IEC 60900 I DIN 5743

CARACTERÍSTICAS / FEATURES / CARACTÉRISTIQUES

Cr-V

**MASTERCUT TITACROM® BIMAT 1000V**

**UNIVERSALES / COMBINATION / UNIVERSELLES / KOMBIZANGEN / UNIVERSALI / UNIVERSAIS / КОМБИНИРОВАННЫЕ**



COD.	L (mm)
AD766067	165
AD766077	180
AD766097	210

TITACROM® BIMAT 1000V IEC 60900 I DIN 5746

CARACTERÍSTICAS / FEATURES / CARACTÉRISTIQUES

Cr-V



COD.	L (mm)
AD766117	235

TITACROM® BIMAT 1000V IEC 60900 I DIN 5746

CARACTERÍSTICAS / FEATURES / CARACTÉRISTIQUES

Cr-V

**TELEFONISTA / LONG NOSE / TÉLÉPHONE / TELEFONZANGEN / TELEFONISTI / TELEFONISTA / С УДЛИННЕННЫМИ НОСАМИ**



COD.	L (mm)
AD766127	160
AD766137	200

TITACROM® BIMAT 1000V IEC 60900 I DIN 5745

CARACTERÍSTICAS / FEATURES / CARACTÉRISTIQUES

Cr-V

**TELEFONISTA BOCA CURVA / BENT NOSE PLIERS / TÉLÉPHONE BECS COUDÉS / TELEFONZANGEN GEBOGEN / TELEFONISTI BECCHI PIEGATI / TELEFONISTA PONTAS CURVAS / С ИЗОГНУТЫМИ НОСАМИ**



COD.	L (mm)
AD766147	160
AD766157	200

TITACROM® BIMAT 1000V IEC 60900 I DIN 5745

CARACTERÍSTICAS / FEATURES / CARACTÉRISTIQUES

Cr-V

**CORTE DIAGONAL / DIAGONAL CUTTING PLIERS / COUPANTES DIAGONALES / SEITENSCHNEIDER / TAGLIO LATERALE / CORTE DIAGONAL / УДЛИННЕННЫЕ ТОНКИЕ**



COD.	L (mm)
AD766167	160
AD766177	190

TITACROM® BIMAT 1000V IEC 60900 I DIN 5749

CARACTERÍSTICAS / FEATURES / CARACTÉRISTIQUES

Cr-V

**CORTE DIAGONAL REFORZADO / HEAVY DUTY CUTTING NIPPERS / COUPANTES RENFORCÉS / VERSTÄRKTER SEITENSCHNEIDER / TAGLIO LATERALE RINFORZATO / CORTE DIAGONAL REFORÇADO / УСИЛЕННЫЕ БОКОРЕЗЫ**



COD.	L (mm)
AD766187	180
AD766197	200

TITACROM® BIMAT 1000V IEC 60900 I DIN 5749

CARACTERÍSTICAS / FEATURES / CARACTÉRISTIQUES

Cr-V

• Para más información de dimensiones y características del producto, consultar en el capítulo correspondiente del catálogo general o en [www.egamaster.com](http://www.egamaster.com). / For more details about features and dimensions of the products, check the corresponding chapter of the General Catalogue or [www.egamaster.com](http://www.egamaster.com). / Pour plus d'informations sur les dimensions et les caractéristiques du produit, consulter le chapitre correspondant de notre catalogue général ou sur [www.egamaster.com](http://www.egamaster.com).



ALICATE DE PRESIÓN / PRESSURE PLIER / PINCE DE PRÉHENSION / KLEMMZANGE / PINZA A PRESSIONE / ALICATE TIPO UNIVERSAL ISOLADO / СЖИМАЮЩИЕ КЛЕЩИ



COD.	L (mm)
AD732487	150

⚡ 1000V | IEC 60900

CARACTERÍSTICAS / FEATURES / CARACTÉRISTIQUES

Para el montaje y bloqueo de contadores / For meter assembly and meter blocking / Conçue pour le montage et le verrouillage des compteurs

GRAPA / INSULATING CLAMP / AGRAFE / KLEMMZANGE ISOLIERT / MORSETTO ISOLATO / GRAMPO ISOLADO / ИЗОЛИРОВАННЫЕ КЛЕЩИ



COD.	L (mm)
AD732497	150

⚡ 1000V | IEC 60900

CARACTERÍSTICAS / FEATURES / CARACTÉRISTIQUES

Para sujeción de las mantas aislantes / For holding insulating mats in place / Pour fixer des nappes isolantes

ELECTRICIDAD / ELECTRICIAN TOOLS / OUTILLAGE D'ÉLECTRICIEN / WERKZEUGE FÜR ELEKTRIKER / UTENSILI PER ELETTRICISTI / ELECTRICIDADE / ИНСТРУМЕНТ ДЛЯ ЭЛЕКТРИКОВ

ALICATE PARA UNIÓN DE CABLES AISLADOS Y NO AISLADOS / PLIER FOR CABLE LINKS INSULATED & NON INSULATED / PINCE POUR UNION DE CABLES ISOLES ET NON ISOLES / ZANGE FÜR ISOLIERTE UND NICHT ISOLIERTE KABELSCHUHE / PINZE PER UNIRE CAVI ISOLATI E NON ISOLATI / ALICATE PARA UNIÃO DE CABOS ISOLADOS E NÃO ISOLADOS / КЛЕЩИ ДЛЯ ИЗОЛИРОВАННЫХ И НЕИЗОЛИРОВАННЫХ КОНТАКТОВ



COD.	L (mm)
AD732577	230

⚡ 1000V | IEC 60900

CORTACABLES DE CARRACA / RATCHET ELECTRICIAN CABLE CUTTER / COUPE-CABLES À CLIQUET / KABELSCHNEIDER MIT RATSCHÉ / TAGLIACAVI CRICCO PER ELETTRICI / CORTA CABOS DE ROQUETE PARA ELETTRICISTA / КАБЕЛЕРЕЗЫ С СТРЕЧЕТОЧНЫМ МЕХАНИЗМОМ



COD.	L (mm)	O.D. mm
AD730107	260	32
AD730117	380	52

⚡ 1000V | IEC 60900

TIJERAS / TIN SNIPS / CISAILLES / BLECHSCHERE / FORBICI / TESOURAS / НОЖНИЦЫ ДЛЯ ЖЕСТИ



COD.	L (mm)
AD790577	160

⚡ 1000V | IEC 60900



COD.	L (mm)
AD790587	160

⚡ 1000V | IEC 60900

CARACTERÍSTICAS / FEATURES / CARACTÉRISTIQUES

Muesca pequeña / Small breach / Petite brèche



COD.	L (mm)
AD790597	160

⚡ 1000V | IEC 60900

CARACTERÍSTICAS / FEATURES / CARACTÉRISTIQUES

Muesca grande / Big breach / Grande brèche



**PELACABLES / CABLE STRIPPER / PINCES À DÉNUDER / ABISOLIERZANGE / SPELACAVI / DECAPADOR DE CABOS / СТРИППЕР**



COD.	O.D. (mm)
AD730887	25-45
⚡ 1000V   IEC 60900	

**CUCHILLOS / KNIVES / COUTEAUX / MESSER / LAME / FACIA / НОЖИ**



COD.	L (mm)
AD730357	170
⚡ 1000V   IEC 60900	

**CARACTERÍSTICAS / FEATURES / CARACTÉRISTIQUES**

Recto / Straight / Droit



COD.	L (mm)
AD730367	180
⚡ 1000V   IEC 60900	

**CARACTERÍSTICAS / FEATURES / CARACTÉRISTIQUES**

Curvo / Curved / Coudé

**TENAZAS / PINCERS / PINCES / ZANGE / TENAGLIE / ALICATES / КЛЕЩИ**

**DE CANAL / BOX JOINT / MULTIPRISE ENTREPASSÉE / WASSERPUMPENZANGE / PINZE REGOLABILI / BICO DE PAPAGAIO / КЛЕЩИ ШАРНИРНЫЕ**



COD.	L (inch)
AD730047	10
AD730057	12
⚡ 1000V   IEC 60900	

**PICO DE LORO / GROOVE JOINT / MULTIPRISE À CRÉMAILLÈRE / WASSERPUMPENZANGE / PINZE REGOLABILI / BICO DE PAPAGAIO / КЛЕЩИ ЖЕЛОБКОВОГО ТИПА**



COD.	L (inch)
AD730017	10
⚡ 1000V   IEC 60900	

**TENAZAS CORTACABLES / CABLE CUTTERS / COUPE-CABLES / KABELSCHNEIDER / CESCOIE PER CAVI / TESOURAS CORTA CABOS / КАБЕЛЕРЕЗЫ**



COD.	L (mm)
AD761477	150
⚡ 1000V   IEC 60900	



COD.	L (mm)
AD730087	250
⚡ 1000V   IEC 60900	



COD.	L (mm)
AD730097	600
⚡ 1000V   IEC 60900	

**CORTAVARILLAS / BOLT CUTTERS / COUPE-BOULONS / BOLZENSCHNEIDER / TAGLIABULLONI / CORTA VARÃO / АРМАТУРНЫЕ НОЖНИЦЫ**



COD.	L (inch)
AD730207	18
AD730217	24
⚡ 1000V   IEC 60900	



**CORTATUBOS PARA TUBO DE PLÁSTICO / PLASTIC PIPE CUTTER / COUPE-TUBE  
 PLASTIQUE / KUNSTSTOFFROHRSCHERE / CESCOIA PER TUBI DI PLASTICA / TESOURA  
 PARA TUBO DE PLASTICO / ТРУБОРЕЗ ДЛЯ ПЛАСТИКА**

PIRAINA®



COD.



AD761457

64

1000V I IEC 60900

**CORTABRIDAS / PLASTIC TIE CUTTER / PINCE COUPE COLLIERS PLASTIQUES /  
 KABELBINDER SCHNEIDER / PINZA TAGLIA FASCETTE IN NYLON / CORTA-  
 ABRAÇADEIRA / РЕЗАК ДЛЯ ПЛАСТИКОВЫХ ХОМУТОВ**



COD.

L (mm)

AD730427

150

1000V I IEC 60900 I RCD Nº 2029504

**LLAVE HEAVY DUTY CURVA / OFFSET HEAVY DUTY PIPE WRENCH / CLÉ SERRE-TUBES  
 HEAVY DUTY COUDEE / GEKRÖPFTE ROHRZANGE / GIRATUBI MODELLO AMERICANO  
 CURVO / CHAVE HEAVY DUTY INCLINADA / ИЗОГНУТЫЕ ТРУБНЫЕ КЛЮЧИ ДЛЯ  
 БОЛЬШИХ НАГРУЗОК**



COD.

L (inch)

AD767587

8

AD767597

10

AD767607

12

AD767617

14

AD767627

18

1000V I IEC 60900

**LLAVES AJUSTABLES / ADJUSTABLE WRENCHES / CLÉS À MOLETTE /  
 ROLLGABELSCHLÜSSEL / CHIAVI REGOLABILI A RULLINO / CHAVES AJUSTAVELS /  
 РАЗВОДНЫЕ КЛЮЧИ**

TITACROM®



COD.

L (inch)

L (mm)

AD765507

6

150

AD765517

8

200

AD765527

10

250

AD765537

12

300

TITACROM® 1000V



**FOSFATADA / PHOSPHATED / PHOSPHATÉE BRUNIE / PHOSPHATIERT / FINITURA  
 BRUNITA / BRUNIDA / ЧЕРНЕННЫЙ**



COD.

L (inch)

L (mm)

AD765547

6

150

AD765557

8

200

AD765567

10

250

AD765577

12

300

1000V

COMBI / COMBI / COMBI / KOMBI / COMBI / COMBI / КОМБИ



TITACROM®



COD.

L (inch)

L (mm)

AD765637

12

300

TITACROM® 1000V

**MOLETA LATERAL / LATERAL NUT / MOLETTE LATÉRALE / MIT SCHNECKENROLLE /  
 RULLINO LATERALE / MOLETA LATERAL / РИГУЛИРОВОЧНАЯ ШАЙБА**



TITACROM®



COD.

L (inch)

L (mm)

AD765787

6

150

AD765797

8

200

AD765807

10

250

AD765817

12

300

TITACROM® 1000V



■ LLAVES / WRENCHES / CLÉS / SCHLÜSSEL / CHIAVI / CHAVES / КЛЮЧИ

FIJA DE UNA BOCA / SINGLE ENDED OPEN JAW SPANNER / À FOURCHE / EINMAULSCHLÜSSEL / FISSE SEMPLICE / FIXA DE UMA BOCA / ОДНОРОЖКОВЫЙ КЛЮЧ

■ MM



COD.	AP mm
AD730867	5,5
AD730607	6
AD730617	7
AD730627	8
AD730637	9
AD730647	10
AD730657	11
AD730667	12
AD730677	13
AD730687	14
AD730697	15
AD730707	16
AD730717	17
AD730727	18
AD730737	19
AD730747	20
AD730757	21
AD730767	22
AD730787	23
AD730777	24
AD730797	27
AD730807	28
AD730817	29
AD730827	30
AD730837	32

⚡ 1000V | IEC 60900

■ INCH



COD.	AP inch
AD730437	1/4
AD730447	9/32
AD730457	5/16
AD730467	3/8
AD730477	7/16
AD730487	1/2
AD730497	9/16
AD730507	5/8
AD730517	11/16
AD730527	3/4
AD730537	13/16
AD730547	7/8
AD730557	15/16

⚡ 1000V | IEC 60900

LLAVE DE ESTRELLA ACODADA UNA BOCA / OFFSET RING WRENCH / CLÉ POLYGONALE CONTRE-COUDÉE / GEKRÖPFTE RINGSCHLÜSSEL / CHIAVE POLIGONALE AD UNA BOCCA / CHAVE DE LUNETAS INCLINADA / КЛЮЧ ИЗОГНУТАЯ ЗВЕЗДОЧКА

■ MM



COD.	AP mm
AD730907	6
AD730917	7
AD730927	8
AD730937	9
AD730947	10
AD730957	11
AD730967	12
AD730977	13
AD730987	14
AD730997	15
AD731007	16
AD731017	17
AD731027	18
AD731037	19
AD731057	21
AD731067	22
AD731077	23
AD731087	24
AD731097	26
AD731107	27
AD731117	28
AD731127	29
AD731137	30
AD731147	32
AD731157	36
AD731167	38
AD731177	41
AD731187	42
AD731197	46
AD731047	50

⚡ 1000V | IEC 60900

■ INCH



COD.	AP inch
AD733477	1/4
AD733487	5/16
AD733497	3/8
AD733507	7/16
AD733517	1/2
AD733527	9/16
AD733537	5/8
AD733547	11/16
AD733557	3/4

• Para más información de dimensiones y características del producto, consultar en el capítulo correspondiente del catálogo general o en [www.egamaster.com](http://www.egamaster.com). / For more details about features and dimensions of the products, check the corresponding chapter of the General Catalogue or [www.egamaster.com](http://www.egamaster.com). / Pour plus d'informations sur les dimensions et les caractéristiques du produit, consulter le chapitre correspondant de notre catalogue général ou sur [www.egamaster.com](http://www.egamaster.com).



COD.	AF inch
AD733567	13/16
AD733577	7/8
AD733587	15/16
AD733597	1
AD733607	1.1/16
AD733617	1.1/8
AD733637	1.1/4

1000V | IEC 60900

**LLAVE DE ESTRELLA DE CARRACA PLANA / RING RATCHET / POLYGONALE À CLIQUET / KNARRE RINGSCHÜSSEL / CHIAVE POLIGONALE PIATTA CON CRICCO / CHAVE DE LUNETA  
 COM ROQUETE PLANA / ЗВЕЗДОЧКА С ТРЕЩЕТКОЙ**

MM



COD.	AF mm
AD731457	10
AD731477	13
AD731507	17
AD731527	19

1000V | IEC 60900

**LLAVE DE ESTRELLA INCLINADA UNA BOCA / ANGLE RING WRENCH / CLÉ POLYGONALE DROITE / GEBOGEN RINGSCHLÜSSEL / CHIAVE A STELLA INCLINATA / CHAVE LUA / КЛЮЧ  
 ЗВЕЗДОЧКА ИЗОГНУТАЯ**

MM



COD.	AF mm
AD731207	8
AD731217	9
AD731227	10
AD731237	11
AD731247	12
AD731257	13
AD731267	14
AD731277	15
AD731287	16
AD731297	17
AD731307	18
AD731317	19
AD731337	21
AD731347	22
AD731357	23
AD731367	24

1000V | IEC 60900

INCH



COD.	AF inch
AD731607	5/16
AD731897	3/8
AD731907	7/16
AD731917	1/2
AD731927	9/16
AD731987	5/8
AD731997	11/16
AD732007	3/4
AD732017	7/8
AD732027	15/16

1000V | IEC 60900





LLAVES DE PIPA ABIERTAS / ANGLED OPEN SOCKETS / CLÉS À PIPE /  
 PFEIFFENKOPFSCHLÜSSEL / CHIAVI A PIPA APERTE / CHAVE DE CACHIMBO ABERTAS /  
 ГОЛОВКА С РУКОЯТКОЙ ПОД 90 ГРАДУСОВ

MM



COD.	AF mm
AD732037	8
AD732047	9
AD732057	10
AD732067	11
AD732077	12
AD732087	13
AD732097	14
AD732107	15
AD732117	16
AD732127	17
AD732137	18
AD732147	19
AD732157	20
AD732167	21
AD732177	22
AD732187	23
AD732197	24
AD732207	25
AD732217	26
AD732227	27
AD732237	28
AD732247	29
AD732257	30
AD732267	32

1000 V | IEC 60900

LLAVE DE TUBO MANGO EN T / T HANDLE WRENCH / CLÉ EN T / T-GRIFF SCHLÜSSEL /  
 CHIAVE A TUBO CON IMPUGNATURA A T / CHAVES T TUBOLARES / ГОЛОВКА С  
 РУКОЯТКОЙ Т

MM



COD.	AF mm
AD731707	6
AD731717	7
AD731727	8
AD731737	9
AD731747	10
AD731757	11
AD731767	12
AD731777	13
AD731787	14
AD731797	15
AD731807	16
AD731817	17
AD731827	18
AD731837	19
AD731847	20
AD731857	21
AD731867	22
AD731877	23
AD731887	24

1000 V | IEC 60900

LLAVES HEXAGONALES / HEXAGONAL KEYS / CLÉS MÂLES / WINKELSCHRAUBENDREHER / CHIAVI ESAGONALI / CHAVES HEXAGONAIS / ШЕСТИГРАННЫЕ КЛЮЧИ

MM



COD.	AF mm
AD793707	3
AD793717	4
AD793727	5
AD793737	6
AD793747	8
AD793757	10
AD793767	12

1000 V | IEC 60900

INCH



COD.	AF Inch
AD793777	1/8
AD793787	9/64
AD793797	5/32
AD793807	3/16
AD793817	7/32
AD793827	1/4
AD793837	5/16
AD793847	3/8
AD793857	7/16
AD793867	1/2
AD793877	5/8

1000 V | IEC 60900

• Para más información de dimensiones y características del producto, consultar en el capítulo correspondiente del catálogo general o en [www.egamaster.com](http://www.egamaster.com). / For more details about features and dimensions of the products, check the corresponding chapter of the General Catalogue or [www.egamaster.com](http://www.egamaster.com). / Pour plus d'informations sur les dimensions et les caractéristiques du produit, consulter le chapitre correspondant de notre catalogue général ou sur [www.egamaster.com](http://www.egamaster.com).



LLAVES HEXAGONALES EN T / T HEXAGONAL KEYS / CLÉS MÂLES EN T / T-INBUSSCHLÜSSEL / CHIAVI ESAGONALI A T / CHAVES HEXAGONAIS EM T / Т-ОБРАЗНЫЕ КЛЮЧИ ДЛЯ ШЕСТИГРАННИКОВ

MM



COD.	AF mm
AD793907	5
AD793917	6
AD793927	8
AD793937	10

⚡ 1000V | IEC 60900

DESTORNILLADORES / SCREWDRIVERS / TOURNEVIS / SCHRAUBENZIEHER / CACCIAVITI / CHAVES DE FENDA / ОТВЕРТКИ

MASTERTORK

ELECTRICISTA / ELECTRICIAN / ELECTRICIEN / ELEKTRIK / PER ELETTRICISTI / ELETRICISTA / ЭЛЕКТРИЧЕСКАЯ

MM



COD.	mm	mm
AD766207	2,5	75
AD766217	3	100
AD766227	4	125
AD766237	5,5	150
AD766247	6,5	175
AD766257	8	200
AD766267	10	

⚡ 1000V | IEC 60900 | DIN 5265

INCH



COD.	inch	inch
AD750637	3/32	3
AD750647	1/8	4
AD750657	5/32	5
AD750667	7/32	6
AD750677	1/4	7
AD750687	5/16	8
AD750697	25/64	

⚡ 1000V | IEC 60900 | DIN 5265

PHILIPS



COD.		mm
AD766287	PH-0	60
AD767387	PH-1	80
AD766297	PH-2	100
AD766307	PH-3	125
AD766317	PH-4	150
AD766327		200

⚡ 1000V | IEC 60900 | DIN 5262

PLANO-PHILIPS PARA BORNES ELÉCTRICOS / SLOTTED-PHILIPS FOR TERMINAL SCREWS / PHILIPS-À FENTE POUR BORNES ÉLECTRIQUES / SCHLITZ-PHILIPS SCHRAUBENDREHER FÜR SCHRAUBKLEMMEN / TAGLIO-PHILIPS PER TERMINALI ELETTRICI / FENDA-PHILIPS PARA BORNES ELÉCTRICOS / ОТВЕРТКА КРЕСТОВАЯ КЛЕМНАЯ PH



COD.		mm
AD791637	PH-1	100
AD791647	PH-2	125

⚡ 1000V | IEC 60900



### POZIDRIV®\*



COD.		
AD766337	PZ-0	60
AD766347	PZ-1	100
AD766357	PZ-2	125
AD766367	PZ-3	150
AD766377	PZ-4	200

1000V | IEC 60900 | DIN 5262

### TORX®\*



COD.		
AD766387	T-6	50
AD766397	T-7	
AD766407	T-8	
AD766417	T-9	
AD766427	T-10	
AD766437	T-15	75
AD766447	T-20	
AD766457	T-25	100
AD766467	T-27	
AD766477	T-30	
AD766487	T-40	125
AD766497	T-45	
AD766507	T-50	175

1000V | IEC 60900 | DIN 5262

### HEXAGONAL ALLEN

#### MM



COD.		
AD747107	2,5	75
AD747117	3	
AD747127	4	100
AD747137	5	
AD747147	6	125
AD747157	8	150

1000V | IEC 60900

**PLANO-POZIDRIV®\* PARA BORNES ELÉCTRICOS / SLOTTED-POZIDRIV®\* FOR TERMINAL SCREWS / POZIDRIV®\* -À FENTE POUR BORNES ÉLECTRIQUES / SCHLITZ-POZIDRIV®\* SCHRAUBENDREHER FÜR SCHRAUBKLEMMEN / TAGLIO-POZIDRIV®\* PER TERMINALI ELETTRICI / FENDA-POZIDRIV®\* PARA BORNES ELÉCTRICOS / ОТВЕРТКА КРЕСТОВАЯ КЛЕММНАЯ POZIDRIV®\***



COD.		
AD791657	PZ-1	100
AD791667	PZ-2	125

1000V | IEC 60900

### TAMPER TORX



COD.		
AD750377	TT-6	50
AD750387	TT-7	
AD750397	TT-8	
AD750407	TT-9	
AD750417	TT-10	
AD750427	TT-15	75
AD750437	TT-20	
AD750447	TT-25	100
AD750457	TT-27	
AD750467	TT-30	
AD750477	TT-40	125
AD750487	TT-45	
AD750497	TT-50	175

1000V | IEC 60900

### INCH



COD.		
AD750837	1/8	3
AD750847	5/32	4
AD750977	5/16	6

1000V | IEC 60900

- Para más información de dimensiones y características del producto, consultar en el capítulo correspondiente del catálogo general o en [www.egamaster.com](http://www.egamaster.com). / For more details about features and dimensions of the products, check the corresponding chapter of the General Catalogue or [www.egamaster.com](http://www.egamaster.com). / Pour plus d'informations sur les dimensions et les caractéristiques du produit, consulter le chapitre correspondant de notre catalogue général ou sur [www.egamaster.com](http://www.egamaster.com).
- \*Para tornillos POZIDRIV® (Marca registrada por European Ind. Serv. Ltd.) / \*For screws POZIDRIV® (European Ind. Serv. Ltd. registered trademark) / \*Pour vis POZIDRIV® (Marque enregistrée par European Ind. Serv. Ltd.)
- \*Para tornillos TORX® (Marca registrada por Acument Intellectual Properties, LLC, Troy, Mich., US) / \*For screws TORX® (Acument Intellectual Properties, LLC, Troy, Mich., US registered trademark) / \*Pour vis TORX® (Marque enregistrée par Acument Intellectual Properties, LLC, Troy, Mich., US)



■ DE VASO / SOCKET SCREWDRIVER / CLÉ À DOUILLE EMMANCHÉE / 6-KANT STECKSCHLÜSSEL / BUSSOLE / DE CAIXA / ОТВЕРТКА С ГОЛОВКОЙ

■ MM



COD.	mm	mm
AD746987	4	
AD746997	5	150
AD747007	5,5	
AD747017	6	160
AD747027	7	
AD747037	8	
AD747047	9	
AD747057	10	
AD747067	11	175
AD747077	12	
AD747087	13	
AD747097	14	

⚡ 1000V | IEC 60900

■ MM



COD.	mm	mm
AD746647	9	
AD746657	10	
AD746667	11	
AD746677	12	130
AD746687	13	
AD746697	14	
AD746707	17	

⚡ 1000V | IEC 60900

■ ROTORK

■ ELECTRICISTA / ELECTRICIAN / ELECTRICIEN / ELEKTRIK / PER ELETTRICISTI / ELETTRICISTA / ЭЛЕКТРИЧЕСКАЯ

■ MM



COD.	mm	mm
AD767307	2,5	60
AD767317	3	
AD766517		100
AD766527	4	125
AD766537	5	
AD766547	6	150
AD767327	8	175
AD767337	10	200

⚡ 1000V | IEC 60900 | DIN 5265

■ INCH



COD.	inch	inch
AD751327	5/32	
AD749847	3/16	
AD751337	7/32	6
AD749857	1/4	
AD749867	5/16	
AD749877	3/8	
AD751367	25/64	
AD749887	7/16	7
AD751387	15/32	
AD749897	1/2	

⚡ 1000V | IEC 60900

■ INCH



COD.	inch	inch
AD746717	3/16	
AD746727	1/4	
AD746737	5/16	
AD746747	3/8	5
AD746757	7/16	
AD746767	1/2	
AD746777	9/16	
AD746787	5/8	

⚡ 1000V | IEC 60900

■ INCH



COD.	inch	inch
AD751727	3/32	2
AD751737	1/8	4
AD751747		5
AD751757	5/32	
AD751767	3/16	6
AD751777	1/4	7
AD751787	5/16	8
AD751797	25/64	

⚡ 1000V | IEC 60900 | DIN 5265



### PHILIPS



COD.		
		mm
AD766557	PH-0	60
AD766567	PH-1	100
AD766577	PH-2	125
AD766587	PH-3	150
AD767357	PH-4	200

⚠ 1000V | IEC 60900 | DIN 5262

### POZIDRIV®\*



COD.		
		mm
AD766597	PZ-0	60
AD766607	PZ-1	100
AD766617	PZ-2	125
AD766627	PZ-3	150
AD767367	PZ-4	200

⚠ 1000V | IEC 60900 | DIN 5262

### MICROTRONIC

**ELECTRICISTA / ELECTRICIAN / ELECTRICIEN / ELEKTRIK / PER ELETTRICISTI /  
 ELETRICISTA / ЭЛЕКТРИЧЕСКАЯ**



COD.		
	mm	mm
AD751567	1,5	40
AD751577	1,8	60
AD751587	2	
AD751597	2,5	75
AD752017	3	

⚠ 1000V | IEC 60900 | DIN 7437

### PHILIPS



COD.		
		mm
AD752027	PH-00	
AD752037	PH-0	75

⚠ 1000V | IEC 60900 | DIN 7438

### CORTE / CUTTING / OUTILS COUPANTS / SCHNEIDWERKZEUG / ARCHETTI / CORTE / РЕЗКА

### ARCO DE SIERRA / HACK SAW / MONTURE DE SCIE À METAUX / METALLSÄGEBOGEN / ARCHETTI / ARCOS DE SERRA / HOЖOBKA



COD.		
	inch	mm
AD730297	6	150

⚠ 1000V | IEC 60900



COD.		
	inch	mm
AD730307	12	300

⚠ 1000V | IEC 60900

### ILUMINACIÓN / LIGHTING / ÉCLAIRAGE / BELEUCHTUNG / ILLUMINAZIONE / ILUMINAÇÃO / ОСВЕЩЕНИЕ

**LINTERNA DE BOLSILLO / LED POCKET FLASHLIGHT / LAMPE DE POCHE / LED-TASCHENLAMPE / TORCIA DI TASCA / LANTERNA DE BOLSO / КАРМАННЫЙ СВЕТОДИОДНЫЙ ФОНАРИК**

COD.	LED	LUMENS	L (mm)	
AD586417	CREE XPG	100	150	57



• Para más información de dimensiones y características del producto, consultar en el capítulo correspondiente del catálogo general o en [www.egamaster.com](http://www.egamaster.com). / For more details about features and dimensions of the products, check the corresponding chapter of the General Catalogue or [www.egamaster.com](http://www.egamaster.com). / Pour plus d'informations sur les dimensions et les caractéristiques du produit, consulter le chapitre correspondant de notre catalogue général ou sur [www.egamaster.com](http://www.egamaster.com).  
 • \*Para tornillos POZIDRIV® (Marca registrada por European Ind. Serv. Ltd.) / \*For screws POZIDRIV® (European Ind. Serv. Ltd. registered trademark) / \*Pour vis POZIDRIV® (Marque enregistrée par European Ind. Serv. Ltd.)



■ **BANDEJAS / TRAYS / PLATEAUX / ABLAGEKASTEN / PANNELLO / TABULEIROS / ПОДДОНЫ**

COD.	PCS.		L x W (mm)	Kg
AD500207	18	51025, 51039, 50950, 51045, 51478, 50977, 50954, 51560, 51562, 51075, 51040	565 x 405	2,8

PCS./UN.	Composición / Composition / Composition	Descripción / Description / Description	
10	AD615007	Juego de llaves hexagonales / Hexagonal keys set	-
1	AD610167	Llave HD / HD Pipe wrench	12 inch
2	AD611107, AD611117	Llaves ajustables / Adjustable wrenches	
1	AD586417	Linterna mini / Mini flashlight	
1	AD651597	Nivel magnético torpedo / Torpedo Magnetic level	-
2	AD655717, AD655767	Galgas para roscas / Thread pitch gauges	
1	AD638767	Cortador con cuchilla auto-retráctil / Cutter with auto-retractable blade	



COD.	PCS.		L x W (mm)	Medidas en / Sizes in / Mesures en	Kg
AD500217	8	51025, 51039, 50950, 51045, 51478, 50977, 50954, 51560, 51562, 51075, 51040	565 x 405	mm	3,9

Composición / Composition / Composition	Descripción / Description / Description	
AD617437, AD617447, AD617457, AD617467, AD617477, AD617487, AD617497, AD617507	Llaves combinadas / Combination wrenches	mm



COD.	PCS.		L x W (mm)	Medidas en / Sizes in / Mesures en	Kg
AD500227	7	51025, 51039, 50950, 51045, 51478, 50977, 50954, 51560, 51562, 51075, 51040	565 x 405	inch	3,3

Composición / Composition / Composition	Descripción / Description / Description	
AD603527, AD603537, AD603547, AD603557, AD603567, AD603577, AD603587	Llaves combinadas / Combination wrenches	inch

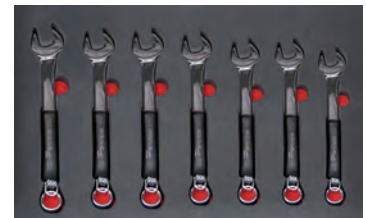

COD.	PCS.		L x W (mm)	Medidas en / Sizes in / Mesures en	Kg
AD500407	18	51025, 51039, 50950, 51045, 51478, 50977, 50954, 51560, 51562, 51075, 51040	565 x 405	mm	2,1

Composición / Composition / Composition	Descripción / Description / Description	
AD617257, AD617267, AD617277, AD617287, AD617297, AD617307, AD617317, AD617327, AD617337, AD617347, AD617357, AD617367, AD617377, AD617387, AD617397, AD617407, AD617417, AD617427	Llaves combinadas / Combination wrenches	mm

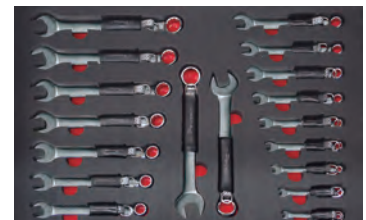

COD.	PCS.		L x W (mm)	Medidas en / Sizes in / Mesures en	Kg
AD500417	13	51025, 51039, 50950, 51045, 51478, 50977, 50954, 51560, 51562, 51075, 51040	565 x 405	inch	1,4

Composición / Composition / Composition	Descripción / Description / Description	
AD603407, AD603417, AD678787, AD603427, AD603437, AD603447, AD603457, AD603467, AD603477, AD603487, AD603497, AD603507, AD603517	Llaves combinadas / Combination wrenches	inch



COD.	PCS.		L x W (mm)	Medidas en / Sizes in / Mesures en	Kg
AD500237	13	51025, 51039, 50950, 51045, 51478, 50977, 50954, 51560, 51562, 51075, 51040	565 x 405	mm	3,9

Composición / Composition / Composition	Descripción / Description / Description	
AD617757, AD617767, AD617777, AD617787, AD617797, AD617807, AD617817, AD617827, AD617837, AD617847, AD617857, AD617867, AD617877	Llaves acodadas / Double offset ring wrenches	mm





COD.	PCS.		L x W (mm)	Medidas en / Sizes in / Mesures en	
AD500247	13		565 x 405	inch	3

Composición / Composition / Composition	Descripción / Description / Description	
AD603807, AD603817, AD603827, AD603837, AD603847, AD603857, AD603867, AD603877, AD603887, AD603897, AD603907, AD603917, AD603927	Llaves acodadas / Double offset ring wrenches	inch



COD.	PCS.		L x W (mm)	
AD500427	6		565 x 405	0,8

PCS./UN.	Composición / Composition / Composition	Descripción / Description / Description
	A66078	Cordón anticaída retráctil / Retractable lanyard
	A66062	Cordón anticaída retráctil con mosquetón / Retractable lanyard with carabiner
	A66112	Cordón anticaída con mosquetón y quitavueeltas / Carabiner lanyard with swivel
1	A66113	Cordón anticaída de nudo y quitavueeltas / Loop lanyard with swivel
	A66063	Accesorio cordón anticaída retráctil / Retractable lanyard accessory
	A66064	Accesorio cordón anticaída retráctil con mosquetón / Retractable lanyard with carabiner accessory



COD.	PCS.		L x W (mm)	
AD500257	8		565 x 405	2,8

PCS./UN.	Composición / Composition / Composition	Descripción / Description / Description
1	AD620977	Tenaza Grip / Grip plier
	AD621517	Tenaza cortacables / Cable cutters
6	AD624967, AD622997, AD623497, AD623447, AD623457, AD623377	Alicates / Pliers



COD.	PCS.		L x W (mm)	Medidas en / Sizes in / Mesures en	
AD500267	13		565 x 405	mm	1,5

PCS./UN.	Composición / Composition / Composition	Descripción / Description / Description	
1	AD624937	Alicate para terminales aislados / For insulated terminals plier	-
2	AD664027, AD664067	Destornilladores mecánicos / Slotted screwdrivers	mm
5	AD664217, AD664227, AD664237, AD664257, AD664267	Destornilladores electricistas / Electrician screwdrivers	
3	AD664387, AD664397, AD664407	Destornilladores Philips / Philips screwdriver	
1	AD664567	Destornilladores Pozidriv® / Pozidriv® screwdrivers	-
	AD653587	Flexómetro Robust Bimat / Robust Bimat Measuring tape	



COD.	PCS.		L x W (mm)	Medidas en / Sizes in / Mesures en	
AD500437	13		565 x 405	inch	1,5

PCS./UN.	Composición / Composition / Composition	Descripción / Description / Description	
1	AD624937	Alicate para terminales aislados / For insulated terminals plier	-
2	AD553327, AD553367	Destornilladores mecánicos / Slotted screwdrivers	inch
5	AD553617, AD553547, AD553557, AD553587, AD553607	Destornilladores electricistas / Electrician screwdrivers	
3	AD664387, AD664397, AD664407	Destornilladores Philips / Philips screwdriver	
1	AD664567	Destornilladores Pozidriv® / Pozidriv® screwdrivers	-
	AD653587	Flexómetro Robust Bimat / Robust Bimat Measuring tape	

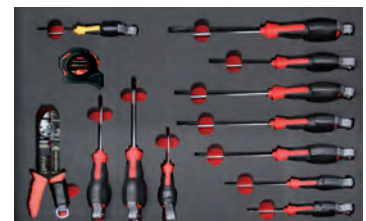

• Para más información de dimensiones y características del producto, consultar en el capítulo correspondiente del catálogo general o en [www.egamaster.com](http://www.egamaster.com). / For more details about features and dimensions of the products, check the corresponding chapter of the General Catalogue or [www.egamaster.com](http://www.egamaster.com). / Pour plus d'informations sur les dimensions et les caractéristiques du produit, consulter le chapitre correspondant de notre catalogue général ou sur [www.egamaster.com](http://www.egamaster.com).



COD.	PCS.		L x W (mm)	Kg
AD500277	5	51025, 51039, 50950, 51045, 51478, 50977, 50954, 51560, 51562, 51075, 51040	565 x 405	4,1

PCS./UN.	Composición / Composition / Composition	Descripción / Description / Description
1	AD614057	Llave para tubo Mastergrip / Mastergrip Pipe wrench
2	AD611127, AD611137	Llaves ajustables / Adjustable wrenches
	AD610447, AD610247	Llave de aluminio / Aluminium pipe wrench



COD.	PCS.		L x W (mm)	Medidas en / Sizes in / Mesures en	Kg
AD500287	6	51025, 51039, 50950, 51045, 51478, 50977, 50954, 51560, 51562, 51075, 51040	565 x 405	mm	2

PCS./UN.	Composición / Composition / Composition	Descripción / Description / Description
1	AD637427	Arco de sierra / Hack Saw
5	AD665107, AD665137, AD665177, AD665197, AD665217	Destornillador de vaso / Socket screwdriver



COD.	PCS.		L x W (mm)	Medidas en / Sizes in / Mesures en	Kg
AD500447	6	51025, 51039, 50950, 51045, 51478, 50977, 50954, 51560, 51562, 51075, 51040	565 x 405	inch	2

PCS./UN.	Composición / Composition / Composition	Descripción / Description / Description
1	AD637427	Arco de sierra / Hack Saw
5	AD553737, AD553767, AD553807, AD553827, AD553837	Destornillador de vaso / Socket screwdriver



COD.	PCS.		L x W (mm)	Kg
AD500297	5	51025, 51039, 50950, 51045, 51478, 50977, 50954, 51560, 51562, 51075, 51040	565 x 405	5,8

Composición / Composition / Composition	Descripción / Description / Description
AD697067, AD696667, AD696697, AD697077, AD697087	Martillos / Hammers



COD.	PCS.		L x W (mm)	Medidas en / Sizes in / Mesures en	Kg
AD500457	6	51025, 51039, 50950, 51045, 51478, 50977, 50954, 51560, 51562, 51075, 51040	565 x 405	mm	5,4

Composición / Composition / Composition	Descripción / Description / Description
AD650767, AD650777, AD650787, AD650797, AD650807, AD650817	Llave de carraca para estructura metálica / Podging wrench



COD.	PCS.		L x W (mm)	Kg
AD500307	14	51025, 51039, 50950, 51045, 51478, 50977, 50954, 51560, 51562, 51075, 51040	565 x 405	3,6

PCS./UN.	Composición / Composition / Composition	Descripción / Description / Description
5	AD766337, AD766347, AD766357, AD766367, AD766377	Destornilladores Pozidriv® / Pozidriv® screwdrivers
6	AD766287, AD766387, AD766297, AD766307, AD766317, AD766327	Destornilladores Philips / Philips screwdriver
	AD695347	Tijera electricista / Electrician's scissors
1	AD730357	Cuchillo / Knife
	AD660727	Buscapolos / Voltage tester







COD.	PCS.		L x W (mm)	Medidas en / Sizes in / Mesures en	
<b>AD500317</b>	10		51025, 51039, 50950, 51045, 51478, 50977, 50954, 51560, 51562, 51075, 51040	inch	1,4
PCS./UN.	Composición / Composition / Composition		Descripción / Description / Description		
7	AD750647, AD750657, AD750667, AD750677, AD750687, AD750697, AD750817		Destornilladores electricistas / Electrician screwdrivers 1000V, inch		
1	AD695347		Tijera electricista / Electrician's scissors		
	AD730357		Cuchillo / Knife		
	AD660727		Buscapolos / Voltage tester		



COD.	PCS.		L x W (mm)	Medidas en / Sizes in / Mesures en	
<b>AD500467</b>	12		51025, 51039, 50950, 51045, 51478, 50977, 50954, 51560, 51562, 51075, 51040	mm	4,1
PCS./UN.	Composición / Composition / Composition		Descripción / Description / Description		
7	AD766217, AD766227, AD766237, AD766247, AD766257, AD766267, AD766277		Destornilladores electricistas / Electrician screwdrivers 1000V, mm		
5	AD659167, AD650767, AD650777, AD650797, AD650807		Llave de carraca para estructura metálica / Podging wrench mm		



COD.	PCS.		L x W (mm)	Medidas en / Sizes in / Mesures en	
<b>AD500667</b>	10		51074	1220 x 490	17,5
PCS./UN.	Composición / Composition / Composition		Descripción / Description / Description		
1	AD632627		Palanca de encofrador / Wrecking bar		
2	AD611157		Llaves ajustables / Adjustable wrenches		
	AD610267		Llave de aluminio / Aluminium pipe wrench		
	AD705047		Maceta octogonal antichispa Cu-Be / Cu-Be Non sparking sledge hammer		
1	AD696877		Martillo de ebanista / Joiner's hammer		
	AD697057		Martillo de bola / Ball pein hammer		
2	AD696687, AD696697		Maceta cuadrada tipo alemán / German type stoning hammer		



COD.	PCS.		L x W (mm)	Medidas en / Sizes in / Mesures en	
<b>AD500657</b>	47		51074	1220 x 490	10,5
PCS./UN.	Composición / Composition / Composition		Descripción / Description / Description		
2	AD638787, AD638767		Cortador con cuchilla auto-retráctil / Cutter with auto-retractable blade		
1	AD637427		Arco de sierra / Hack Saw		
4	AD634987, AD635317, AD636787, AD636757		Limas / Files		
1	AD628537		Cinzel mecánico / Flat cold chisel		
3	AD623437, AD623497, AD623417		Alicates / Pliers		
	AD622477, AD622417, AD622437		Alicates mini / Mini Pliers		
1	AD626277		Alicate trenzador de alambre reversible / Reversible Wire twist plier		
	AD620977		Tenaza Grip / Grip plier		
2	AD611127		Llaves ajustables / Adjustable wrenches		
1	AD697077		Martillo de bola / Ball pein hammer		
	AD610157		Llave heavy duty / Heavy Duty pipe wrench		
20	AD614957, AD614967		Juego llaves Allen bola / Set of hexagonal key wrenches ball type		
	AD655707		Galgas de espesores 32 hojas / Precision feeler gauge 32 blades		
	AD671957		Rasqueta para juntas / Gasket scraper		
	AD651587		Nivel magnético torpedo / Torpedo Magnetic level		
1	AD695347		Tijera electricista / Electrician's scissors		
	AD653587		Flexómetro Robust Bimat / Robust Bimat Measuring tape		
	AD586417		Linterna mini / Mini flashlight		
	AD660737		Buscapolos / Voltage tester		



• Para más información de dimensiones y características del producto, consultar en el capítulo correspondiente del catálogo general o en [www.egamaster.com](http://www.egamaster.com). / For more details about features and dimensions of the products, check the corresponding chapter of the General Catalogue or [www.egamaster.com](http://www.egamaster.com). / Pour plus d'informations sur les dimensions et les caractéristiques du produit, consulter le chapitre correspondant de notre catalogue général ou sur [www.egamaster.com](http://www.egamaster.com).



COD.	PCS.		L x W (mm)	Medidas en / Sizes in / Mesures en	
<b>AD500677</b>	34	51074	930 x 490	mm	8,5

PCS./UN.	Composición / Composition / Composition	Descripción / Description / Description	
11	AD664387, AD664397, AD664407, AD664417, AD664567, AD664727, AD664587, AD664597, AD664607, AD665257, AD665267	Destornilladores / Screwdrivers	-
6	AD751567, AD751587, AD751597, AD752017, AD752027, AD752037	Destornilladores mini / Mini screwdrivers	1000V
12	AD607707, AD607717, AD607727, AD607737, AD607747, AD607757, AD607777, AD607787, AD607797, AD607807, AD607817, AD607827	LLave de estrella plana / Double ended flat ring spanner	mm
5	AD607857, AD607887, AD607897, AD607907, AD607927	LLave para racores / Flare nut	-



COD.	PCS.		L x W (mm)	Medidas en / Sizes in / Mesures en	
<b>AD500687</b>	26	51074	870 x 490	mm/inch	8,5

PCS./UN.	Composición / Composition / Composition	Descripción / Description / Description	
17	AD603407, AD603417, AD603427, AD603437, AD603447, AD603457, AD603477, AD603487, AD603497, AD603517, AD603527, AD603537, AD603547, AD603557, AD603567, AD603577, AD603587	Llaves combinadas / Combination wrenches	inch
9	AD664007, AD664017, AD664037, AD664047, AD664067, AD664087, AD664097, AD664497, AD664107	Destornilladores mecánicos / Slotted screwdrivers	mm

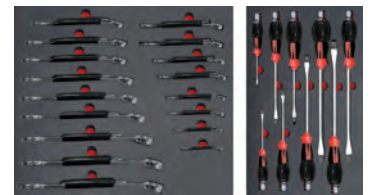

COD.	PCS.		L x W (mm)	Medidas en / Sizes in / Mesures en	
<b>AD500697</b>	20	51074	870 x 490	mm	5,5

PCS./UN.	Composición / Composition / Composition	Descripción / Description / Description	
11	AD665107, AD665117, AD665127, AD665137, AD665147, AD665157, AD665167, AD665177, AD665187, AD665197, AD665207	Destornillador de vaso / Socket screwdriver	mm
9	AD613017, AD613027, AD613037, AD613047, AD613057, AD613067, AD613087, AD613097, AD613107	Llave vaso doble articulación / Double ended swivel wrench	-



COD.	PCS.		L x W (mm)	
<b>AD500717</b>	23	51074	870 x 490	3

PCS./UN.	Composición / Composition / Composition	Descripción / Description / Description	
6	66112, 66108	Cordón anticaída con mosquetón / Carabiner lanyard	-
	66113, 66109	Cordón anticaída de nudo / Loop lanyard	-
1	AD765847	Alicates / Pliers	1000V
	AD766177	Alicates Mastercut / Mastercut Pliers	
	AD730047	Tenaza de canal / Box joint	
2	50998, 50999	Accesorio de anillas para el cinturón portaherramientas / Accessory with rings for tools belt	
3	66078	Cordón anticaída retráctil / Retractable lanyard	-
	66064	Accesorio cordón anticaída retráctil con mosquetón / Retractable lanyard with carabiner accessory	



COD.	PCS.		L x W (mm)	
<b>AD500707</b>	9	51074	870 x 490	3,5

PCS./UN.	Composición / Composition / Composition	Descripción / Description / Description	
8	AD659167, AD650767, AD659177, AD650777, AD650787, AD650797, AD650807, AD650817	Llave de carraca para estructura metálica / Podging wrench	mm
1	50997	Cinturón portaherramientas / Tool belt	





COD.	PCS.		L x W (mm)	Medidas en / Sizes in / Mesures en	
<b>AD500727</b>	12	51074	1220 x 490	mm	4

PCS./UN.	Composición / Composition / Composition	Descripción / Description / Description	
8	AD659167, AD650767, AD659177, AD650777, AD650787, AD650797, AD650807, AD650817	Llave de carraca para estructura metálica / Podging wrench	mm
4	AD624967, AD624987, AD623507, AD622997	Alicates / Pliers	-



COD.	PCS.		L x W (mm)	
<b>AD500737</b>	11	51074	930 x 490	8

PCS./UN.	Composición / Composition / Composition	Descripción / Description / Description	
2	AD610247	Llave de aluminio / Aluminium pipe wrench	
	AD610157	Llave heavy duty / Heavy Duty pipe wrench	
1	AD626277	Alicate trenzador de alambre reversible / Reversible Wire twist plier	
	AD620917	Alicate tipo Ford / Slip joint plier	
	AD620977	Tenaza Grip / Grip plier	
2	AD621067	Tenaza pico de loro / Groove joint plier	
2	AD696877, AD696847	Martillo de ebanista / Joiner's hammer	
1	AD697047	Martillo de bola / Ball pein hammer	



COD.	PCS.		L x W (mm)	
<b>AD500747</b>	21	51074	930 x 490	7

PCS./UN.	Composición / Composition / Composition	Descripción / Description / Description	
16	AD603407, AD603417, AD603427, AD603437, AD603447, AD603457, AD603477, AD603487, AD603497, AD603517, AD603527, AD603537, AD603547, AD603557, AD603567, AD603587	Llaves combinadas / Combination wrenches	inch
5	AD607857, AD607887, AD607897, AD607907, AD607927	Llave para racores / Flare nut	-



COD.	PCS.		L x W (mm)	Medidas en / Sizes in / Mesures en	
<b>AD500757</b>	9	51074	930 x 490	inch	13

PCS.	Composición / Composition / Composition	Descripción / Description / Description	
9	AD609577, AD609587, AD609617, AD609597, AD609627, AD608977, AD608987, AD608997, AD609607	Llaves combinadas / Combination wrenches	inch



COD.	PCS.		L x W (mm)	Medidas en / Sizes in / Mesures en	
<b>AD500767</b>	20	51074	930 x 490	mm	7

PCS./UN.	Composición / Composition / Composition	Descripción / Description / Description	
9	AD613017, AD613027, AD613037, AD613047, AD613057, AD613067, AD613087, AD613097, AD613107	Llave vaso doble articulación / Double ended swivel wrench	
11	AD607707, AD607717, AD607727, AD607737, AD607747, AD607757, AD607767, AD607787, AD607797, AD607807, AD607827	Llave de estrella plana / Double ended flat ring spanner	mm



COD.	PCS.		L x W (mm)	Medidas en / Sizes in / Mesures en	
<b>AD500777</b>	20	51074	1220 x 490	mm	10

PCS./UN.	Composición / Composition / Composition	Descripción / Description / Description	
14	AD766217, AD766237, AD766257, AD766277, AD767387, AD766307, AD766317	Destornilladores / Screwdrivers	
4	AD765517, AD765537	Llaves ajustables / Adjustable wrenches	1000V
2	AD730097, AD730087	Tenazas cortables / Cable cutters	



• Para más información de dimensiones y características del producto, consultar en el capítulo correspondiente del catálogo general o en [www.egamaster.com](http://www.egamaster.com). / For more details about features and dimensions of the products, check the corresponding chapter of the General Catalogue or [www.egamaster.com](http://www.egamaster.com). / Pour plus d'informations sur les dimensions et les caractéristiques du produit, consulter le chapitre correspondant de notre catalogue général ou sur [www.egamaster.com](http://www.egamaster.com).



COD.	PCS.		L x W (mm)	Medidas en / Sizes in / Mesures en	
<b>AD500787</b>	20	51074	930 x 490	mm/inch	5,5

PCS./UN.	Composición / Composition / Composition	Descripción / Description / Description	
18	AD746987, AD746997, AD747007, AD747017, AD747027, AD747037, AD747047, AD747057, AD747067, AD747077, AD747087, AD747097, AD747107, AD747117, AD747127, AD747137, AD747147, AD747157	Destornilladores / Screwdrivers	1000V
2	AD730357, AD730367	Cuchillos / Knives	



COD.	PCS.		L x W (mm)	Medidas en / Sizes in / Mesures en	
<b>AD500797</b>	15	51074	870 x 490	mm/inch	4

PCS./UN.	Composición / Composition / Composition	Descripción / Description / Description	
15	AD766207, AD766227, AD766267, AD766287, AD766327, AD766337, AD766347, AD766357, AD766367, AD766377, AD749847, AD749857, AD749877, AD749887, AD749897	Destornilladores / Screwdrivers	1000V

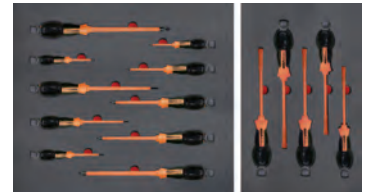

COD.	PCS.		L x W (mm)	Medidas en / Sizes in / Mesures en	
<b>AD500807</b>	15	51074	870 x 490	inch	6

PCS./UN.	Composición / Composition / Composition	Descripción / Description / Description	
2	AD730017	Tenaza de pico de loro / Groove joint pincer	1000V
4	AD730297, AD730307	Arco de sierra / Hack Saw	
7	AD765957, AD765837	Alicates / Pliers	
7	AD664397, AD664417, AD664427, AD664407, AD664437, AD553607, AD553617	Destornilladores / Screwdrivers	-



COD.	PCS.		L x W (mm)	Medidas en / Sizes in / Mesures en	
<b>AD500817</b>	27	51074	870 x 490	mm	3

PCS./UN.	Composición / Composition / Composition	Descripción / Description / Description	
6	66112, 66108	Cordón anticaída con mosquetón / Carabiner lanyard	-
	66113, 66109	Cordón anticaída de nudo / Loop lanyard	
	66078	Cordón anticaída retráctil / Retractable lanyard	
1	66062	Cordón anticaída retráctil con mosquetón / Retractable lanyard with carabiner	
2	50998, 50999	Accesorio de anillas para el cinturón portaherramientas / Accessory with rings for tools belt	
5	AD668517, AD668507, AD668527, AD668467, AD668487	Destornilladores mini / Mini screwdrivers	
4	AD636757, AD635317, AD636037, AD636397	Limas / Files	
1	AD586417	Linterna mini / Mini flashlight	
	AD660737	Buscapolos / Voltage tester	



COD.	PCS.		L x W (mm)	
<b>AD500827</b>	27	51074	870 x 490	3,5

PCS./UN.	Composición / Composition / Composition	Descripción / Description / Description	
	50997	Cinturón portaherramientas / Tool belt	-
	AD651587	Nivel magnético torpedo / Torpedo Magnetic level	
1	AD638767	Cortador con cuchilla auto-retráctil / Cutter with auto-retractable blade	
	AD623497	Alicates / Pliers	
	AD625007	Alicates Mastercut / Mastercut Pliers	
	AD695347	Tijera electricista / Electrician's scissors	
20	AD614957, AD614967	Juego llaves Allen bola / Set of hexagonal key wrenches ball type	
1	AD653587	Flexómetro Robust Bimat / Robust Bimat Measuring tape	



03

HERRAMIENTAS ANTI-CAÍDA ANTIDROP  
 ANTIDROP TOOLS  
 OUTILS ANTI-CHUTE ANTIDROP  
 ANTIDROP WERKZEUG-SICHERUNG  
 UTENSILI ANTI-CADUTA ANTIDROP  
 FERRAMENTAS ANTI-QUEDA ANTIDROP  
 ПРОТИВОУДАРНЫЕ ИНСТРУМЕНТЫ



Management System  
 ISO 9001:2015  
 ISO 14001:2015  
 www.tov.com  
 ID 091098046



ACO

JUEGOS DE HERRAMIENTAS ANTI-CAÍDA ANTIDROP / ANTIDROP TOOLS SETS / SETS OUTILS ANTI-CHUTE ANTIDROP / ANTIDROP WERKZEUGSICHERUNG / KIT DI  
 UTENSILI ANTI-CADUTA ANTIDROP / JOGO DE FERRAMENTA ANTI-QUEDA ANTIDROP / ПРОТИВОУДАРНЫЕ ИНСТРУМЕНТЫ

68 PCS.



COD.	PCS.		N.º	Composición / Composition / Composition	Medidas en / Sizes in / Mesures en	
AD500327	68	51039	7	AD500207, AD500217, AD500407, AD00427, AD500257, AD500267, AD500297	mm	90,2

62 PCS.

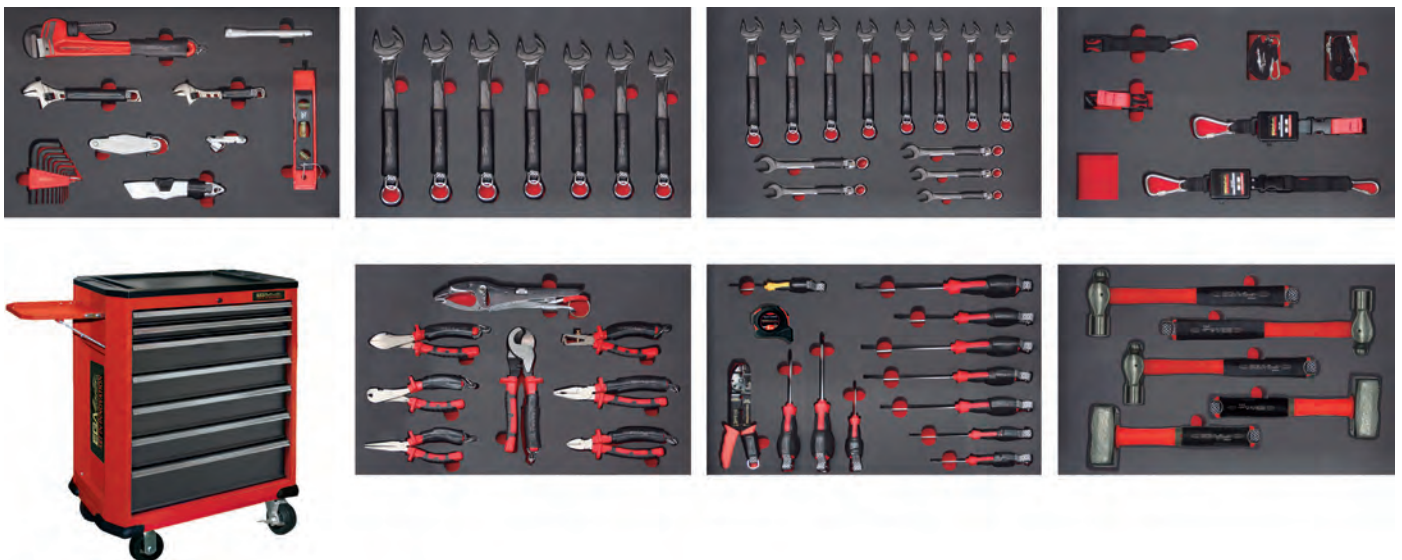

COD.	PCS.		N.º	Composición / Composition / Composition	Medidas en / Sizes in / Mesures en	
AD500337	62	51039	7	AD500207, AD500227, AD500417, AD500427, AD500257, AD500437, AD500297	inch	89,5

• Para más información de dimensiones y características del producto, consultar en el capítulo correspondiente del catálogo general o en [www.egamaster.com](http://www.egamaster.com). / For more details about features and dimensions of the products, check the corresponding chapter of the General Catalogue or [www.egamaster.com](http://www.egamaster.com). / Pour plus d'informations sur les dimensions et les caractéristiques du produit, consulter le chapitre correspondant de notre catalogue général ou sur [www.egamaster.com](http://www.egamaster.com).

Si no encuentra el artículo que necesita, consúltenos en [info@egamaster.com](mailto:info@egamaster.com) o en [www.egamaster.com](http://www.egamaster.com)  
 If you can't find the item you look for, please ask us in [info@egamaster.com](mailto:info@egamaster.com) or in [www.egamaster.com](http://www.egamaster.com)  
 Si vous ne trouvez pas l'article que vous désirez, consultez-nous a [info@egamaster.com](mailto:info@egamaster.com) ou a [www.egamaster.com](http://www.egamaster.com)

**EGA Master**  
 ART IN INNOVATION

131

# 03

**HERRAMIENTAS ANTI-CAÍDA ANTIDROP**  
**ANTIDROP TOOLS**  
**OUTILS ANTI-CHUTE ANTIDROP**  
**ANTIDROP WERKZEUG-SICHERUNG**  
**UTENSILI ANTI-CADUTA ANTIDROP**  
**FERRAMENTAS ANTI-QUEDA ANTIDROP**  
**ПРОТИВОУДАРНЫЕ ИНСТРУМЕНТЫ**



64 PCS.



COD.	PCS.		N.º	Composición / Composition / Composition	Medidas en / Sizes in / Mesures en	
AD500347	64	51039	7	AD500287, AD500237, AD500467, AD500427, AD500257, AD500267, AD500277	mm	89,7

58 PCS.



COD.	PCS.		N.º	Composición / Composition / Composition	Medidas en / Sizes in / Mesures en	
AD500357	58	51039	7	AD500447, AD500247, AD500457, AD500427, AD500257, AD500437, AD500277	inch	90,1



# 03

**HERRAMIENTAS ANTI-CAÍDA ANTIDROP**  
**ANTIDROP TOOLS**  
**OUTILS ANTI-CHUTE ANTIDROP**  
**ANTIDROP WERKZEUG-SICHERUNG**  
**UTENSILI ANTI-CADUTA ANTIDROP**  
**FERRAMENTAS ANTI-QUEDA ANTIDROP**  
**ПРОТИВОУДАРНЫЕ ИНСТРУМЕНТЫ**



**ACO**



COD.	PCS.		N.º	Composición / Composition / Composition	Medidas en / Sizes in / Mesures en	
AD500377	58	51039	7	AD500207, AD500417, AD500257, AD500427, AD500317, AD500457, AD500297	inch	90,9

■ 73 PCS.

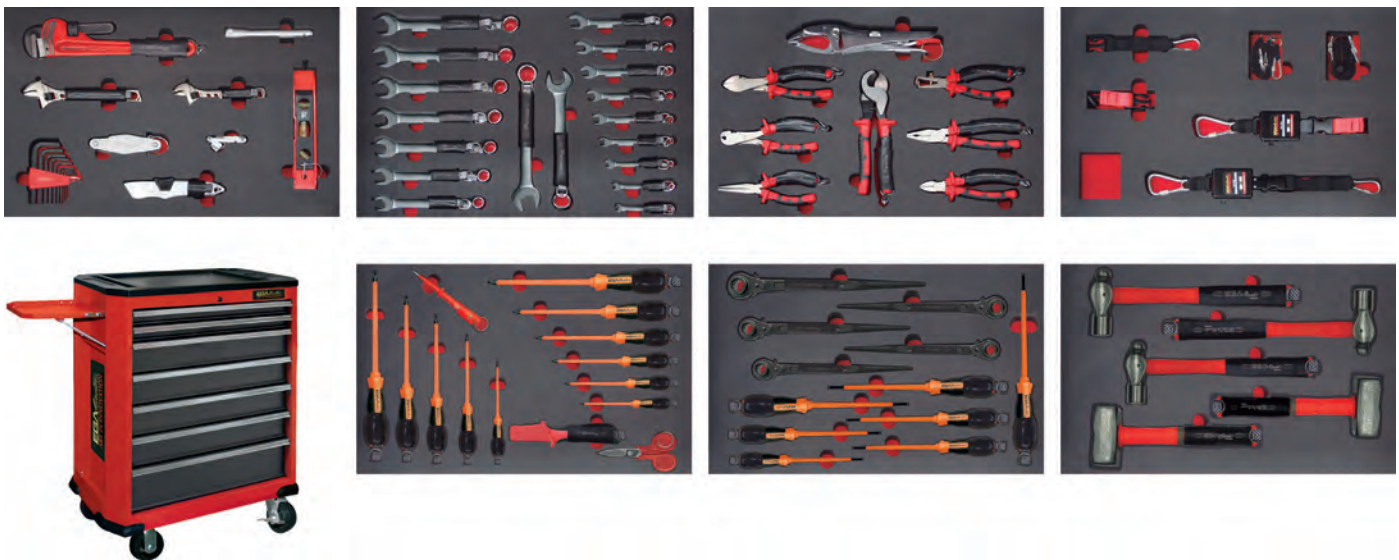

COD.	PCS.		N.º	Composición / Composition / Composition	Medidas en / Sizes in / Mesures en	
AD500367	73	51039	7	AD500207, AD500407, AD500257, AD500427, AD500307, AD500467, AD500297	mm	92,5

• Para más información de dimensiones y características del producto, consultar en el capítulo correspondiente del catálogo general o en [www.egamaster.com](http://www.egamaster.com). / For more details about features and dimensions of the products, check the corresponding chapter of the General Catalogue or [www.egamaster.com](http://www.egamaster.com). / Pour plus d'informations sur les dimensions et les caractéristiques du produit, consulter le chapitre correspondant de notre catalogue général ou sur [www.egamaster.com](http://www.egamaster.com).

Si no encuentra el artículo que necesita, consúltenos en [info@egamaster.com](mailto:info@egamaster.com) o en [www.egamaster.com](http://www.egamaster.com)  
 If you can't find the item you look for, please ask us in [info@egamaster.com](mailto:info@egamaster.com) or in [www.egamaster.com](http://www.egamaster.com)  
 Si vous ne trouvez pas l'article que vous désirez, consultez-nous a [info@egamaster.com](mailto:info@egamaster.com) ou a [www.egamaster.com](http://www.egamaster.com)



# 03

**HERRAMIENTAS ANTI-CAÍDA ANTIDROP**  
**ANTIDROP TOOLS**  
**OUTILS ANTI-CHUTE ANTIDROP**  
**ANTIDROP WERKZEUG-SICHERUNG**  
**UTENSILI ANTI-CADUTA ANTIDROP**  
**FERRAMENTAS ANTI-QUEDA ANTIDROP**  
**ПРОТИВОУДАРНЫЕ ИНСТРУМЕНТЫ**



169 PCS.

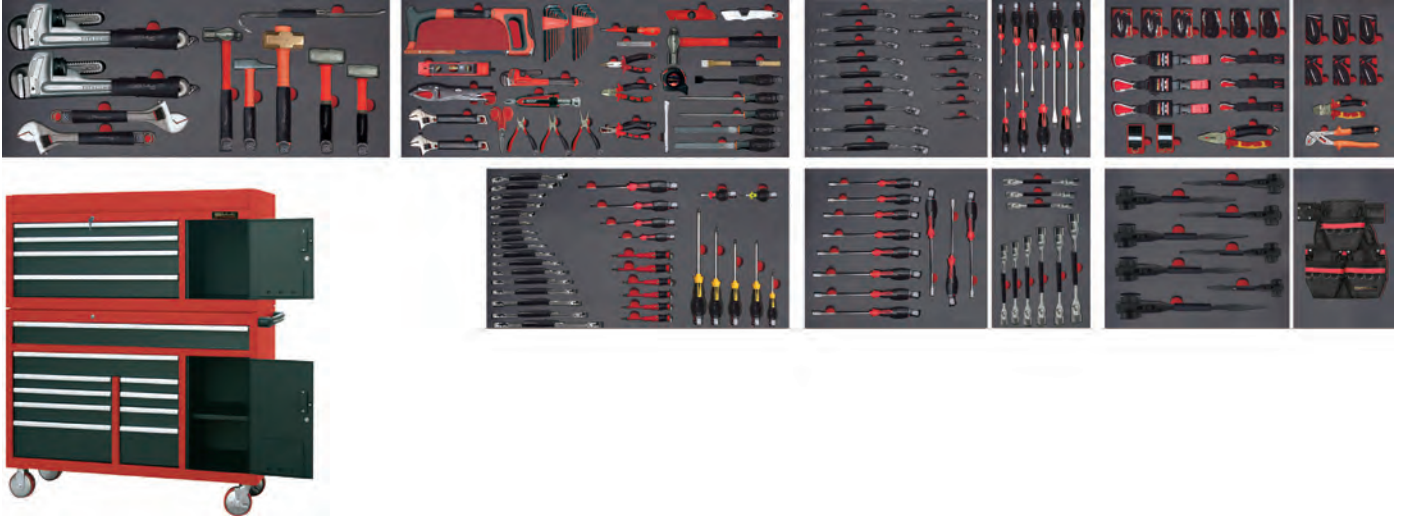

COD.	PCS.		N.º	Composición / Composition / Composition	Medidas en / Sizes in / Mesures en	
AD500387	169	51074	7	AD500657, AD500667, AD500677, AD500687, AD500697, AD500707, AD500717	mm/inch	298

197 PCS.

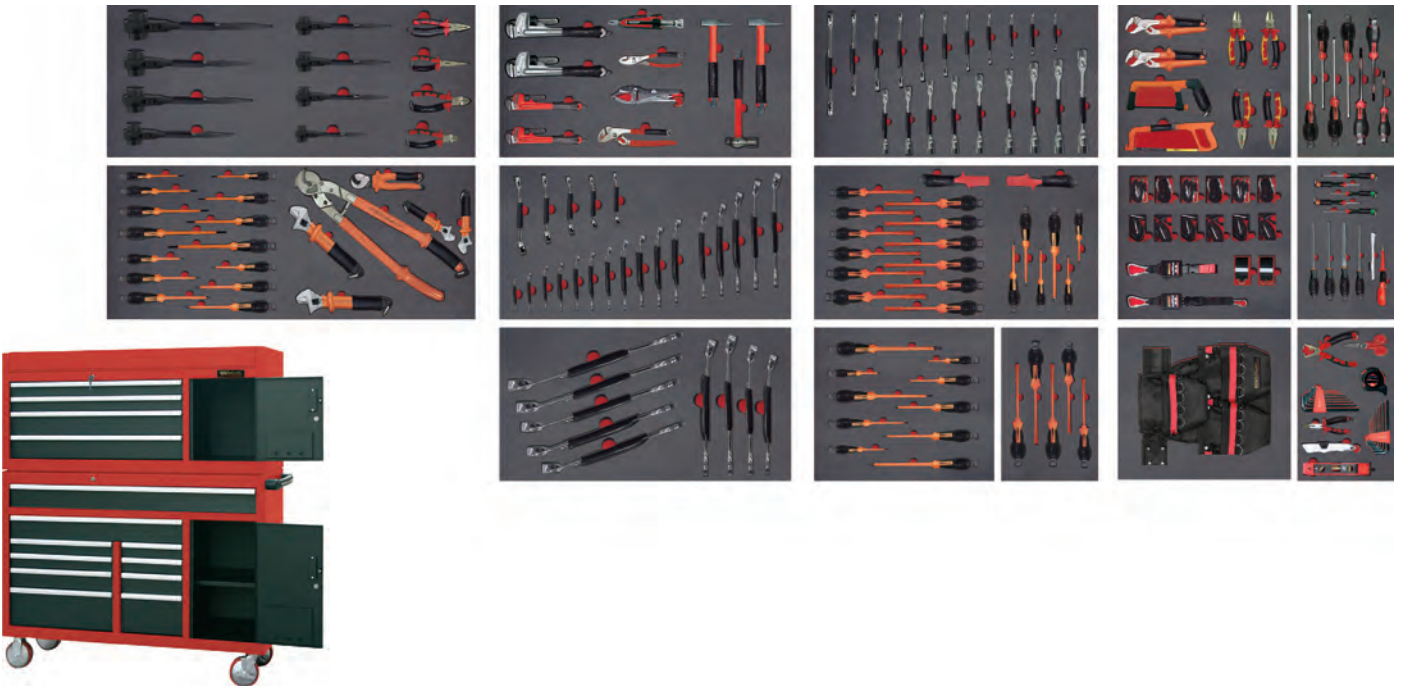

COD.	PCS.		N.º	Composición / Composition / Composition	Medidas en / Sizes in / Mesures en	
AD500397	197	51074	11	AD500727, AD500737, AD500747, AD500757, AD500767, AD500777, AD500787, AD500797, AD500807, AD500817, AD500827	mm/inch	303





# 1000V NON-SPARKING

ANTICHISPA AISLADA 1000V  
1000V INSULATED NON-SPARKING  
ANTI-DÉFLAGRANT ISOLÉ 1000V  
1000V FUNKENFREI  
ANTISCINTILLA 1000V ISOLATA  
FERRAMENTA ANTI-CHISPA ISOLADA 1000V  
1000В ИСКРОБЕЗОПАСНЫЙ

# 4



N-S 1000V

Existen áreas de trabajo en las que los trabajadores se exponen a la combinación de varios factores de riesgo en lo que a seguridad y salud se refiere: los trabajos bajo tensión eléctrica dentro de entornos que presenten algún tipo de agente explosivo (como, por ejemplo, gases o polvos). Esta situación puede darse, por ejemplo, en las siguientes aplicaciones:

- Fabricación de pila/baterías.
- Mantenimiento y reparación de baterías.
- Mantenimiento eléctrico en zonas ATEX.

Esta gama proporciona herramientas aisladas certificadas de acuerdo a la norma internacional IEC 60900, asegurando al mismo tiempo propiedades anti-chispa para zonas clasificadas como ATEX. En cuanto a dimensiones y diseño son idénticas a las herramientas de gran calidad de la gama anti-chispa de **EGA Master**, pero con el aislamiento necesario y adecuado para poder trabajar bajo tensión, por lo que se mantienen tanto las propiedades mecánicas como las de seguridad. Fabricadas en Al-Br y Cu-Be, ambas aleaciones están certificadas por el Instituto Federal Alemán BAM, acreditado por la Unión Europea para la aprobación de productos dirigidos a ambientes con riesgo de explosión.



*Certain working areas show 2 different health and safety risks: they show voltage tension, while the environment may have an explosive agent present (such as gases or dusts). Such areas may appear in:*

- Manufacturing of batteries
- Battery repair and maintenance
- Electrical maintenance in ATEX areas.

*The EGA Master Non-sparking 1000V insulated tool range provides safe insulated tools, certified according to international IEC 60900 standard, while assuring total non-sparking properties for ATEX classified areas. Tools are exactly the same shape and design as the high-quality EGA Master non-sparking tools, but with the necessary and adequate insulation for jobs under voltage. Manufactured in Al-Br or Cu-Be, both alloys are certified by the German Federal BAM Institution, accredited by the European Union for the approval of products to be used in explosion hazard environments.*

Ils existent des zones de travail dans lesquels les travailleurs s'exposent à divers facteurs risque, en termes de sécurité et de santé: les travaux sous tension électrique situés dans des environnements qui présentent un certain type d'agent explosif (comme par exemple les gaz ou la poussière). Cette situation peut se dérouler, par exemple, dans les applications suivantes:

- Fabrication de pile/batteries
- Maintenance et réparation de batteries
- Maintenance électrique en zones ATEX

Cette gamme fournit des outils isolés certifiés conforme à la norme internationale IEC 60900, fournissant également des propriétés anti-déflagrantes pour les zones classifiées ATEX. Quant aux dimensions et au design, ils sont identiques aux outils de grande qualité de la gamme antidéflagrante d'**EGA Master**, mais avec l'isolation nécessaire et adéquate pour travailler sous tension, raison pour laquelle autant les propriétés mécaniques que de sécurité sont préservées. Fabriqués en Al-Br et Cu-Be, les deux alliages sont certifiés par l'Institut Fédéral Allemand BAM, accrédité par l'Union Européenne pour l'agrément des produits destinés aux environnements avec risque d'explosion.

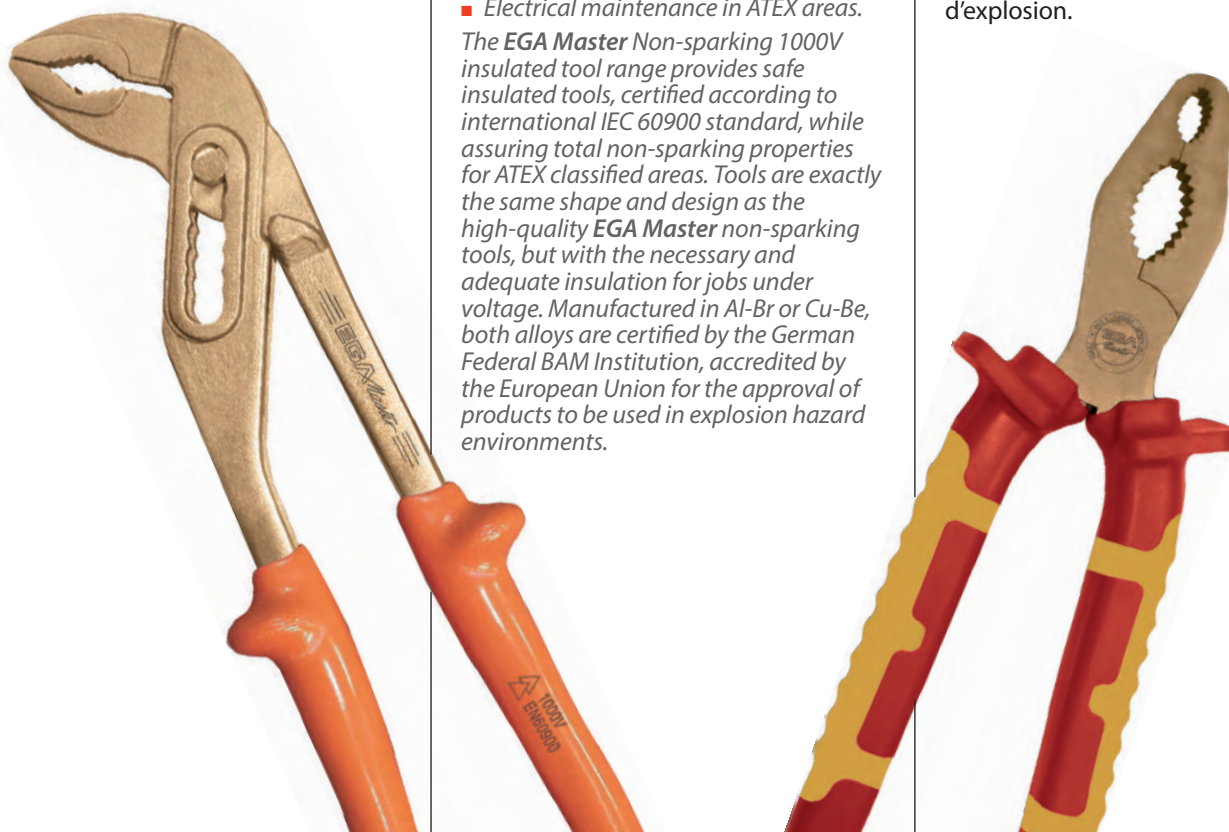

■ **ALICATES / PLIERS / PINCES / ZANGEN / PINZE / ALICATES / ПЛОСКОГУБЦЫ**

■ **UNIVERSALES / COMBINATION / UNIVERSELLES / KOMBIZANGEN / UNIVERSALE / UNIVERSAIS / КОМБИНИРОВАННЫЕ**

COD.	MAT.	COD.	MAT.	L (mm)	g
79030		79031		160	250
79032	Cu-Be	79033	Al-Bron	180	320
76240		76241		200	370

⚠ 1000V | IEC 60900 | Modelo registrado / Registered model / Modèle enregistré

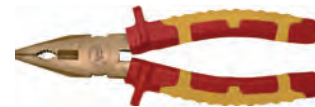

■ **BOCA REDONDA / ROUND NOSE / BECS RONDS / RUNDZANGEN / ВЕСЧИ TONDI / PONTAS REDONDAS / КРУГЛОГУБЦЫ**

COD.	MAT.	COD.	MAT.	L (mm)	g
79036	Cu-Be	79037	Al-Bron	160	160

⚠ 1000V | IEC 60900 | Modelo registrado / Registered model / Modèle enregistré



■ **TELEFONISTA / LONG NOSE / TELEPHONE / TELEFONZANGEN / TELEFONISTI / TELEFONISTA / С УДЛИННЕННЫМИ НОСАМИ**

COD.	MAT.	COD.	MAT.	L (mm)	g
79038		79039		160	250
79040	Cu-Be	79041	Al-Bron	180	270
76242		76243		200	370

⚠ 1000V | IEC 60900 | Modelo registrado / Registered model / Modèle enregistré



■ **CORTE DIAGONAL / DIAGONAL CUTTING PLIERS / COUPANTES DIAGONALES / KRAFTSEITENSCHNEIDER / TAGLIO LATERALE / CORTE DIAGONAL / БОКОРЕЗЫ**

COD.	MAT.	COD.	MAT.	L (mm)	g
79042	Cu-Be	79043	Al-Bron	160	250

⚠ 1000V | IEC 60900 | Modelo registrado / Registered model / Modèle enregistré



■ **CORTE DIAGONAL REFORZADO / HEAVY DUTY CUTTING NIPPERS / COUPANTES RENFORCEÉS / VERSTÄRKTER SEITENSCHNEIDER / TAGLIO LATERALE RINFORZATO / CORTE DIAGONAL REFORÇADO / УСИЛЕННЫЕ БОКОРЕЗЫ**

COD.	MAT.	COD.	MAT.	L (mm)	g
79044	Cu-Be	79045	Al-Bron	160	260
79046		79047		180	320

⚠ 1000V | IEC 60900 | Modelo registrado / Registered model / Modèle enregistré



■ **ALICATE GASISTA / GAS PIPE PLIERS / PINCE GAZIER / ROHRZANGE / PINZA PER GASISTA / ALICATE PARA TUBO DE GAZ / КЛЕЩИ ГАЗОВЫЕ**

COD.	MAT.	COD.	MAT.	L (mm)	g
79048	Cu-Be	79049	Al-Bron	210	370

⚠ 1000V | IEC 60900 | Modelo registrado / Registered model / Modèle enregistré



■ **ALICATE TIPO FORD / SLIP JOINT PLIER / PINCE MOTORISTE / MECHANIKERZANGE / PINZE PER GASISTI / ALICATE MOTORISTA / СКОЛЬЗЯЩИЕ КЛЕЩИ**

COD.	MAT.	COD.	MAT.	L (inch)	g
79050	Cu-Be	79051	Al-Bron	8	250

⚠ 1000V | IEC 60900 | Modelo registrado / Registered model / Modèle enregistré



■ **RELACABLES / WIRESTRIPPER / PINCES À DÉNUDER / ABISOLIERZANGEN / PINZE SPELAFILI / DECAPADORES / КЛЕЩИ ДЛЯ ЗАЧИСТКИ КОНТАКТОВ**

COD.	MAT.	COD.	MAT.	L (mm)	g
79052	Cu-Be	79053	Al-Bron	170	220

⚠ 1000V | IEC 60900 | Modelo registrado / Registered model / Modèle enregistré



**Cu-Be** Cobre berillo / Beryllium copper / Cuivre beryllium / Kupfer beryllium / Koper beryllium / Rame-berillio / Сплав Медь Бериллий  
**Al-Bron** Aluminio bronce / Aluminium bronze / Alliage aluminium-bronze / Alliage aluminium-bronze / Aluminium brons / Aluminio bronz / Сплав Алюминий Бронза

# 04

**ANTICHISPA AISLADA 1000V**  
**1000V INSULATED NON-SPARKING**  
**ANTIDÉFLAGRANT ISOLÉ 1000V**  
**1000V FUNKENFREI**  
**ANTISCINTILLA 1000V ISOLATA**  
**FERRAMENTA ANTI-CHISPA ISOLADA 1000V**  
**1000В ВЫСОКОВОЛЬТНЫЙ ИСКРБЕЗОПАСНЫЙ ИНСТРУМЕНТ**



**TENAZA DE CANAL / BOX JOINT / MULTIPRISE ENTREPASSÉE / WASSERPUMPENZANGE / PINZE REGOLABILI / BICO DE PAPAGAIO / ШАРНИРНЫЕ**

COD.	MAT.	COD.	MAT.	L (inch)	g
79358	Cu-Be	79359	Al-Bron	10	350



⚠️ 1000V | IEC 60900

**LLAVE AJUSTABLE / ADJUSTABLE WRENCH / CLÉ À MOLETTE / ROLLGABELSCHLÜSSEL / CHIAVI REGOLABILI A RULLINO / CHAVE AJUSTAVEL / РАЗВОДНЫЕ КЛЮЧИ**

COD.	MAT.	COD.	MAT.	L (inch)	AF mm	g
79361	Cu-Be	79363	Al-Bron	8	25	330
79362		10		30	550	



⚠️ 1000V

**DESTORNILLADORES / SCREWDRIVERS / TOURNEVIS / SCHRAUBENZIEHER / CACCIAVITI / CHAVES DE FENDA / ОТВЕРТКИ**

**MECÁNICO / SLOTTED / MECANICIEN / FÜR SCHLITZSCHRAUBEN / PER MECCANICI / PHILIPS**  
**MECÁNICO / ПЛОСКАЯ**



COD.	MAT.	COD.	MAT.	⌀	g
79155	Cu-Be	79156	Al-Bron	3 x 75	35
72227		4 x 100		60	
79157		5 x 100		75	
79159		6 x 150		110	
79161		8 x 200		165	

⚠️ 1000V | IEC 60900



COD.	MAT.	COD.	MAT.	⊕	g
72225	Cu-Be	72224	Al-Bron	PH-0	50
79147		PH-1		75	
79149		PH-2		110	
79151		PH-3		165	
79153		PH-4		245	

⚠️ 1000V | IEC 60900

**JUEGOS ELECTRICIDAD / ELECTRICIAN SETS / SETS ÉLECTRICIENS / WERKZEUGSÄTZE FÜR ELEKTRIZITÄT / KIT ELETTRICISTI / JOGOS ÉTRICIDADE / НАБОР ЭЛЕКТРИКА**

■ 13 PCS.



COD.	PCS.	⊞	MAT.	Kg
79087	13	51054	Cu-Be	5,7

COD. PCS.	Descripción / Description / Description	
76240	Alicate universal / Combination pliers	
79042	Alicate corte diagonal / Diagonal cutting plier	-
79052	Pelacables / Wirestripper	
79362	Llave ajustable / Adjustable wrench	10"
79358	Tenaza de canal / Box joint	
79147	Destornilladores / Screwdrivers	PH1
79149		PH2
79151		PH3
79155		3 x 75 mm
72227		4 x 100 mm
79157		5 x 100 mm
79159		6 x 150 mm
79161		8 x 200 mm



COD.	PCS.	⊞	MAT.	Kg
79088	13	51054	Al-Bron	5,7

COD. PCS.	Descripción / Description / Description	
76241	Alicate universal / Combination pliers	
79043	Alicate corte diagonal / Diagonal cutting plier	-
79053	Pelacables / Wirestripper	
79364	Llave ajustable / Adjustable wrench	10"
79359	Tenaza de canal / Box joint	
79148	Destornilladores / Screwdrivers	PH1
79150		PH2
79152		PH3
79156		3 x 75 mm
72226		4 x 100 mm
79158		5 x 100 mm
79160		6 x 150 mm
79162		8 x 200 mm

**Cu-Be** Cobre berilio / Beryllium copper / Cuivre beryllium / Kupfer beryllium / Koper beryllium / Rame-berillio / Сплав Медь Бериллий  
**Al-Bron** Aluminio bronce / Aluminium bronze / Alliage aluminium-bronze / Alliage aluminium-bronze / Aluminium brons / Aluminio bronzo / Сплав Алюминий Бронза

■ **LLAVES / WRENCHES / CLÉS / SCHLÜSSEL / CHIAVI / CHAVES / КЛЮЧИ**

**FIJA DE UNA BOCA / SINGLE ENDED OPEN JAW SPANNER / À FOURCHE / EINMAULSCHLÜSSEL / FISSE SEMPLICE / FIXA DE UMA BOCA / ОДНОРОЖКОВЫЙ КЛЮЧ**



COD.	MAT.	COD.	MAT.	AF mm	L (mm)	g
79250		79277		6	90	50
79251		79278		7		
79252		79279		8	95	
79253		79280		9		
79254		79281		10	105	
79255		79282		11	110	
79256		79283		12	115	
79257		79284		13	125	
79258		79285		14	130	60
79259		79286		15	135	
79260		79287		16	140	
79261		79288		17	145	
79262	Cu-Be	79289	Al-Bron	18	155	
79263		79290		19	160	
79264		79291		20	170	80
79265		79292		21	175	95
79266		79293		22	185	110
79267		79294		23	195	160
79268		79295		24	200	
79269		79296		25	215	210
79270		79297		26	225	
79271		79298		27		
79272		79299		28	235	260
79273		79300		29	245	280
79274		79301		30	255	
79275		79302		32	275	310

⚠ 1000V | IEC 60900

**ESTRELLA DE UNA BOCA ACODADA / OFFSET SINGLE END RING WRENCH / CLÉ POLYгонаLE CONTRE-COUDÉE / EINRINGSCHLÜSSEL, GEKRÖPFT / CHIAVE A GOMITO A STELLA UNA BOCCA / CHAVE LUNETA BOCA INCLINADA / КЛЮЧ ИЗГНУТАЯ ОДИНАРНАЯ ЗВЕЗДОЧКА**



COD.	MAT.	COD.	MAT.	AF mm	L (mm)	g
79304		79331		6		35
79305		79332		7	100	
79306		79333		8		50
79307		79334		9	110	
79308		79335		10		55
79309		79336		11		60
79310		79337		12	120	80
79311		79338		13		85
79312		79339		14		100
79313		79340		15	150	
79314		79341		16		150
79315		79342		17	170	
79316	Cu-Be	79343	Al-Bron	18		210
79317		79344		19		
79318		79345		20	200	270
79319		79346		21		
79320		79347		22		
79321		79348		23	230	300
79322		79349		24		400
79323		79350		25		410
79324		79351		26	280	440
79325		79352		27		
79326		79353		28	300	530
79327		79354		29		
79328		79355		30	310	730
79329		79356		32	320	

⚠ 1000V | IEC 60900

**EGGA Master**  
**ART IN INNOVATION**

**Cu-Be** Cobre berilio / Beryllium copper / Cuivre beryllium / Kupfer beryllium / Koper beryllium / Rame-berillio / Сплав Медь Бериллий  
**Al-Bron** Aluminio bronze / Aluminium bronze / Alliage aluminium-bronze / Alliage aluminium-bronze / Aluminium brons / Aluminio bronzo / Сплав Алюминий Бронза

Si no encuentra el artículo que necesita, consúltenos en [info@egamaster.com](mailto:info@egamaster.com) o en [www.egamaster.com](http://www.egamaster.com)  
 If you can't find the item you look for, please ask us in [info@egamaster.com](mailto:info@egamaster.com) or in [www.egamaster.com](http://www.egamaster.com)  
 Si vous ne trouvez pas l'article que vous desirez, consultez-nous a [info@egamaster.com](mailto:info@egamaster.com) ou a [www.egamaster.com](http://www.egamaster.com)



*Coca-Cola*

**COCA-COLA  
(Cabo Verde)**

*António Barros*  
Technical Supervisor

"We are very satisfied with the personalization by laser marking and the quality of EGA Master tools, as well as with the company's after-sales service"

**NON-SPARKING**

**ANTICHISPA**  
*NON-SPARKING*  
**ANTI-DEFLAGRANT**  
*FUNKENFREI*  
**ANTISCINTILLA**  
*ANTI-DEFLAGRANTE*  
**ИСКРОБЕЗОПАСНЫЙ**

**5**



**NON-SPARKING**

Las herramientas Antichispa **EGA Master** son la mejor alternativa para las aplicaciones en entornos de potencial explosivo. Incorporamos a nuestras herramientas antichispa todo nuestro conocimiento de décadas diseñando y fabricando herramientas de mano, ergonómicas, fáciles de usar y con el diseño más atractivo.

*EGA Master Non-Sparking Tools are the best alternative for non-sparking application purposes in potentially explosive environments. We incorporate to our non-sparking tools all our knowledge of decades designing and manufacturing hand tools, making the most ergonomic and nicest design for them.*

L'outillage anti-déflagrant **EGA Master** est la meilleure alternative pour l'application en milieux explosifs. Nous apportons notre longue expérience dans la conception et la fabrication d'outillage à main dans le domaine de l'ergonomie, de la facilité d'utilisation et du Design.

■ **MATERIALES**  
MATERIALS  
MATERIAUX

Aleación Cobre-Berilio / Copper-Beryllium Alloy / Alliage Cuivre-Béryllium		
Composición / Composition / Composition	Be	1.8 % - 2 %
	Ni+Co	0.2 % - 1.2 %
	Otros / Other / Autres	<0.5 %
	Resto / Rest / Reste	Cu
Dureza / Hardness / Dureté	283-365 Brinell	
Resistencia a la tracción / Tensile Strength / Resistance à la traction	1250 N/mm <sup>2</sup>	

Aleación Aluminio-Bronce / Aluminium-Bronze Alloy / Alliage aluminium-bronze		
Composición / Composition / Composition	Al	10 % - 12 %
	Ni	4 % - 6 %
	Fe+Mn	<5.8 %
	Otros / Other / Autres	<0.5 %
	Resto / Rest / Reste	Cu
Dureza / Hardness / Dureté	229-291 Brinell	
Resistencia a la tracción / Tensile Strength / Resistance à la traction	800 N/mm <sup>2</sup>	

■ **NOTA IMPORTANTE / IMPORTANT NOTE / AVIS IMPORTANT**

Por sus características especiales de dureza y resistencia (sensiblemente inferiores a los que se pueden obtener en herramientas de acero), las herramientas antichispa no pueden ser garantizadas contra ninguna deformación ni rotura. Sólo se repondrán en concepto de garantía aquellas herramientas antichispa cuya dureza Brinell sea inferior (o exceda) a la indicada en nuestro catálogo: 283-365 Brinell en el caso de las fabricadas en Cobre-Berilio y 229-291 Brinell en las fabricadas en Aluminio Bronce.

*The hardness and resistance that can be achieved with the materials used to manufacture non-sparking tools is significantly lower than that which can be obtained in tools made of steel. Due to these special characteristics of the material employed, non-sparking tools can not be guaranteed against any deformation or breakage. Non-sparking tools will be replaced under guarantee only when the hardness of the damaged tool does not reach (or exceeds) the one indicated in our catalogue: 283-365 Brinell for those made in Copper-Beryllium and 229-291 Brinell for those made in Aluminum Bronze.*

Du fait de sa dureté et sa résistance spécifiques (sensiblement inférieures à celles d'outils en acier), les outils anti-déflagrants ne peuvent être garantis contre toute déformation ou rupture. Seulement seront pris en garantie, les outils anti-déflagrants dont la dureté est inférieure (ou excède) à celle indiquée dans notre catalogue: 283-365 Brinell pour le Cuivre - Béryllium et 229-291 Brinell pour l'Aluminium - Bronze.





■ **PROPIEDADES Y CARACTERÍSTICAS**  
**PROPERTIES AND FEATURES**  
**PROPRIÉTÉS ET CARACTÉRISTIQUES**

Propiedad / Property / Propriété	Aplicación o beneficio / Application or benefits / Application ou bienfait
Antichispa / Non-sparking / Anti-déflagrant	Apropiado para entornos de potencial explosivo / <i>Appropriate for explosive potential environments</i> / Approprié pour un environnement explosif
Seguridad anti-magnética / <i>Non-magnetic safety</i> / Sécurité anti-magnétique	Esencial para equipos que requieren una completa seguridad no magnética / <i>Essential for equipments that require complete non-magnetic safety</i> / Essentiel pour des équipements qui nécessitent une complète sécurité, sauf magnétique
Resistente a la corrosión / <i>Corrosion resistant</i> / Résistant à la corrosion	Especialmente concebidos para aplicaciones en entornos corrosivos como pueden ser en trabajos en la marina o de aplicaciones de bomberos / <i>Specially well suited for applications in corrosive environments like encountered in marine works or fire-fighting applications</i> / Spécialement conçu pour des environnements corrosifs, comme des travaux en air salin ou pratiqués par les pompiers
Forjado después de la fundición / <i>Forged after casting</i> / Forgé après fonte	Proporcionan grandes propiedades mecánicas y gran acabado / <i>Provides higher mechanical properties and better finishing</i> / Cet outillage forgé a une grande résistance mécanique et une meilleure finition
Diseños Ergonómicos / <i>Ergonomic designs</i> / Formes ergonomiques	La utilización de dos materiales antideslizantes para los mangos, diseño totalmente ergonómico para hacer las operaciones más fácilmente, más rápido y confortable / <i>The use of bi-material anti-slippery handles, dipping anti-slippery handles, totally ergonomic designs make operations easier, more comfortable and master</i> / L'utilisation de deux matériaux anti-dérapants pour le manche, le design totalement ergonomique pour un travail plus aisé, plus rapide et confortable

■ **DIFERENCIAS Y ELECCIÓN DE LA OPCIÓN CORRECTA**  
**DIFFERENCES AND HOW TO MAKE THE CORRECT CHOICE**  
**DIFFÉRENCES ET SÉLECTION DE L'OPTION CORRECTE**

Concepto / Concept / Concept	Cu-Be	Al-Bron
Dureza / <i>Hardness</i> / Dureté	283-365 Brinell	229-291 Brinell
Magnetismo / <i>Magnetism</i> / Magnétisme	La ausencia férrea en la composición hace que sea más seguro cuando las aplicaciones no magnéticas son requeridas / <i>Non ferrous substance in the composition makes it safer when non-magnetic applications are required</i> / L'absence de substance ferrique dans sa composition, fait de lui un alliage plus sûr pour des utilisations non magnétiques	Mínimo componente de hierro hacen que no sea 100 % no magnético, aunque su bajo magnetismo lo hace apropiado para las aplicaciones de bajo magnetismo no críticas / <i>Minimum ferrous component makes them not 100% non-magnetic, although its low magnetism make it appropriate for non critical non-magnetic applications</i> / Le minimum de substance ferreuse fait qu'il n'est pas à 100% amagnétique, malgré tout, son faible magnétisme le rend approprié pour des travaux amagnétiques mais non critiques
Durabilidad / <i>Durability</i> / Longévité	Muy grande debido a la gran dureza y la resistencia a tracción. Grandes esfuerzos pueden ser proporcionados / <i>Much higher due to the higher hardness and tensile strength. Higher efforts can be made</i> / Grande longévité due à sa composition et à la dureté. Supporte des forces importantes	No tanto como el Cu-Be / <i>Not as much as Cu-Be</i> / Pas autant que le Cu-Be
Precio / <i>Price</i> / Prix	Gran precio debido al material especial usado / <i>Higher price due to the special raw material used</i> / Onérosité due aux matériaux spéciaux utilisés	Sobre un 30 % más bajo / <i>Around 30% lower price</i> / Approx. 30% moins cher

■ **PRECAUCIÓN**  
**CAUTION**  
**PRÉCAUTION**

Estas herramientas no están clasificadas como antiestáticas debido a que son conductoras de electricidad. No usar herramientas que contengan más de un 65 % de cobre en contacto directo con acetileno debido a la posible formación de acetilina explosiva, especialmente en presencia de humedad.

These tools are not classified as anti-static because they do conduct electricity. Do not use high copper content tools (>65%) in direct contact with acetylene due to the possible formation of explosive acetylide, specially in the presence of moisture.

Ces outils ne sont pas classifiés comme anti-statiques, car ils sont conducteurs d'électricité. Ne pas utiliser les outils composés de cuivre (>65%), en contact direct avec l'Acétylène car il y a un risque d'explosion acétylique surtout en présence d'humidité.

■ **TABLA DE RIESGOS DE EXPLOSIÓN Y MÁXIMA TEMPERATURA**  
**TABLE OF RISKS OF EXPLOSION AND MAXIMUM TEMPERATURE**  
**TABLEAU DE RISQUES D'EXPLOSION ET TEMPÉRATURE MAXIMALE**

Grupo de ignición Explosion group Groupe d'explosion	Clase de temperatura (máxima temperatura superficial admitida) Class of temperature (maximum surface temperature allowed) Classe de température maximum admise					
	T1 (450 °C)	T2 (300 °C)	T3 (200 °C)	T4 (135 °C)	T5 (100 °C)	T6 (85 °C)
Temperatura de ignición Temperature of ignition Température d'ignition	450 °C	300-450 °C	200-300 °C	135-300 °C	100-135 °C	85-100 °C
<b>I</b>	Metano Methane Méthane					
<b>IIA</b> Energía de ignición superior a: Energy of ignition higher than: Energie d'ignition supérieure á: 0.18 mJ	Acetona Acetone Acétone	i-amilacetato i-amyl acetate i-amylacétate	Amilalcohol Amyl alcohol Amyl alcool	Acetaldehído Acetaldehyde Acétaldéhyde		
	Amoníaco Ammonia Ammoniac	n-butano n-butane n-butane	Gasolinas Gasolines Gasolines			
	Benceno Benzene Benzène	n-butanol n-butanol n-butanol	Gasóleo Gas-oil Gas-Oil			
	Etilacetato Ethylacetate Acétate d'éthyle	1-buteno 1-butene 1-butène	Combustible de calefacción Heating oil Huile de chauffage			
		Propilacetato Propylacetate Acétate de propyle	n-hexano n-hexane n-hexane			
	Metanol Methanol Méthanol	i-propanol i-propanol i-propanol				
	Propano Propane Propane	Vinilclorido Vinylchloride Vinylchloride				
Tolueno Toluene Toluène						
<b>IIB</b> Energía de ignición entre: Energy of ignition between: Energie d'ignition de: 0.06 & 0.18 mJ	Cianuro de hidrógeno Hydrogen cyanide Cyanure d'hydrogène	1.3-butadieno 1.3-butadiene Buta-1.3 diène	Dimetileter Dimethyl ether Diméthyl éther	Diétiler Diethyleter Diéthyl éther		
		1.4-dioxano 1.4-dioxane 1.4-dioxane	Etiloglicol Ethyl glycol Ethyl glycol			
	Gas de carbón Coal gas (lighting gas) Gaz de houille	Etileno Ethylene Éthylène	Sulfuro de hidrógeno Hydrogen sulphide Sulfure d'hydrogène			
	Óxido de etileno Ethylene oxide Oxyde d'éthylène					
<b>IIC</b> Energía de ignición inferior a: Energy of ignition less than: Energie d'ignition inferieur á: 0.06 mJ	Hidrógeno Hydrogen Hydrogène	Acetileno Acetylene Acétylène			Disulfuro de carbono Carbon disulphide Disulfure de carbone	
	Gas de agua Water gas Gaz d'eau (CO+H2)				Nitrato de etilo Ethyl nitrate Nitrate d'éthyle	

Las herramientas fabricadas en aleación Cobre-Berilio se pueden utilizar en todos los grupos (I, IIA, IIB y IIC) de manera segura, respetando siempre la temperatura máxima de superficie, excepto para el acetileno, porque el cobre reacciona con él creando gases de acetilina altamente explosivos.

*Tools made of Cu-Be alloy can be used in all groups (I, IIA, IIB, IIC) in a safe way, always respecting the maximum surface temperature allowed, with the only exception of acetylene, with which copper might react and create highly explosive acetylide gases.*

Le cuivre Béryllium peut être utilisé dans tous les cas d'une manière sûre, à condition que la température superficielle de l'outil ne dépasse pas le niveau de température pour chaque gaz. Ne pas utiliser en présence d'Acétylène, car le contact peut créer des étincelles explosives.

Las herramientas fabricadas en aleación Aluminio-Bronce se pueden utilizar en todos los grupos excepto en IIC (hidrogeno, gas de agua, acetileno, bisulfuro de carbono y nitrato de etilo), respetando siempre la temperatura máxima de superficie.

*Tools made of Al-Bronze alloy can be used in a safe way, always respecting the maximum surface temperature allowed, except for the IIC group (Hydrogen, gas of water, acetylene, bisulphide of carbon, Ethyl nitrate).*

L'aluminium-Bronze est sûr pour tous ces produits sauf pour le groupe IIC (gaz d'eau, Hydrogène, Acétylène, Bisulfure de carbone et Nitrato d'éthyle, encore que de tous ces gaz seul l'hydrogène est común), à condition que la température superficielle de l'outil ne dépasse pas le niveau de température pour chaque gaz.

## HERRAMIENTAS DE COBRE O LATÓN COPPER OR BRASS TOOLS OUTILS EN CUIVRE OU EN LAITON

**Las herramientas de cobre o latón son seguras en ambientes explosivos.**

EGA Master tiene disponible una gama completa de martillos y mazas de cobre y latón a disposición de los clientes.

Es conveniente saber que las herramientas de cobre o latón no pueden ser nunca considerados como sustitutos de las herramientas de aluminio-bronce o cobre-berilio, debido a que su dureza es muy inferior a la necesaria para la mayoría de aplicaciones. Existe la tentación de escoger herramientas en cobre o latón debido a su menor coste respecto a las aleaciones de aluminio-bronce o cobre-berilio. Esta opción no solo es peligrosa de por sí, sino que hará que a corto plazo tengamos que reemplazarlas por nuevas unidades debido al desgaste sufrido por sus bajas durezas.

Por tanto, las herramientas de cobre o latón deberían ser empleadas únicamente en aquellas aplicaciones que se deban llevar a cabo en zonas de riesgo de explosión, si la misma aplicación requiriese emplear herramientas de cobre o latón en un ambiente sin riesgo de explosión.

Si usted emplearía una herramienta de acero en una zona sin riesgo de explosión, entonces debe escoger por su seguridad y rentabilidad herramientas fabricadas en aluminio-bronce o cobre-berilio para realizar la misma labor en una zona de riesgo, nunca una herramienta de cobre o latón.

*EGA Master has available a complete range of copper and brass hammers and mallets made in both materials.*

*It is convenient to know that copper or brass tools can never be considered as alternatives to aluminum-bronze or copper-beryllium alloy tools, because their hardness is too low for most applications. There is the temptation to choose copper or brass tools due to their lower cost compared to aluminum-bronze or copper-beryllium ones. This choice is not only risky in itself, but in the short/mid term it will be necessary to replace them for new ones because they wear out fast.*

*For this reason, copper or brass tools should only be used in those jobs that have to be made in risky environments, if the same job would be made with copper or brass tools in a non-risky environment. In case you would use a steel tool in a non-risky environment, than you should choose for your safety and profitability tools made in aluminum-bronze or copper-beryllium to make the same job in a risky environment, never a copper or brass tool.*

**Copper or brass tools are safe in explosive environments.**

EGA Master a toute une gamme complète de marteaux et de masses en cuivre et en laiton au service des clients.

Il est important de savoir que les outils en cuivre ou en laiton ne peuvent jamais être considérés comme substitutifs des outils en aluminium-bronce ou en cuivre-béryllium, ceci du à une dureté bien inférieure à celle nécessaire pour la plus part des applications. La tentation de substituer l'alu-Br et le Cu-Bé par le cuivre ou le laiton existe, dû au coût plus bas. Cette option, non seulement est dangereuse, mais aussi peu rentable, car l'outillage en cuivre ou en laiton sera à remplacer à très court terme, car beaucoup moins résistant.

Mais les outils en cuivre ou en laiton devraient être uniquement utilisés pour des applications en zones de risques d'explosions, si le même usage était requis en atmosphère sans risque d'explosion.

Pour un emploi d'outils en acier en atmosphère sans risque d'explosion, alors pour votre sécurité et une meilleure rentabilité, vous devez prendre des outils fabriqués en Aluminium - Bronze ou en Cuivre - Béryllium pour des applications en zone de risque, jamais un outil en cuivre ou en laiton.

**Les outils en cuivre ou en laiton sont sûrs pour une utilisation dans des environnements explosifs.**

## ALEACIÓN ACETILEX, TRABAJO SEGURO INCLUSO EN AMBIENTES DE ACETILENO ACETILEX ALLOY, SAFE WORK EVEN IN ACETYLENE ENVIRONMENTS ALLIAGE ACETILEX, TRAVAIL SÛR MÊME EN PRÉSENCE D'ACÉTHYLÈNE

Los ambientes de acetileno hacen que no se puedan emplear elementos con composiciones de cobre superiores al 65 %. Ambas aleaciones aluminio-bronce y cobre-berilio tienen porcentajes de cobre superiores al 65 %. La razón no estriba en que una chispa de cobre berilio tenga la suficiente energía como para provocar la ignición del acetileno, sino que el cobre puede reaccionar con el acetileno creando acetiluros altamente explosivos de por sí. Por este motivo, se desaconseja el uso de cualquiera de las aleaciones de cobre berilio o aluminio bronce en ambientes de acetileno.

En EGA Master, siempre buscando soluciones innovadoras que aporten mayor seguridad, hemos desarrollado la aleación ACETILEX, 100 % segura en ambientes de acetileno. Una vez más, pioneros en seguridad.

*Items with copper composition higher than 65% should not be used in acetylene environments. Both aluminum bronze and copper-beryllium alloys do have copper compositions higher than 65%. The reason is not that copper beryllium can create a spark with enough energy to create the ignition of acetylene, but that copper reacts with acetylene creating highly explosive acetylides. For this reason, copper-beryllium or aluminum-bronze alloys should not be used in acetylene environments.*

*EGA Master, always committed to find new innovative solutions that will increase safety, has developed the ACETILEX alloy, 100% safe to be used in acetylene environments. Once again, pioneers in safety.*

Las atmósferas en presencia de acétileno font qu'on ne peut utiliser de compositions en cuivre supérieurs à 65%. Les deux alliages aluminium - bronze et cuivre - béryllium ont un pourcentage de cuivre supérieur à 65%. La raison ne repose pas sur le fait que l'étincelle du cuivre-béryllium ait l'énergie suffisante pour provoquer l'ignition de l'acétileno, mais que le cuivre peut avoir une réaction avec l'acétileno, ce qui peut provoquer des particules acétylure hautement explosives. Pour cette raison, il est déconseillé l'utilisation d'alliages de cuivre béryllium ou d'aluminium bronze en présence d'acétileno.

En permanence à la recherche de solutions novatrices ayant la meilleure sécurité, EGA Master a développé l'alliage ACETILEX, 100% sûre en présence d'acétileno. Une fois de plus, pionniers en sécurité.

### PRINCIPALES CAMPOS DE APLICACIÓN MAIN APPLICATION FIELDS PRINCIPAUX CHAMPS D'APPLICATION

Petroquímicas <i>Petrochemicals</i> Petrochimie	Fábrica cervecera <i>Breweries</i> Brasseries
Refinerías <i>Refineries</i> Raffineries	Industrias de procesamiento de alcohol <i>Alcohol processing industries</i> Fabrication d'alcool
Industria del Petróleo <i>Oil Companies</i> Sociétés pétrolières	Destilerías <i>Distilleries</i> Distilleries
Conductos de tubo de Gas y Petróleo <i>Gas &amp; oil pipe lines</i> Conduits de gaz et de pétrole	Bomberos <i>Fire-fighters</i> Pompiers
Estaciones de servicio y energía <i>Power Stations</i> Stations de service et energie	Minas <i>Mines</i> Mines
Fabricación de pintura <i>Paint Manufacturing</i> Fabrication de peinture	Defensa <i>Defence</i> Defense
Fabricación de plástico <i>Plastic manufacturing</i> Fabrication de plastique	Fuerzas aéreas <i>Air Forces</i> Forces aériennes
Industria Farmacéutica <i>Pharmaceutical Industry</i> Industrie pharmaceutique	Marina <i>Navy</i> Marine
Industria Pirotécnica <i>Fireworks Industry</i> Industrie pyrotechnique	Fabricación de munición y armas <i>Weapon &amp; ammunition fabrication</i> Fabrication de poudres et explosifs
Industria química <i>Chemical Industry</i> Industrie chimique	Industria aeroespacial <i>Aerospace industry</i> Industrie aérospaciale
Industria papelera <i>Paper making Industries</i> Industrie du papier	Industria del automóvil <i>Automobile Industry</i> Industrie automobile
Silos de harina y molinos <i>Flour silos and mills</i> Silos et moulins	Etc.

### INSTRUCCIONES DE USO Y GARANTÍA INSTRUCTIONS FOR USE & WARRANTY INSTRUCTIONS D'UTILISATION ET GARANTIE

- Las herramientas antichispa no pueden alcanzar la dureza de las herramientas convencionales. Por esta razón en su uso se debe tener un especial cuidado, sin sobreesfuerzos ni alta temperatura.  
*Non-Sparking Tools cannot reach the hardness of conventional tools. For this reason the use of Non-Sparking Tools has to be carried out with special care, avoiding overstraining, heating, etc.*  
L'outillage anti-déflagrant ne peut avoir la même dureté que l'outillage traditionnel. Pour cela, il requiert une attention spéciale, en évitant la surcharge, la chaleur...
- Si en toda llave/destornillador es imperativo emplear la medida correspondiente a la tuerca o tornillo, en el caso de las antichispa lo es aún con más razón, ya que si se usara indebidamente una de distinto tamaño al preceptivo, el efecto cizalla que se causaría, propiciaría su deterioro.  
*To avoid damage being caused to both tool and fastener, it is necessary to always ensure that the correctly sized spanner/wrench/screwdriver is selected. Due to the reduced strength and wear resistance of Non-Sparking Alloys selecting the correctly sized tool becomes essential to avoid premature wear and early deterioration of the tool.*  
S'il est impératif dans tous tournevis/clés d'employer la dimension correspondante à l'écrou ou à la vis, il est encore plus vital dans le cas de l'anti-déflagrant, puisque s'il s'utilise de façon incorrecte la dimension obligatoire, l'effet cisaille causé favorisera sa détérioration.
- El uso de herramientas antichispa no debe ser la única medida preventiva en áreas en las que se ha diseñado para ello. Otros objetos, como ropa o material presencial deben también ser adecuadas para aplicaciones Antichispa.  
*The use of Non-Sparking Tools must not be the only preventive measure in areas which the items are designed for. Other items, clothes or present material must also be adequate for non-sparking purposes.*  
L'utilisation d'outillage anti-déflagrant ne doit pas être le Seul moyen de prévention dans les environnements pour lequel il est concu. D'autres objets, comme les vêtements et matériaux présents doivent aussi être adaptés aux applications anti-déflagrantes.

## CERTIFICADO DE CONFORMIDAD

Certificamos que las herramientas fabricadas en Cobre Berilio poseen propiedades anti-chispa, anti-magnéticas y anti-corrosión.

**Dureza**  
283-365 Brinell  
**Resistencia a la Tracción**  
1250 N/mm<sup>2</sup>  
**Temperatura de Fusión**  
857°C -982°C  
**Porcentaje Composición Química**  
**Be:** 1,8%-2%  
**Ni+Co:** 0,2%-1,2%  
**Otros:** <0,5%  
**Cu Resto**

Certificamos que las herramientas fabricadas en aleación Aluminio - Bronce poseen propiedades antichispa.

**Dureza**  
229-291 Brinell  
**Resistencia a la Tracción**  
800 N/mm<sup>2</sup>  
**Porcentaje Composición Química**  
**Al:** 10%-12%  
**Ni:** 4%-6%  
**Fe+Mn:** <5,8%  
**Otros max:** <0,5%  
**Cu Resto**

## CERTIFICATE OF COMPLIANCE

We hereby certify that, the tools made from Beryllium Copper alloy provide non sparking, non magnetic and non corrosive properties.

**Hardness**  
283-365 Brinell  
**Tensile Strength-Break**  
1250 N/mm<sup>2</sup>  
**Melting Range Temperature**  
857°C -982°C  
**Chemical Composition Percentage**  
**Be:** 1,8%-2%  
**Ni+Co:** 0,2%-1,2%  
**Other max:** <0,5%  
**Cu Balance**

We hereby certify that, the tools made from Aluminium Bronze alloy provide non sparking properties

**Hardness**  
229-291 Brinell  
**Tensile Strength-Break**  
800 N/mm<sup>2</sup>  
**Chemical Composition Percentage**  
**Al:** 10%-12%  
**Ni:** 4%-6%  
**Fe+Mn:** <5,8%  
**Other max:** <0,5%  
**Cu Balance**

**Ega Master S.A.**  
Aner Garmendia  
Managing Director

CERTIFICADO DE SEGURIDAD ANTIEXPLOSIÓN  
ANTIEXPLOSION SAFETY CERTIFICATE  
CERTIFICAT DE SÉCURITÉ ANTI-EXPLOSION

EGA Master certifica la seguridad de sus materiales por el prestigioso Instituto Federal Alemán para la Investigación y Examen de Materiales BAM, miembro notificado de la Unión Europea para la certificación según la Directiva 94/9/EG (ATEX).

*EGA Master non-sparking tools are certified by the prestigious German Federal Institute for Materials Research and Testing (BAM), which is a European Union approved laboratory to certify according to 94/9/EG Directive (Atex).*

La certificación des matériaux d'EGA Master est réalisée par le prestigieux Institut Fédéral Allemand d'investigation et d'examen des matériaux BAM, membre notifié par l'Union Européenne pour la certification selon la directive 94/9/EG (ATEX).



**BAM**  
Federal Institute for  
Materials Research  
and Testing  
12200 Berlin, Germany  
Phone: +49 30 8104 0  
Fax: +49 30 81120 29  
Internet: www.bam.de

**Certificate**  
Nº: **BAM/ZBF/008/10**  
2<sup>nd</sup> Revised version

Hereby it is confirmed by the BAM Certification Body, that the  
**Material aluminium-bronze**  
of the manufacturer  
**EGA Master S.A.**  
**Zorrolleta 11, Jundiz Industrial Estate**  
**01015 Vitoria**  
**SPAIN**

meets the requirements of **BAM Standard operating procedure „StAA-NEG-005“: „StAA zur Schlagfunkenprüfung von Werkstoffpaarungen“** dated 2015-01-12 and thus the non-sparking tools made of this material are appropriate for use in potentially explosive atmospheres of zone 0 and/or 20 according to Directive 1999/92/EC of all explosion groups (I, IIA, IIB & IIC) according to IEC 60079-20-1 (2010), if the terms and conditions set out in the annex to this certificate are met.

The certification is based on certification contract Nº **BAM-ZBF-0013-2010-EGA** and comprises according to standard ISO/IEC 17065:2012 a design-type test with the manufacturer's declaration of conformity (BAM Certification system I).  
The products certified by BAM may be labelled with the certification mark "BAM design-type tested" / "BAM Baumustergeprüft".

**The certificate is valid until 1 August 2020.**

BAM test report **II-1397/2010** dated **2010-07-30** as well as procedure no. **BZS-GS/044/15** form the basis of this certificate.

For Bundesanstalt für Materialforschung und -prüfung (BAM)  
Unter den Eichen 87, 12205 Berlin, **2015-08-24**

  
 Dr. R. Schmidt  
BAM Certification Body



  
 Dr. R. Grätz  
BAM Assessor

Distribution list: 1st Certificate holder                      2nd BAM Certification Body

This certificate may only be published in full wording and without any additions. A revocable written consent shall be obtained from BAM beforehand for any amended reproduction or the publication of any excerpts. The German version is legally binding, except an English version is issued exclusively. Place of jurisdiction is Berlin.

Safety in technology and chemistry

CERTIFICATE

CERTIFICADO DE SEGURIDAD ANTIEXPLOSIÓN  
ANTIEXPLOSION SAFETY CERTIFICATE  
CERTIFICAT DE SÉCURITÉ ANTI-EXPLOSION

EGA Master certifica la seguridad de sus materiales por el prestigioso Instituto Federal Alemán para la Investigación y Examen de Materiales BAM, miembro notificado de la Unión Europea para la certificación según la Directiva 94/9/EG (ATEX).

*EGA Master non-sparking tools are certified by the prestigious German Federal Institute for Materials Research and Testing (BAM), which is a European Union approved laboratory to certify according to 94/9/EG Directive (Atex).*

La certificación des matériaux d'EGA Master est réalisée par le prestigieux Institut Fédéral Allemand d'investigation et d'examen des matériaux BAM, membre notifié par l'Union Européenne pour la certification selon la directive 94/9/EG (ATEX).



**Certificate**  
Nº: **BAM/ZBF/007/10**  
2<sup>nd</sup> Revised version

Hereby it is confirmed by the BAM Certification Body, that the  
**Material beryllium-copper**  
of the manufacturer  
**EGA Master S.A.  
Zorrolleta 11, Jundiz Industrial Estate  
01015 Vitoria  
SPAIN**

meets the requirements of BAM Standard operating procedure „StAA-NEG-005“: „StAA zur Schlagfunkenprüfung von Werkstoffpaarungen“ dated 2015-01-12 and thus the non-sparking tools made of this material are appropriate for use in potentially explosive atmospheres of zone 0 and/or 20 according to Directive 1999/92/EC of all explosion groups (I, IIA, IIB & IIC) according to IEC 60079-20-1 (2010), if the terms and conditions set out in the annex to this certificate are met.

The certification is based on certification contract Nº **BAM-ZBF-0013-2010-EGA** and comprises according to standard ISO/IEC 17065:2012 a design-type test with the manufacturer's declaration of conformity (BAM Certification system I).  
The products certified by BAM may be labelled with the certification mark "BAM design-type tested" / "BAM Baumustergeprüft".

**The certificate is valid until 1 August 2020.**

BAM test report **II-1397/2010** dated **2010-07-30** as well as procedure no. **BZS-GS/044/15** form the basis of this certificate.

for Bundesanstalt für Materialforschung und -prüfung (BAM)  
Unter den Eichen 87, 12205 Berlin, 2015-08-24

  
Dr. R. Schmidt  
BAM Certification Body

  
Dr. R. Grätz  
BAM Assessor

Distribution list: 1st Certificate holder      2nd BAM Certification Body

This certificate may only be published in full wording and without any additions. A revocable written consent shall be obtained from BAM beforehand for any amended reproduction of the publication of any excerpts. The German version is legally binding, except an English version is issued exclusively. Place of jurisdiction is Berlin.

 Safety in technology and chemistry

■ ALICATES / PLIERS / PINCES / ZANGEN / PINZE / ALICATES / ПЛОСКОГУБЦЫ

■ UNIVERSALES / COMBINATION / UNIVERSELLES / KOMBIZANGEN / UNIVERSALE / UNIVERSAIS / КОМБИНИРОВАННЫЕ

COD.	MAT.	COD.	MAT.	L (mm)	g
70100		70530		160	250
70101	Cu-Be	70531	Al-Bron	180	320
70102		70532		200	370

**BMAT** | Modelo registrado / Registered model / Modèle enregistré



■ BOCA PLANA / FLAT NOSE / BECS PLATS / FLACHZANGEN / BECCHI PIATTI / PONTAS CHATAS / УТКОНОСЫ

COD.	MAT.	COD.	MAT.	L (mm)	g
70103	Cu-Be	70533	Al-Bron	160	170

**BMAT** | Modelo registrado / Registered model / Modèle enregistré



■ BOCA REDONDA / ROUND NOSE / BECS ROUNDS / RUNDZANGEN / BECCHI TONDI / PONTAS REDONDAS / КРУГЛОГУБЦЫ

COD.	MAT.	COD.	MAT.	L (mm)	g
70104	Cu-Be	70534	Al-Bron	160	160

**BMAT** | Modelo registrado / Registered model / Modèle enregistré



■ TELEFONISTA / LONG NOSE / TELEPHONE / TELEFONZANGEN / TELEFONISTI / TELEFONISTA / С УДЛИННЕННЫМИ НОСАМИ

COD.	MAT.	COD.	MAT.	L (mm)	g
70105		70535		160	250
76130	Cu-Be	76131	Al-Bron	180	270
70106		70536		200	370

**BMAT** | Modelo registrado / Registered model / Modèle enregistré



■ TELEFONISTA BOCA CURVA / BENT NOSE PLIERS / TELEPHONE BECS COUDES / TELEFONZANGEN GEBOGEN / TELEFONISTI BECCHI PIEGATI / TELEFONISTA PONTAS CURVAS / С ИЗОГНУТЫМИ НОСАМИ

COD.	MAT.	COD.	MAT.	L (mm)	g
73148		73149		160	250
73146	Cu-Be	73151	Al-Bron	180	270
73647		73650		200	370

**BMAT** | Modelo registrado / Registered model / Modèle enregistré



■ CORTE DIAGONAL / DIAGONAL CUTTING PLIERS / COUPANTES DIAGONALES

COD.	MAT.	COD.	MAT.	L (mm)	g
70107		70537		160	250
76474	Cu-Be	76475	Al-Bron	200	370

**BMAT** | Modelo registrado / Registered model / Modèle enregistré



■ CORTE DIAGONAL REFORZADO / HEAVY DUTY CUTTING NIPPERS / COUPANTES RENFORCEÉS / VERSTÄRKTER SEITENSCHNEIDER / TAGLIO LATERALE RINFORZATO / CORTE DIAGONAL REFORÇADO / УСИЛЕННЫЕ БОКОРЕЗЫ

COD.	MAT.	COD.	MAT.	L (mm)	g
72094		72095		160	260
70108	Cu-Be	70538	Al-Bron	180	320

**BMAT** | Modelo registrado / Registered model / Modèle enregistré



■ ALICATE GASISTA / GAS PIPE PLIERS / PINCE GAZIER / ROHRZANGE / PINZA PER GASISTA / ALICATE PARA TUBO DE GAZ / КЛЕЩИ ГАЗОВЫЕ

COD.	MAT.	COD.	MAT.	L (mm)	g
70109	Cu-Be	70539	Al-Bron	210	370

**BMAT** | Modelo registrado / Registered model / Modèle enregistré



Cu-Be Cobre berillo / Beryllium copper / Cuivre beryllium / Kupfer beryllium / Koper beryllium / Rame-berillio / Сплав Медь Бериллий  
Al-Bron Aluminio bronce / Aluminium bronze / Alliage aluminium-bronze / Alliage aluminium-bronze / Aluminium brons / Aluminio bronzo / Сплав Алюминий Бронза



**ALICATE TIPO FORD / SLIP JOINT PLIER / PINCE MOTORISTE / MECHANIKERZANGE / PINZE PER GASISTI / ALICATE MOTORISTA / СКОЛЬЗЯЩИЕ КЛЕЩИ**

COD.	MAT.	COD.	MAT.	L (inch)	g
70114	Cu-Be	70544	Al-Bron	8	250

**BMAT** | Modelo registrado / Registered model / Modèle enregistré

**RELACABLES / WIRESTRIPPER / PINCES À DÉNUDER / ABISOLIERZANGEN / PINZE SPELAFILI / DECAPADORES / КЛЕЩИ ДЛЯ ЗАЧИСТКИ КОНТАКТОВ**

COD.	MAT.	COD.	MAT.	L (mm)	g
73903	Cu-Be	73904	Al-Bron	170	220

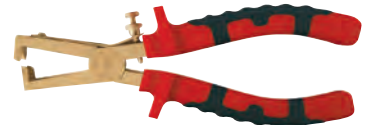
**BMAT** | Modelo registrado / Registered model / Modèle enregistré

**ALICATES CIRCLIPS / CIRCLIPS PLIERS / PINCES POUR CIRCLIPS / ZANGEN FÜR SICHERUNGSRINGE / PINZE PER ANELLI / ALICATES FREIOS / СЪЕМНИК КОЛЕЦ**
**INTERIOR RECTO / INTERNAL STRAIGHT / INTERIEUR DROIT / INNENSICHERUNGSRINGE, GERADE / DIRITTO PER INTERNI / INTERIOR DIREITO / ВНУТРЕННИЕ ПРЯМЫЕ**

COD.	MAT.	COD.	MAT.	O.D. mm	L (mm)	g	
36434	Cu-Be	36435	Al-Bron	3-10	140	110	
76741		76740		8-25			
72511		72510		10-25	200		
72513		72512		19-60			250
72515		72514		40-100			250

**EXTERIOR RECTO / EXTERNAL STRAIGHT / EXTERIEUR DROIT / AUSSENSICHERUNGSRINGE, GERADE / DIRITTA PER ESTERNI / EXTERIOR DIREITO / НАРУЖНЫЕ ПРЯМЫЕ**

COD.	MAT.	COD.	MAT.	O.D. mm	L (mm)	g	
76746	Cu-Be	76745	Al-Bron	3-10	140	120	
36436		36437		8-25			
72517		72516		10-25	200		
72519		72518		19-60			265
72521		72520		40-100			250

**ALICATES MINIS / MINI PLIERS / PINCES MINI / MINI ZANGEN / PINZE MINI / ALICATES MINI / ПЛОСКОГУБЦЫ МИНИ**
**UNIVERSALES / COMBINATION / UNIVERSELLES / KOMBIZANGEN / UNIVERSALI / UNIVERSAIS / КОМБИНИРОВАННЫЕ**

COD.	MAT.	COD.	MAT.	L (mm)	g
79100	Cu-Be	79101	Al-Bron	125	100

**BOCA PLANA / FLAT NOSE / BECS PLATS / FLACHZANGEN / BECCHI PIATTI / PONTAS CHATAS / УТКОНОСЫ**

COD.	MAT.	COD.	MAT.	L (mm)	g
79128	Cu-Be	79129	Al-Bron	125	100

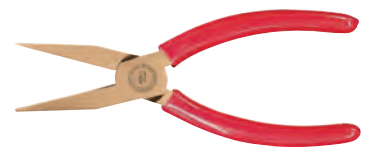

**BOCA REDONDA / ROUND NOSE / BECS RONDOS / RUNDZANGEN / BECCHI TONDI / PONTAS REDONDAS / КРУГЛОГУБЦЫ**

COD.	MAT.	COD.	MAT.	L (mm)	g
79145	Cu-Be	79146	Al-Bron	130	100

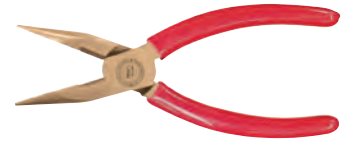

■ TELEFONISTA / LONG NOSE / TÉLÉPHONE / TELEFONZANGEN / TELEFONISTI / TELEFONISTA / СУДЛИНЕННЫМИ НОСАМИ

COD.	MAT.	COD.	MAT.	L (mm)	
79220	Cu-Be	79221	Al-Bron	125	100



■ TELEFONISTA BOCA CURVA / BENT NOSE PLIERS / TÉLÉPHONE BECS COUDÉS / TELEFONZANGEN GEBOGEN / TELEFONISTI BECCHI PIEGATI / TELEFONISTA PONTAS CURVAS / С ИЗОГНУТЫМИ НОСАМИ

COD.	MAT.	COD.	MAT.	L (mm)	
79222	Cu-Be	79223	Al-Bron	125	100



■ BOCA AGUJA / LONG NEEDLE NOSE / LONG BECS DEMI-RONDS / FLACHZANGE MIT LANGEM MAUL / BECCHI TONDI AFFUSOLATI / PONTAS AGULHA / УДЛИНЕННЫЕ ТОНКИЕ

COD.	MAT.	COD.	MAT.	L (mm)	
76128	Cu-Be	76129	Al-Bron	150	100



■ CORTE DIAGONAL / DIAGONAL CUTTING PLIERS / COUPANTES DIAGONALES / SEITENSCHNEIDER / TAGLIO LATERALE / CORTE DIAGONAL / УДЛИНЕННЫЕ ТОНКИЕ

COD.	MAT.	COD.	MAT.	L (mm)	
79228	Cu-Be	79229	Al-Bron	115	100



■ CORTE DIAGONAL TRIANGULAR / DIAGONAL CUTTING TRIANGULAR / COUPANTES DIAGONALE TRIANGULAIRE / SEITENSCHNEIDER / TAGLIO LATERALE TRIANGOLARE / CORTE DIAGONAL TRIANGULAR / БОКОРЕЗЫ ТРЕУГОЛЬНЫЕ

COD.	MAT.	COD.	MAT.	L (mm)	
79230	Cu-Be	79231	Al-Bron	115	100



■ CORTE FRONTAL / END CUTTING NIPPER / COUPANTES DEVANT / VORSCHNEIDER / TAGLIO FRONTALE / CORTE FRONTAL / КЛЕЩИ

COD.	MAT.	COD.	MAT.	L (mm)	
79232	Cu-Be	79233	Al-Bron	110	100



■ TENAZAS / PINCERS / PINCES / ZANGE / TENAGLIE / ALICATES / КЛЕЩИ

■ PICO DE LORO / GROOVE JOINT / MULTIPRISE À CRÉMAILLÈRE / WASSERPUMPENZANGE / PINZE REGOLABILI / BICO DE PAPAGAIO / С ЖЕЛОБКОВЫМ МЕХАНИЗМОМ

COD.	MAT.	COD.	MAT.	L (inch)	
70110	Cu-Be	70540	Al-Bron	10	340
70111		70541		12	700



■ DE CANAL / BOX JOINT / MULTIPRISE ENTREPASSÉE / WASSERPUMPENZANGE / PINZE REGOLABILI / BICO DE PAPAGAIO / ШАРНИРНЫЕ

COD.	MAT.	COD.	MAT.	L (inch)	
73897	Cu-Be	73898	Al-Bron	10	380



COD.	MAT.	COD.	MAT.	L (inch)	
72300	Cu-Be	72302	Al-Bron	10	340



**BMAT**

Cu-Be Cobre berilio / Beryllium copper / Cuivre beryllium / Kupfer beryllium / Koper beryllium / Rame-berillio / Сплав Медь Бериллий  
Al-Bron Aluminio bronze / Aluminium bronze / Alliage aluminium-bronze / Alliage aluminium-bronze / Aluminium brons / Aluminio bronzo / Сплав Алюминий Бронза

05

ANTICHISPA  
NON-SPARKING  
ANTIDÉFLAGRANT  
FUNKENFREI  
ANTISCINTILLA  
ANTI-DEFLAGRANTE  
ИСКРОБЕЗОПАСНЫЙ



**TENAZA GRIP BOCA CURVA / CURVED JAW GRIP PLIER / PINCE ÉTAU BEC COURBÉ / GRIPZANGE / PINZA GRIP A BECCHI PIEGATI / ALICATE DE PRESSÃO DE BOCA CURVA / СТРУБИЦА**

COD.	MAT.	COD.	MAT.	L (inch)	g
79463	Cu-Be	79464	Al-Bron	9	480



**TENAZA DE CARPINTERO / CARPENTER PINCER / PINCE DE MENUISIER / KANTENZANGE / TENAGLIE PER CARPENTIERI / TURQUES DE CARPINTERO / КЛЕЩИ ДЛЯ ПЛИТКИ**

COD.	MAT.	COD.	MAT.	L (inch)	g
70112	Cu-Be	70542	Al-Bron	7	310
70113		70543		8	380



**ALICATE PARA TERMINALES / CRIMPING PLIER / PINCE À SERTIR / CRIMPZANGE / PINZE PER TERMINALI / ALICATE PARA TERMINAIS / ОБЖИМНЫЕ КЛЕЩИ**

COD.	MAT.	COD.	MAT.	L (inch)	g
73900	Cu-Be	73901	Al-Bron	8	220



**LLAVES AJUSTABLES / ADJUSTABLE WRENCHES / CLÉS À MOLETTE / ROLLGABELSCHLÜSSEL / CHIAVI REGOLABILI A RULLINO / CHAVES AJUSTAVÉIS / РАЗВОДНЫЕ КЛЮЧИ**

COD.	MAT.	COD.	MAT.	AF mm	L (mm)	L (inch)	g
71448	Cu-Be	71451	Al-Bron	19	150	6	160
70117		71452		24	200	8	330
70118		71453		28	250	10	550
70119		71454		34	300	12	850
70120		71455		43	375	15	1250
71449		71456		52	450	18	2200
71450		71457		62	600	24	3100
75315		75316		75	900	36	7800



**COMFORT**

COD.	MAT.	COD.	MAT.	AF mm	L (mm)	L (inch)	g
75099	Cu-Be	75098	Al-Bron	19	150	6	180
75112		75111		24	200	8	350
75114		75113		28	250	10	570



**COMFORT**

**LLAVE AJUSTABLE LIGERA / LIGHT ADJUSTABLE WRENCH / CLÉ À MOLETTE LÉGÈRE / VERSTELLBARE ROLLGABEL LEICHT / CHIAVE A RULLINO LEGGERA / CHAVE AJUSTÁVEL LIGEIRA / КЛЮЧ РАЗВОДНОЙ ОБЛЕГЧЕННЫЙ**

COD.	MAT.	COD.	MAT.	AF mm	L (mm)	L (inch)	g
35746	Cu-Be	35747	Al-Bron	20	150	6	140
35748		35749		25	200	8	270
35750		35751		30	250	10	460
35752		35753		35	300	12	710
35754		35755		48	375	15	1500



**Cu-Be** Cobre berilio / Beryllium copper / Cuivre beryllium / Kupfer beryllium / Koper beryllium / Rame-berillio / Сплав Медь Бериллий  
**Al-Bron** Aluminio bronze / Aluminium bronze / Alliage aluminium-bronze / Alliage aluminium-bronze / Aluminium brons / Aluminio bronzo / Сплав Алюминий Бронза

Si no encuentra el artículo que necesita, consúltenos en [info@egamaster.com](mailto:info@egamaster.com) o en [www.egamaster.com](http://www.egamaster.com)  
 If you can't find the item you look for, please ask us in [info@egamaster.com](mailto:info@egamaster.com) or in [www.egamaster.com](http://www.egamaster.com)  
 Si vous ne trouvez pas l'article que vous désirez, consultez-nous a [info@egamaster.com](mailto:info@egamaster.com) ou a [www.egamaster.com](http://www.egamaster.com)

**EGAMaster**  
ART IN INNOVATION

■ EXTRACTORES / GEAR PULLERS / EXTRACTEURS / ABZIEHERS / ESTRATTORI / EXTRACTORES / СЪЕМНИКИ

■ EXTRACTOR 3 GARRAS ARTICULADAS REVERSIBLES / 3 JAW REVERSIBLE GEAR PULLER / EXTRACTEUR 3 BRAS ARTICULES RÉVERSIBLES / AUSSENABZIEHER 3 KLAUEN / ESTRATTORE A 3 BRACCI REVERSIBILI / EXTRACTOR DE 3 GARRAS ARTICULADO REVERSIVEL / СЪЕМНИК С 3-МЯ ЛАПАМИ РЕВЕРСИВНЫЙ

COD.	MAT.	COD.	MAT.	L min.-max.	
72470	Cu-Be	72471	Al-Bron	50-100	4500
72472		72473		60-150	5000
72474		72475		70-200	7000
72476		72477		80-350	13000



■ PINZAS / TWEEZERS / BRUCELLES / GREIFPINZETTEN / PINZETTE DI PRECISIONES / PINÇAS / ПИНЦЕТЫ

■ BOCA FINA / NEAT TIPS / BECS FINS / FEINE BACKEN / A PUNTA FINE / PONTAS FINAS / ПИНЦЕТ ЗАОСТРЕННЫЙ

COD.	MAT.	COD.	MAT.	L (mm)	
70115	Cu-Be	70547	Al-Bron	150	40



■ BOCA PLANA / FLAT NOSE / PLATES / FLACH ZANGE / PUNTA PIATTA / PONTAS PLANAS / УТКОНОСЫ

COD.	MAT.	COD.	MAT.	L (mm)	
70116	Cu-Be	70548	Al-Bron	100	30



■ **LLAVES / WRENCHES / CLÉS / SCHLÜSSEL / CHIAVI / CHAVES / КЛЮЧИ**

■ **LLAVES FIJAS / OPEN-END WRENCHES / CLÉS À FOURCHE / GABELSCHLÜSSEL / CHIAVI FISSE / CHAVES DUAS BOCAS / РОЖКОВЫЕ КЛЮЧИ**

■ **MM**



COD.	MAT.	COD.	MAT.	AF mm	L (mm)	g
75240		75241		4-5	90	30
75242		75243		5-5,5		
70135		70549		6-7		40
70136		70550		6-8	95	50
76871		76872		7-8		55
70137		70551		7-9		60
70138		70552		8-9	100	65
70139		70553		8-10		70
70140		70554		9-10	105	75
70141		70555		9-11	110	85
70142		70556		10-11	115	95
70143		70557		10-12	120	115
76873		76874		10-13		120
70144		70558		10-14	125	125
75244		75245		11-13		135
70145		70559		11-14		145
70146		70560		12-13	130	170
70147		70561		12-14		180
76875		76876		13-14	150	180
73648		73649		13-15	155	200
70148		70562		14-15	165	210
76877		76878		14-16	170	230
70149		70563		14-17	180	270
70150		70564		16-17	185	330
70151	Cu-Be	70565	Al-Bron	16-18	195	360
70152		70566		17-19	200	370
70153		70567		17-22	210	390
70154		70568		18-19	220	410
76879		76880		18-20	230	440
74625		74626		19-20	240	470
70155		70569		19-22	250	500
70156		70570		19-24		
70157		70571		20-22	260	550
74627		74628		21-22	270	
70158		70572		21-23	280	
75246		75247		22-23	290	
70159		70573		22-24	300	
70160		70574		22-27	310	
76090		76091		23-25	320	
76881		76882		23-26	330	
75248		75249		24-25	340	
70161		70575		24-26	350	
70162		70576		24-27	360	
72923		72922		24-30	370	
70163		70577		25-28	380	
76092		76093		26-27	390	
74831		74832		26-29	400	
76094		76095		27-28	410	
70164		70578		27-29	420	
75250		71821		27-30	430	

COD.	MAT.	COD.	MAT.	AF mm	L (mm)	g
75251		75252		28-30	250	650
72925		72924		27-32		700
75253		75254		30-31		750
70165		70579		30-32		
73007		73006		30-34		900
72927		72926		30-36	260	1000
75255		75256		32-34		1100
75257		75258		32-35		1150
70166		70580		32-36		1300
75259		75260		33-35		
70167		70581		34-36	300	1500
75261		75262		35-36		
75263	Cu-Be	75264	Al-Bron	36-38	320	1600
73337		73336		36-41	330	1800
73297		36443		38-40	340	2100
75265		75266		38-42	350	2500
70168		70582		41-46	370	3000
72921		72919		46-50	380	3300
73390		73389		50-52	385	4550
76096		76097		50-55	400	7600
76885		76886		50-60	410	9200
70169		70583		50-62		
70588		70584		55-60		
70589		70585		60-65		
70590		70586		65-70		
70591		70587		70-80		

**Cu-Be** Cobre berillo / Beryllium copper / Cuivre beryllium / Kupfer beryllium / Koper beryllium / Rame-berillio / Сплав Медь Бериллий  
**Al-Bron** Aluminio bronze / Aluminium bronze / Alliage aluminium-bronze / Alliage aluminium-bronze / Aluminium brons / Aluminio bronzo / Сплав Алюминий Бронза

05

**ANTICHISPA  
NON-SPARKING  
ANTIDÉFLAGRANT  
FUNKENFREI  
ANTISCINTILLA  
ANTI-DEFLAGRANTE  
ИСКРОБЕЗОПАСНЫЙ**



## INCH



COD.	MAT.	COD.	MAT.	AF inch	L (mm)	g
70592		70637		7/32-1/4		
70593		70638		1/4-9/32	90	35
70594		70639		1/4-5/16		
70595		70640		5/16-3/8	100	45
70596		70641		3/8-7/16	110	60
75275		75276		3/8-1/2	115	65
70597		70642		7/16-1/2	120	85
70598		70643		1/2-9/16	130	90
70599		70644		1/2-5/8		100
70600		70645		1/2-11/16		110
70601		70646		9/16-5/8	150	120
70602		70647		9/16-3/4		130
70603		70648		19/32-11/16		140
70604		70649		19/32-25/32		150
74835		74836		5/8-11/16	165	
70605		70650		5/8-3/4		160
75277		75278		11/16-3/4		165
70606		70651		11/16-25/32	170	180
70607		70652		11/16-7/8		200
76887		76888		3/4-25/32	180	220
70608		70653		3/4-13/16		
70609		70654		3/4-7/8	185	
70610		70655		25/32-13/16		230
70611		70656		25/32-7/8	190	
70612		70657		13/16-7/8		240
70613		70658		7/8-15/16		300
70614	Cu-Be	70659	Al-Bron	7/8-31/32	210	320
70615		70660		7/8-1	220	340
70616		70661		15/16-1		360
70617		70662		7/8-1.1/16		380
70618		70663		15/16-1.1/16		410
74837		74838		1-1.1/16	230	
70619		70664		1-1.1/8		430
76889		76890		1-1.5/16		450
70620		70665		1.1/16-1.1/8		
70621		70666		1.1/16-1.1/4	250	500
74839		74840		1.1/8-1.3/16		
70622		70667		1.1/8-1.5/16		
75281		75282		1.3/16-1.1/4	260	550
70623		70668		1.1/16-1.7/16		600
70624		70669		1.1/8-1.1/2	270	
75283		75284		1.1/4-1.5/16		700
70625		70670		1.1/4-1.3/8		
70626		70671		1.1/4-1.7/16	290	850
75285		75286		1.5/16-1.3/8		900
70627		70672		1.5/16-1.1/2		
75287		75288		1.3/8-1.7/16	320	1000
70628		70673		1.3/8-1.1/2		1050
70629		70674		1.7/16-1.5/8	330	1250
75289		75290		1.1/2-1.9/16		1300
70630		70675		1.1/2-1.11/16	340	1500
70631		70676		1.5/8-1.13/16		1800
70632		70677		1.3/4-1.5/8	350	2100

COD.	MAT.	COD.	MAT.	AF inch	L (mm)	g
70633		70678		1.11/16-1.7/8	350	2500
70634		70679		1.13/16-2		370
75291		75292		2-2.3/16	380	2800
75293		75294		2-2.3/8		400
70635	Cu-Be	70680	Al-Bron	2.1/16-2.5/16		3100
75295		75296		2.3/16-2.3/8	410	3300
70636		70681		2.1/4-2.3/8		
75297		75298		2.3/8-2.9/16	430	3700

**Cu-Be** Cobre berilio / Beryllium copper / Cuivre beryllium / Kupfer beryllium / Koper beryllium / Rame-berillio / Сплав Медь Бериллий  
**Al-Bron** Aluminium bronze / Aluminium bronze / Alliage aluminium-bronze / Alliage aluminium-bronze / Aluminium brons / Aluminio bronzo / Сплав Алюминий Бронза

05

ANTICHISPA  
NON-SPARKING  
ANTIDÉFLAGRANT  
FUNKENFREI  
ANTISCINTILLA  
ANTI-DEFLAGRANTE  
ИСКРБЕЗОПАСНЫЙ



■ LLAVES COMBINADAS / COMBINATION WRENCHES / CLÉS MIXTES / GABEL RINGSCHLÜSSEL / CHIAVI COMBINATE / CHAVES BOCA E LUNETA / КОМБИНИРОВАННЫЕ КЛЮЧИ

■ MM



COD.	MAT.	COD.	MAT.	AF mm	L (mm)	g
36090		36091		5,5	90	35
70170		70682		6	115	
70171		70683		7	120	40
70172		70684		8	125	45
70173		70685		9	130	60
70174		70686		10	135	65
70175		70687		11	140	70
70176		70688		12	145	85
70177		70689		13	155	95
70178		70690		14	165	100
70179		70691		15	175	110
70180		70692		16	185	150
70181		70693		17	195	160
70182		70694		18	200	190
70183		70695		19	210	210
70184		70696		20	220	240
70185		70697		21	230	260
70186		70698		22	240	280
70187		70699		23	250	350
70188		70700		24	260	380
70189		70701		25		400
70190		70702		26	270	420
70191		70703		27	280	480
70192		70704		28	290	500
70193		70705		29	300	650
70194	Cu-Be	70706	Al-Bron	30	310	700
70195		70707		31	320	750
70196		70708		32	330	800
72700		71786		33		850
72701		71787		34		950
70197		70709		35	340	1100
70198		70710		36		1200
79447		79449		37	350	1400
70199		70711		38		1550
79473		79474		39	360	1750
70200		70712		40	350	2100
70201		70713		41		2200
70202		70714		42	370	2400
79481		79482		43		2600
72654		72649		44	405	3000
76461		76462		45		3550
70203		70715		46	400	4100
70204		70716		50	420	4550
73618		73619		52		
70205		70717		55	430	
73617		73620		58	455	
70206		70718		60	460	
70207		70719		65	470	
70208		70720		70	480	
70209		70721		75	490	
70210		70722		80	500	

COD.	MAT.	COD.	MAT.	AF mm	L (mm)	g
70211	Cu-Be	70723	Al-Bron	85	500	5350
70212		70724		90		5800

Cu-Be Cobre berilio / Beryllium copper / Cuivre beryllium / Kupfer beryllium / Koper beryllium / Rame-berillio / Сплав Медь Бериллий  
Al-Bron Aluminio bronze / Aluminium bronze / Alliage aluminium-bronze / Alliage aluminium-bronze / Aluminium brons / Aluminio bronzo / Сплав Алюминий Бронза

Si no encuentra el artículo que necesita, consúltenos en [info@egamaster.com](mailto:info@egamaster.com) o en [www.egamaster.com](http://www.egamaster.com)  
If you can't find the item you look for, please ask us in [info@egamaster.com](mailto:info@egamaster.com) or in [www.egamaster.com](http://www.egamaster.com)  
Si vous ne trouvez pas l'article que vous désirez, consultez-nous a [info@egamaster.com](mailto:info@egamaster.com) ou a [www.egamaster.com](http://www.egamaster.com)

**EGAMaster**  
ART IN INNOVATION

05

ANTICHISPA  
NON-SPARKING  
ANTIDÉFLAGRANT  
FUNKENFREI  
ANTISCINTILLA  
ANTI-DEFLAGRANTE  
ИСКРОБЕЗОПАСНЫЙ



Management  
System  
ISO 9001:2015  
ISO 14001:2015  
www.tuc.com  
ID 0910098048

to the  
Management  
Quality

■ INCH



COD.	MAT.	COD.	MAT.		L (mm)	
72632		72624		7/32	90	25
70725		70751		1/4	115	
75305		75306		9/32	120	30
70726		70752		5/16	125	
70727		70753		11/32	130	35
70728		70754		3/8		40
76855		76856		13/32		
70729		70755		7/16	135	55
70730		70756		1/2	140	70
70731		70757		9/16		80
75307		75308		19/32	165	95
70732		70758		5/8	175	130
70733		70759		11/16	195	140
70734		70760		3/4	210	
76857		76858		25/32		200
70735		70761		13/16	230	
70736		70762		7/8		280
70737		70763		15/16		330
76859		76860		31/32	260	360
70738		70764		1		
70739		70765		1.1/16	280	460
70740		70766		1.1/8	300	500
72937	Cu-Be	72936	Al-Bron	1.3/16		550
70741		70767		1.1/4	320	700
70742		70768		1.5/16		
70743		70769		1.3/8	350	1000
70744		70770		1.7/16		1150
70745		70771		1.1/2		
75309		75310		1.9/16	360	1200
70746		70772		1.5/8		1350
70747		70773		1.11/16		
75311		75312		1.3/4	370	1500
70748		70774		1.13/16		
70749		70775		1.7/8	400	1600
78975		78976		1.15/16		
70750		70776		2	420	1700
77132		77133		2.1/16		
77156		77157		2.1/8	435	1800
76861		76862		2.3/16		
79028		79029		2.1/4	455	2100
76863		76864		2.3/8	460	2400
76865		76866		2.9/16		
76867		76868		2.5/8	470	2800
76869		76870		2.3/4	480	3300
76463		76464		2.15/16	510	4000
72707		36442		3		4100

**Cu-Be** Cobre berilio / Beryllium copper / Cuivre beryllium / Kupfer beryllium / Koper beryllium / Rame-berillio / Сплав Медь Бериллий  
**Al-Bron** Aluminio bronze / Aluminium bronze / Alliage aluminium-bronze / Alliage aluminium-bronze / Aluminium brons / Aluminio bronzo / Сплав Аллюминий Бронза



05

ANTICHISPA  
NON-SPARKING  
ANTIDÉFLAGRANT  
FUNKENFREI  
ANTISCINTILLA  
ANTI-DEFLAGRANTE  
ИСКРОБЕЗОПАСНЫЙ



LLAVES ACODADAS / DOUBLE OFFSET RING WRENCHES / CLÉS POLYGONALES CONTRE-COUDÉE / RINGSCHLÜSSEL / CHIAVI POLIGONALI / CHAVES LUNETA / ДВОЙНАЯ ИЗОГНУТАЯ ЗВЕЗДОЧКА

MM



COD.	MAT.	COD.	MAT.	AF mm	L (mm)	g	COD.	MAT.	COD.	MAT.	AF mm	L (mm)	g
75320		75321		5,5-7		20	70244		70808		30-36		1050
70213		70777		6-7	120	25	75344		75345		32-34		
75322		75323		6-8		35	72957		72913		32-35	420	1100
70214		70778		7-9			72135		72139		32-36		1150
70215		70779		8-9		50	72136		72140		34-36		
70216		70780		8-10	130	55	70245		70809		36-38		1550
70217		70781		9-10		60	75346		75347		35-41		
70218		70782		9-11		70	75348		75349		38-40	455	1600
70219		70783		10-11		80	70246		70810		36-41		
75324		75325		10-12			75350		75351		38-42		1700
75326		75327		10-13		85	70247	Cu-Be	70811	Al-Bron	41-46	470	2050
70220		70784		10-14	160	100	72251		72250		46-50	490	2200
75318		75319		11-12			73392		73391		50-52		2400
75328		75329		11-13		110	75352		75353		50-55	510	
70221		70785		11-14		120	75354		75355		50-60	535	2450
70222		70786		12-13			72253		72252		55-60		2500
70223		70787		12-14	180	150	75356		75357		60-70	540	3900
70224		70788		13-14			72255		72254		65-70		4000
70225		70789		13-15			76893		76894		70-75	550	4500
70226		70790		14-15		200	72257		72256		75-80	700	5000
72133		72137		14-16									
72134		72138		14-17									
70227		70791		16-17	220	210							
70228		70792		16-18									
70229		70793		17-19		220							
75330	Cu-Be	75331	Al-Bron	17-21		260							
70230		70794		17-22	250	290							
70231		70795		18-19									
75332		75333		19-21		300							
70232		70796		19-22		310							
70233		70797		19-24	280	350							
70234		70798		20-22		370							
70235		70799		21-23		400							
75334		75335		21-26		420							
75336		75337		22-23	310								
70236		70800		22-24		450							
70237		70801		22-27		470							
75338		75339		23-26									
75340		75341		24-25		480							
72822		72823		24-26									
73339		73338		24-27		500							
70238		70802		24-30	340	550							
70239		70803		25-28		600							
74833		74834		26-29									
70240		70804		27-29		650							
70241		70805		27-30		700							
70242		70806		27-32		750							
75342		75343		29-32	360								
70243		70807		30-32		800							
76891		76892		30-34	380	850							
72956		72912		31-33									

**Cu-Be** Cobre berilio / Beryllium copper / Cuivre beryllium / Kupfer beryllium / Koper beryllium / Rame-berillio / Сплав Медь Бериллий  
**Al-Bron** Aluminio bronze / Aluminium bronze / Alliage aluminium-bronze / Alliage aluminium-bronze / Aluminium brons / Aluminio bronzo / Сплав Алюминий Бронза

Si no encuentra el artículo que necesita, consúltenos en [info@egamaster.com](mailto:info@egamaster.com) o en [www.egamaster.com](http://www.egamaster.com)  
 If you can't find the item you look for, please ask us in [info@egamaster.com](mailto:info@egamaster.com) or in [www.egamaster.com](http://www.egamaster.com)  
 Si vous ne trouvez pas l'article que vous désirez, consultez-nous a [info@egamaster.com](mailto:info@egamaster.com) ou a [www.egamaster.com](http://www.egamaster.com)



05

ANTICHISPA  
NON-SPARKING  
ANTIDÉFLAGRANT  
FUNKENFREI  
ANTISCINTILLA  
ANTI-DEFLAGRANTE  
ИСКРОБЕЗОПАСНЫЙ



■ INCH



COD.	MAT.	COD.	MAT.		L (mm)	
70812		70841		7/32-1/4	120	30
74841		74842		1/4-5/16		
70813		70842		5/16-3/8	130	45
70814		70843		3/8-7/16		60
70815		70844		7/16-1/2	160	90
70816		70845		1/2-9/16	180	115
70817		70846		9/16-5/8		190
74843		74844		5/8-11/16		200
70818		70847		5/8-3/4	220	230
75365		75366		11/16-3/4		
70819		70848		11/16-25/32		240
70820		70849		3/4-13/16		290
70821		70850		13/16-7/8	280	350
70822		70851		7/8-15/16		400
70823		70852		7/8-31/32		420
70824		70853		7/8-1	310	440
70825		70854		7/8-1.1/16		480
70826		70855		15/16-1		490
70827		70856		15/16-1.1/16		500
70828		70857		1-1.1/16	340	
70829		70858		1-1.1/8		550
70830		70859		1.1/16-1.1/8		
70831	Cu-Be	70860	Al-Bron	1.1/16-1.1/4	360	600
74845		74846		1.1/8-1.3/16		700
70832		70861		1.1/8-1.5/16		
76895		76896		1.1/8-1.1/2		
75367		75368		1.3/16-1.1/4	380	800
70833		70862		1.1/4-1.5/16		1000
70834		70863		1.1/4-1.7/16		
75369		75370		1.5/16-1.3/8	420	1100
75371		75372		1.3/8-1.7/16		1350
70835		70864		1.7/16-1.5/8		1600
75373		75374		1.1/2-1.9/16	455	1700
70836		70865		1.5/8-1.13/16	470	2050
70837		70866		1.13/16-2	490	2550
75375		75376		2-2.3/16		
70838		70867		2.1/16-2.3/16	510	2800
70839		70868		2-2.3/8		3000
75377		75378		2.3/16-2.3/8	535	3100
70840		70869		2.1/4-2.3/8		3500
75379		75380		2.3/8-2.3/4		3900
76755		76756		2.3/8-2.7/16	540	4000
75381		75382		2.9/16-2.3/4		4200
75383		75384		2.3/4-2.15/16	550	4300

**Cu-Be** Cobre berilio / Beryllium copper / Cuivre beryllium / Kupfer beryllium / Koper beryllium / Rame-berillio / Сплав Медь Бериллий  
**Al-Bron** Aluminio bronze / Aluminium bronze / Alliage aluminium-bronze / Alliage aluminium-bronze / Aluminium brons / Aluminio bronzo / Сплав Аллюминий Бронза

05

**ANTICHISPA  
NON-SPARKING  
ANTIDÉFLAGRANT  
FUNKENFREI  
ANTISCINTILLA  
ANTI-DEFLAGRANTE  
ИСКРОБЕЗОПАСНЫЙ**



■ **KIT DEMO 6 LLAVES / 6 SPANNER DEMO KIT / KIT DÉMO. 6 CLÉS / DEMOKIT 6 SCHLÜSSEL / KIT 6 CHIAVI DI DIMOSTRAZIONE / KIT DEMO 6 CHAVES / ДЕМО НАБОР ИЗ 6 КЛЮЧЕЙ**

COD.		9
<b>69342</b>		300
COD. PCS.		mm
61727	Aerospacial / <i>Aerospatial</i>	
38092	INOX	
73062	1000V	
70172	Cu-Be	8
70684	Al-Bron	
71669	Titanio / <i>Titanium</i>	



■ **SET**

■ **LLAVES FIJAS / OPEN-END WRENCHES / CLÉS À FOURCHE / GABELSCHLÜSSEL / CHIAVI FISSE / CHAVES DUAS BOCAS / РОЖКОВЫЕ КЛЮЧИ**

■ **MM**

COD.	MAT.	PCS.		COD. PCS.	(mm)
<b>76400</b>		6	90052	70135, 70138, 70142, 70146, 70148, 70150	6-7, 8-9, 10-11, 12-13, 14-15, 16-17
<b>76402</b>		8	90053	70135, 70138, 70142, 70146, 70148, 70150, 70154, 70157	6-7, 8-9, 10-11, 12-13, 14-15, 16-17, 18-19, 20-22
<b>76404</b>	Cu-Be	10	90054	70135, 70138, 70142, 70146, 70148, 70150, 70154, 70157, 70158, 70161	6-7, 8-9, 10-11, 12-13, 14-15, 16-17, 18-19, 20-22, 21-23, 24-26
<b>76406</b>		12	90055	70135, 70138, 70142, 70146, 70148, 70150, 70154, 70157, 70158, 70161, 70163, 70165	6-7, 8-9, 10-11, 12-13, 14-15, 16-17, 18-19, 20-22, 21-23, 24-26, 25-28, 30-32
<b>76408</b>		12	90055	70135, 70138, 70142, 70146, 70148, 70150, 70154, 70157, 70158, 70162, 70163, 70165	6-7, 8-9, 10-11, 12-13, 14-15, 16-17, 18-19, 20-22, 21-23, 24-27, 25-28, 30-32



■ **MM**

COD.	MAT.	PCS.		COD. PCS.	(mm)
<b>76401</b>		6	90052	70549, 70552, 70556, 70560, 70562, 70564	6-7, 8-9, 10-11, 12-13, 14-15, 16-17
<b>76403</b>		8	90053	70549, 70552, 70556, 70560, 70562, 70564, 70568, 70571	6-7, 8-9, 10-11, 12-13, 14-15, 16-17, 18-19, 20-22
<b>76405</b>	Al-Bron	10	90054	70549, 70552, 70556, 70560, 70562, 70564, 70568, 70571, 70572, 70575	6-7, 8-9, 10-11, 12-13, 14-15, 16-17, 18-19, 20-22, 21-23, 24-26
<b>76407</b>		12	90055	70549, 70552, 70556, 70560, 70562, 70564, 70568, 70571, 70572, 70575, 70577, 70579	6-7, 8-9, 10-11, 12-13, 14-15, 16-17, 18-19, 20-22, 21-23, 24-26, 25-28, 30-32
<b>76409</b>		12	90055	70549, 70552, 70556, 70560, 70562, 70564, 70568, 70571, 70572, 70576, 70577, 70579	6-7, 8-9, 10-11, 12-13, 14-15, 16-17, 18-19, 20-22, 21-23, 24-27, 25-28, 30-32



**Cu-Be** Cobre berilio / *Beryllium copper* / *Cuivre beryllium* / *Kupfer beryllium* / *Koper beryllium* / *Rame-berillio* / Сплав Медь Бериллий  
**Al-Bron** Aluminio bronce / *Aluminium bronze* / *Alliage aluminium-bronze* / *Alliage aluminium-bronze* / *Aluminium brons* / *Aluminio bronzo* / Сплав Алюминий Бронза

Si no encuentra el artículo que necesita, consúltenos en [info@egamaster.com](mailto:info@egamaster.com) o en [www.egamaster.com](http://www.egamaster.com)  
 If you can't find the item you look for, please ask us in [info@egamaster.com](mailto:info@egamaster.com) or in [www.egamaster.com](http://www.egamaster.com)  
 Si vous ne trouvez pas l'article que vous désirez, consultez-nous a [info@egamaster.com](mailto:info@egamaster.com) ou a [www.egamaster.com](http://www.egamaster.com)

## INCH

COD.	MAT.	PCS.		COD. PCS.	(inch)
76410		6	90052	70596, 70598, 70601, 70603, 74835, 70612	3/8-7/16, 1/2-9/16, 9/16-5/8, 19/32-11/16, 5/8-11/16, 13/16-7/8
76412		8	90053	70596, 70598, 70601, 70603, 74835, 70612, 70609, 70616	3/8-7/16, 1/2-9/16, 9/16-5/8, 19/32-11/16, 5/8-11/16, 3/4-7/8, 13/16-7/8, 15/16-1
76414	Cu-Be	10	90054	70594, 70595, 70596, 70598, 70601, 70612, 70616, 70619, 70621, 74835	1/4-5/16, 5/16-3/8, 3/8-7/16, 1/2-9/16, 9/16-5/8, 5/8-11/16, 13/16-7/8, 15/16-1, 1-1.1/8, 1.1/16-1.1/4
76416		12	90055	70594, 70595, 70596, 70598, 70601, 70609, 70612, 70616, 70619, 70620, 70621, 74835	1/4-5/16, 5/16-3/8, 3/8-7/16, 1/2-9/16, 9/16-5/8, 5/8-11/16, 3/4-7/8, 13/16-7/8, 15/16-1, 1-1.1/8, 1.1/16-1.1/4



## INCH

COD.	MAT.	PCS.		COD. PCS.	(inch)
76411		6	90052	70641, 70643, 70646, 70648, 70657, 74836	3/8-7/16, 1/2-9/16, 9/16-5/8, 19/32-11/16, 5/8-11/16, 13/16-7/8
76413		8	90053	70641, 70643, 70646, 70648, 70654, 70657, 70661, 74836	3/8-7/16, 1/2-9/16, 9/16-5/8, 19/32-11/16, 5/8-11/16, 3/4-7/8, 13/16-7/8, 15/16-1
76415	Al-Bron	10	90054	70639, 70640, 70641, 70643, 70646, 70657, 70661, 70664, 70666, 74836	1/4-5/16, 5/16-3/8, 3/8-7/16, 1/2-9/16, 9/16-5/8, 5/8-11/16, 13/16-7/8, 15/16-1, 1-1.1/8, 1.1/16-1.1/4
76417		12	90055	70639, 70640, 70641, 70643, 70646, 70654, 70657, 70661, 70664, 70665, 70666, 74836	1/4-5/16, 5/16-3/8, 3/8-7/16, 1/2-9/16, 9/16-5/8, 5/8-11/16, 3/4-7/8, 13/16-7/8, 15/16-1, 1-1.1/8, 1.1/16-1.1/4



## LLAVES COMBINADAS / COMBINATION WRENCHES / CLÉS MIXTES / RINGGABELSCHLÜSSEL / CHIAVI COMBinate / CHAVES BOCA E LUNETA / КОМБИНИРОВАННЫЕ КЛЮЧИ

## MM

COD.	MAT.	PCS.		COD. PCS.	(mm)
76418		6	90052	70172, 70174, 70176, 70178, 70181, 70183	8, 10, 12, 14, 17, 19
76420		8	90081	70172, 70174, 70176, 70177, 70178, 70181, 70183, 70186	8, 10, 12, 13, 14, 17, 19, 22
76422		10	90082	70172, 70173, 70174, 70175, 70176, 70177, 70178, 70181, 70183, 70186	8, 9, 10, 11, 12, 13, 14, 17, 19, 22
76424		12	90083	70170, 70171, 70172, 70173, 70174, 70175, 70176, 70177, 70178, 70179, 70180, 70181	6, 7, 8, 9, 10, 11, 12, 13, 14, 15, 16, 17
76426		14	90063	70174, 70175, 70176, 70178, 70180, 70181, 70183, 70184, 70186, 70188, 70189, 70191, 70192, 70196	10, 11, 12, 14, 16, 17, 19, 20, 22, 24, 25, 27, 28, 32
76428	Cu-Be			70170, 70171, 70172, 70173, 70174, 70175, 70176, 70177, 70178, 70179, 70180, 70181, 70182, 70183, 70184, 70185, 70186	6, 7, 8, 9, 10, 11, 12, 13, 14, 15, 16, 17, 18, 19, 20, 21, 22
76430		17	90064	70171, 70172, 70173, 70174, 70175, 70176, 70177, 70178, 70179, 70180, 70181, 70182, 70183, 70184, 70185, 70186, 70188	7, 8, 9, 10, 11, 12, 13, 14, 15, 16, 17, 18, 19, 20, 21, 22, 24
76432		26	90059, 90064	70170, 70171, 70172, 70173, 70174, 70175, 70176, 70177, 70178, 70179, 70180, 70181, 70182, 70183, 70184, 70185, 70186, 70187, 70188, 70189, 70190, 70191, 70192, 70193, 70194, 70196	6, 7, 8, 9, 10, 11, 12, 13, 14, 15, 16, 17, 18, 19, 20, 21, 22, 23, 24, 25, 26, 27, 28, 29, 30, 32



## MM

COD.	MAT.	PCS.		COD. PCS.	(mm)
76419		6	90052	70684, 70686, 70688, 70690, 70693, 70695	8, 10, 12, 14, 17, 19
76421		8	90081	70684, 70686, 70688, 70689, 70690, 70693, 70695, 70698	8, 10, 12, 13, 14, 17, 19, 22
76423		10	90082	70684, 70685, 70686, 70687, 70688, 70689, 70690, 70693, 70695, 70698	8, 9, 10, 11, 12, 13, 14, 17, 19, 22
76425	Al-Bron	12	90083	70682, 70683, 70684, 70685, 70686, 70687, 70688, 70689, 70690, 70691, 70692, 70693	6, 7, 8, 9, 10, 11, 12, 13, 14, 15, 16, 17
76427		14	90063	70686, 70687, 70688, 70690, 70692, 70693, 70695, 70696, 70698, 70700, 70701, 70703, 70704, 70708	10, 11, 12, 14, 16, 17, 19, 20, 22, 24, 25, 27, 28, 32

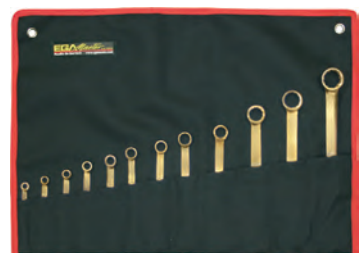

COD.	MAT.	PCS.		COD. PCS.	(mm)
<b>76429</b>	Al-Bron	17	90064	70682, 70683, 70684, 70685, 70686, 70687, 70688, 70689, 70690, 70691, 70692, 70693, 70694, 70695, 70696, 70697, 70698	6, 7, 8, 9, 10, 11, 12, 13, 14, 15, 16, 17, 18, 19, 20, 21, 22
<b>76431</b>				70683, 70684, 70685, 70686, 70687, 70688, 70689, 70690, 70691, 70692, 70693, 70694, 70695, 70696, 70697, 70698, 70700	7, 8, 9, 10, 11, 12, 13, 14, 15, 16, 17, 18, 19, 20, 21, 22, 24
<b>76433</b>		26	90059, 90064	70682, 70683, 70684, 70685, 70686, 70687, 70688, 70689, 70690, 70691, 70692, 70693, 70694, 70695, 70696, 70697, 70698, 70699, 70700, 70701, 70702, 70703, 70704, 70705, 70706, 70708	6, 7, 8, 9, 10, 11, 12, 13, 14, 15, 16, 17, 18, 19, 20, 21, 22, 23, 24, 25, 26, 27, 28, 29, 30, 32

### INCH

COD.	MAT.	PCS.		COD. PCS.	(inch)
<b>76434</b>	Cu-Be	6	90080	70728, 70729, 70730, 70731, 70732, 70734	3/8, 7/16, 1/2, 9/16, 5/8, 3/4
<b>76436</b>		8	90081	70726, 70728, 70729, 70730, 70731, 70732, 70733, 70734	5/16, 3/8, 7/16, 1/2, 9/16, 5/8, 11/16, 3/4
<b>76438</b>		10	90082	70728, 70729, 70730, 70731, 70732, 70733, 70734, 70735, 70736, 70738	3/8, 7/16, 1/2, 9/16, 5/8, 11/16, 3/4, 13/16, 7/8, 1
<b>76440</b>		12	90083	70726, 70728, 70729, 70730, 70731, 70732, 70733, 70734, 70735, 70736, 70737, 70738	5/16, 3/8, 7/16, 1/2, 9/16, 5/8, 11/16, 3/4, 13/16, 7/8, 15/16, 1
<b>76442</b>		14	90063	70728, 70729, 70730, 70731, 70732, 70733, 70734, 70735, 70736, 70737, 70738, 70739, 70740, 70741	3/8, 7/16, 1/2, 9/16, 5/8, 11/16, 3/4, 13/16, 7/8, 15/16, 1, 1.1/16, 1.1/8, 1.1/4



### INCH

COD.	MAT.	PCS.		COD. PCS.	(inch)
<b>76435</b>	Al-Bron	6	90080	70754, 70755, 70756, 70757, 70758, 70760	3/8, 7/16, 1/2, 9/16, 5/8, 3/4
<b>76437</b>		8	90081	70752, 70754, 70755, 70756, 70757, 70758, 70759, 70760	5/16, 3/8, 7/16, 1/2, 9/16, 5/8, 11/16, 3/4
<b>76439</b>		10	90082	70754, 70755, 70756, 70757, 70758, 70759, 70760, 70761, 70762, 70764	3/8, 7/16, 1/2, 9/16, 5/8, 11/16, 3/4, 13/16, 7/8, 1
<b>76441</b>		12	90083	70752, 70754, 70755, 70756, 70757, 70758, 70759, 70760, 70761, 70762, 70763, 70764	5/16, 3/8, 7/16, 1/2, 9/16, 5/8, 11/16, 3/4, 13/16, 7/8, 15/16, 1
<b>76443</b>		14	90063	70754, 70755, 70756, 70757, 70758, 70759, 70760, 70761, 70762, 70763, 70764, 70765, 70766, 70767	3/8, 7/16, 1/2, 9/16, 5/8, 11/16, 3/4, 13/16, 7/8, 15/16, 1, 1.1/16, 1.1/8, 1.1/4



### LLAVES ACODADAS / DOUBLE OFFSET RING WRENCHES / CLÉS POLYGONALES CONTRE-COUDÉE / RINGSCHLÜSSEL / CHIAVI POLIGONALI / CHAVES LUNETAS / КЛЮЧИ ДВОЙНАЯ ИЗОГНУТАЯ ЗВЕЗДОЧКА

### MM

COD.	MAT.	PCS.		COD. PCS.	(mm)
<b>76444</b>	Cu-Be	6	90056	70213, 70215, 70219, 70222, 70226, 70227	6-7, 8-9, 10-11, 12-13, 14-15, 16-17
<b>76446</b>		8	90057	70213, 70215, 70219, 70222, 70226, 70227, 70231, 70234	6-7, 8-9, 10-11, 12-13, 14-15, 16-17, 18-19, 20-22
<b>76448</b>		10	90058	70213, 70215, 70219, 70222, 70226, 70227, 70231, 70234, 70235, 72822	6-7, 8-9, 10-11, 12-13, 14-15, 16-17, 18-19, 20-22, 21-23, 24-26
<b>76450</b>		12	90059	70213, 70215, 70219, 70222, 70226, 70227, 70231, 70234, 70235, 70239, 70243, 72822	6-7, 8-9, 10-11, 12-13, 14-15, 16-17, 18-19, 20-22, 21- 23, 24-26, 25-28, 30-32



## MM

COD.	MAT.	PCS.		COD. PCS.	(mm)
76445		6	90056	70777, 70779, 70783, 70786, 70790, 70791	6-7, 8-9, 10-11, 12-13, 14-15, 16-17
76447		8	90057	70777, 70779, 70783, 70786, 70790, 70791, 70795, 70798	6-7, 8-9, 10-11, 12-13, 14-15, 16-17, 18-19, 20-22
76449	Al-Bron	10	90058	70777, 70779, 70783, 70786, 70790, 70791, 70795, 70798, 70799, 72823	6-7, 8-9, 10-11, 12-13, 14-15, 16-17, 18-19, 20-22, 21-23, 24-26
76451		12	90059	70777, 70779, 70783, 70786, 70790, 70791, 70795, 70798, 70799, 72823, 70803, 70807	6-7, 8-9, 10-11, 12-13, 14-15, 16-17, 18-19, 20-22, 21-23, 24-26, 25-28, 30-32



## INCH

COD.	MAT.	PCS.		COD. PCS.	(inch)
76452		6	90056	70814, 70816, 70817, 70818, 70821, 74843	3/8-7/16, 1/2-9/16, 9/16-5/8, 5/8-3/4, 5/8-11/16, 13/16-7/8
76454		8	90057	70814, 70816, 70817, 70818, 70820, 70821, 70826, 74843	3/8-7/16, 1/2-9/16, 9/16-5/8, 5/8-3/4, 5/8-11/16, 3/4-13/16, 13/16-7/8, 15/16-1
76456	Cu-Be	10	90058	70813, 70814, 70816, 70817, 70821, 70826, 70829, 70831, 74841, 74843	1/4-5/16, 5/16-3/8, 3/8-7/16, 1/2-9/16, 9/16-5/8, 5/8-11/16, 13/16-7/8, 15/16-1, 1-1.1/8, 1.1/16-1.1/4
76458		12	90059	70813, 70814, 70816, 70817, 70820, 70821, 70826, 70829, 70830, 70831, 74841, 74843	1/4-5/16, 5/16-3/8, 3/8-7/16, 1/2-9/16, 9/16-5/8, 5/8-11/16, 3/4-13/16, 13/16-7/8, 15/16-1, 1-1.1/8, 1.1/16-1.1/8, 1.1/16-1.1/4



## INCH

COD.	MAT.	PCS.		COD. PCS.	(inch)
76453		6	90056	70843, 70845, 70846, 70847, 70850, 74844	3/8-7/16, 1/2-9/16, 9/16-5/8, 5/8-3/4, 5/8-11/16, 13/16-7/8
76455		8	90057	70843, 70845, 70846, 70847, 70849, 70850, 70855, 74844	3/8-7/16, 1/2-9/16, 9/16-5/8, 5/8-3/4, 5/8-11/16, 3/4-13/16, 13/16-7/8, 15/16-1
76457	Al-Bron	10	90058	70842, 70843, 70845, 70846, 70847, 70849, 70850, 70855, 70858, 70860, 74842, 74844	1/4-5/16, 5/16-3/8, 3/8-7/16, 1/2-9/16, 9/16-5/8, 5/8-11/16, 13/16-7/8, 15/16-1, 1-1.1/8, 1.1/16-1.1/4
76459		12	90059	70842, 70843, 70845, 70846, 70849, 70850, 70855, 70858, 70859, 70860, 74842, 74844	1/4-5/16, 5/16-3/8, 3/8-7/16, 1/2-9/16, 9/16-5/8, 5/8-11/16, 3/4-13/16, 13/16-7/8, 15/16-1, 1-1.1/8, 1.1/16-1.1/8, 1.1/16-1.1/4



# EGA Master

## ART IN INNOVATION

05

ANTICHISPA  
NON-SPARKING  
ANTIDÉFLAGRANT  
FUNKENFREI  
ANTISCINTILLA  
ANTI-DEFLAGRANTE  
ИСКРОБЕЗОПАСНЫЙ



LLAVE ESTRELLA PLANA / DOUBLE ENDED FLAT RING SPANNER / POLYGONALE PLATE / DOPPELRINGSCHLÜSSEL / POLIGONALE DIRITTA / LUNETTA DIREITA / ДВОЙНАЯ ИЗОГНУТАЯ ПЛОСКАЯ ЗВЕЗДОЧКА

■ MM



COD.	MAT.	COD.	MAT.	AF mm	L (mm)	g
76817		76818		6-7	100	20
73960		73961		7-9	115	40
76819		76820		8-10		
76821		76822		9-11		55
73962		73963		10-11	140	60
75418		75419		10-12		
73964		73965		12-14	160	100
77130		77131		13-15	180	110
73966		73967		14-17		
73968		73969		16-18	200	180
76084		76085		17-19	220	260
73970		73971		18-19		
73972		73973		17-22	230	280
73974	Cu-Be	73975	Al-Bron	19-21	240	300
75420		75421		19-22		
73976		73977		20-22	250	350
73978		73979		21-23	280	390
73980		73981		22-24	300	430
73982		73983		24-27	350	550
73984		73985		25-28	400	600
77134		77135		26-28		
73986		73987		27-30	310	700
73988		73989		27-32	320	
73990		73991		30-32	340	750
77136		77137		30-36	350	800
74771		74772		32-36	360	1000
74773		74774		36-41	460	1400

■ INCH



COD.	MAT.	COD.	MAT.	AF inch	L (mm)	g
76781		76782		7/32-1/4		
76783		76784		1/4-5/16	100	20
76785		76786		5/16-3/8	115	40
76787		76788		3/8-7/16	140	55
76789		76790		7/16-9/16	160	95
77138		77139		1/2-19/32		
76791		76792		1/2-5/8	180	110
76793		76794		9/16-11/16		
76795		76796		5/8-25/32		
76797		76798		11/16-3/4	225	250
77140		77141		11/16-13/16		
76799	Cu-Be	76800	Al-Bron	3/4-7/8	250	350
76801		76802		13/16-15/16	280	430
76803		76804		7/8-15/16		
76805		76806		15/16-1.1/16	300	550
76807		76808		1-1.1/8	310	650
76809		76810		1.1/16-1.3/16		
77142		77143		1.1/8-1.5/16	340	750
76811		76812		1.3/16-1.1/4		
77144		77145		1.1/4-1.3/8		
76813		76814		1.1/4-1.7/16	360	1000
77146		77147		1.5/16-1.7/16		
76815		76816		1.7/16-1.5/8		
77148		77149		1.1/2-1.5/8	380	1350

# BE SAFE...BE EFFICIENT

**Cu-Be** Cobre berilio / Beryllium copper / Cuivre beryllium / Kupfer beryllium / Koper beryllium / Rame-berillio / Сплав Медь Бериллий  
**Al-Bron** Aluminio bronce / Aluminium bronze / Alliage aluminium-bronze / Alliage aluminium-bronze / Aluminium brons / Aluminio bronzo / Сплав Алюминий Бронза

Si no encuentra el artículo que necesita, consúltenos en [info@egamaster.com](mailto:info@egamaster.com) o en [www.egamaster.com](http://www.egamaster.com)  
 If you can't find the item you look for, please ask us in [info@egamaster.com](mailto:info@egamaster.com) or in [www.egamaster.com](http://www.egamaster.com)  
 Si vous ne trouvez pas l'article que vous desirez, consultez-nous a [info@egamaster.com](mailto:info@egamaster.com) ou a [www.egamaster.com](http://www.egamaster.com)

**EGAMaster**  
ART IN INNOVATION

■ LLAVE DE CARRACA / RATCHET SPANNER / CLÉ À CLIQUET / KNARRENSCHLÜSSEL / CHIAVE A CRICCO / CHAVE RAPIDA ABERTA COM ROQUETE / ТРЕЩЕТКА

■ MM

COD.	MAT.	COD.	MAT.	AF mm	L (mm)	g
70870		70887		9		160
70871		70888		11	150	180
70872		70889		13		
70873		70890		14	155	190
70874		70891		17		200
70875		70892		19	200	
70876		70893		22		210
70877		70894		24	220	
70878	Cu-Be	70895	Al-Bron	27	240	220
70879		70896		30		
70880		70897		32	280	230
70881		70898		36	290	
70882		70899		41	295	260
70883		70900		46		450
70884		70901		50	360	550
70885		70902		55		650
70886		70903		60	440	850



■ INCH

COD.	MAT.	COD.	MAT.	AF inch	L (mm)	g
70904		70920		3/8	150	160
70905		70921		1/2		
70906		70922		9/16	155	190
70907		70923		11/16		200
70908		70924		3/4	200	
70909		70925		7/8		210
70910		70926		1	220	
70911	Cu-Be	70927	Al-Bron	1.1/16	240	220
70912		70928		1.3/16		
70913		70929		1.1/4	280	230
70914		70930		1.7/16		
70915		70931		1.5/8	290	260
70916		70932		1.13/16		450
70917		70933		2	360	550
70918		70934		2.3/16		650
70919		70935		2.3/8	440	850





05

ANTICHISPA  
NON-SPARKING  
ANTIDÉFLAGRANT  
FUNKENFREI  
ANTISCINTILLA  
ANTI-DEFLAGRANTE  
ИСКРБЕЗОПАСНЫЙ



LLAVE ESTRELLA ACODADA PARA ESTRUCTURA / OFFSET RING STRUCTURAL WRENCH / CLÉ POLYGALE CONTRE-COUDÉE POUR STRUCTURE MÉTALLIQUE / RINGSCHLÜSSEL  
GEKRÖPFT MIT DORN / CHIAVE POLIGONALE PER PONTEGGI / CHAVE LUNETA INCLINADA PARA ESTRUTURA / КЛЮЧ НАКИДНОЙ ОДНОСТОРОННИЙ ВИЛКООБРАЗНЫЙ  
СТРОИТЕЛЬНЫЙ

■ MM



COD.	MAT.	COD.	MAT.	AF mm	L (mm)	g
75424		75425		10	200	90
75426		75427		11	210	100
75428		75429		12	220	110
75430		75431		13	230	120
75432		75433		14	240	140
75434		75435		15	250	170
75436		75437		16	260	190
75438		75439		17		200
77436		77437		18		230
75440		75441		19	270	330
77438		77439		20		
75442		75443		21		360
70248		71732		22		
76523		76524		23	290	
70249		71733		24		500
77440		77441		25		
77442		77443		26	320	
70250		71734		27		
77444	Cu-Be	77445	Al-Bron	28		700
77446		77447		29	350	
70251		71735		30		
70252		71736		32	370	800
77448		77449		33		
77450		77451		34		
77452		77453		35	390	900
70253		71737		36		
77454		77455		37		
70254		71738		38	400	1000
70255		71739		41	410	
77456		77457		42		
70256		71740		44	420	1100
70257		71741		46		
77458		77459		47		
70258		71742		50	430	1300
75444		75445		55	550	2100
75446		75447		60	600	2500

■ INCH



COD.	MAT.	COD.	MAT.	AF inch	L (mm)	g
77460		77461		11/16	310	190
77462		77463		3/4		
77464		77465		25/32	330	240
77466		77467		13/16		
76839		76840		7/8	350	300
76841		76842		15/16		
77468		77469		31/32	370	380
77470		77471		1		
77472		77473		1.1/16	400	480
77474		77475		1.1/8		650
77476		77477		1.3/16		
74608	Cu-Be	74609	Al-Bron	1.1/4	430	700
77478		77479		1.5/16		
77480		77481		1.3/8	460	900
74612		74613		1.7/16		
74610		74611		1.1/2		1150
77482		77483		1.9/16	490	
74614		74615		1.5/8		1200
77484		77485		1.11/16		
77486		77487		1.3/4	500	1500
74616		74617		1.13/16		
77488		77489		1.7/8	520	
74618		74619		2	550	1900

Cu-Be Cobre berilio / Beryllium copper / Cuivre beryllium / Kupfer beryllium / Koper beryllium / Rame-berillio / Сплав Медь Бериллий  
Al-Bron Aluminio bronze / Aluminium bronze / Alliage aluminium-bronze / Alliage aluminium-bronze / Aluminium brons / Aluminio bronzo / Сплав Аллюминий Бронза

Si no encuentra el artículo que necesita, consúltenos en [info@egamaster.com](mailto:info@egamaster.com) o en [www.egamaster.com](http://www.egamaster.com)  
If you can't find the item you look for, please ask us in [info@egamaster.com](mailto:info@egamaster.com) or in [www.egamaster.com](http://www.egamaster.com)  
Si vous ne trouvez pas l'article que vous desirez, consultez-nous a [info@egamaster.com](mailto:info@egamaster.com) ou a [www.egamaster.com](http://www.egamaster.com)

**LLAVE FIJA ACODADA PARA ESTRUCTURA / OFFSET OPEN END STRUCTURAL WRENCH / CLÉ À FOURCHE CONTRE-COUDÉE POUR STRUCTURE MÉTALLIQUE / MAULSCHLÜSSEL  
GEKRÖPFT MIT DORN / CHIAVE FISSA PER PONTEGGI / CHAVE BOCA INCLINADA PARA ESTRUTURA / КЛЮЧ ГАЕЧНЫЙ ОДНОСТОРОННИЙ ВИЛКОБРАЗНЫЙ СТРОИТЕЛЬНЫЙ**

■ **MM**

COD.	MAT.	COD.	MAT.	AF <sup>mm</sup>	L (mm)	g
75450		75451		17	320	210
77490		77491		18		300
75452		75453		19		
77492		77493		20	350	320
77494		77495		21		410
75454		75455		22		430
77496		77497		23		450
75456		75457		24		
77498		77499		25		480
77500		77501		26	370	600
75458		75459		27		
77502		77503		28		650
77504		77505		29		750
75460	Cu-Be	75461	Al-Bron	30	400	800
73940		73941		32		850
77506		77507		33		
77508		77509		34		
77510		77511		35	430	900
73942		73943		36		
77512		77513		37		1200
77514		77515		38		
73944		73945		41	470	1900
77516		77517		42		
73946		73947		46	500	2800
77518		77519		47		
73948		73949		50	550	3700



■ **INCH**

COD.	MAT.	COD.	MAT.	AF <sup>inch</sup>	L (mm)	g
77520		77521		11/16	320	200
77522		77523		3/4		300
77524		77525		25/32	350	
77526		77527		13/16		410
77528		77529		7/8		450
77530		77531		15/16	370	600
77532		77533		1.1/16		
77534		77535		1.1/8		
77536		77537		1.3/16	400	750
77538		77539		1.1/4		
77540	Cu-Be	77541	Al-Bron	1.5/16	430	900
77542		77543		1.3/8		
77544		77545		1.7/16	470	1200
77546		77547		1.1/2		
77548		77549		1.9/16		
77550		77551		1.5/8	500	1500
77552		77553		1.11/16		
77554		77555		1.3/4		
77556		77557		1.13/16	530	1700
77558		77559		1.7/8		
77560		77561		2		



05

ANTICHISPA  
NON-SPARKING  
ANTIDÉFLAGRANT  
FUNKENFREI  
ANTISCINTILLA  
ANTI-DEFLAGRANTE  
ИСКРБЕЗОПАСНЫЙ



LLAVE PARA RACORES / FLARE NUT / CLÉ POLYGONALE À TUYAUTER / OFFENER DOPPELRINGSCHÜSSEL / CHIAVE PER RACCORDI / LUNETAS ABERTAS COM BATENTE / КЛЮЧ С ОТКРЫТОЙ ЗВЕЗДОЧКОЙ

■ MM

COD.	MAT.	COD.	MAT.	AF mm	L (mm)	g
77570		77571		6 x 7	95	15
77572		77573		8 x 10	115	30
77574		77575		9 x 11	125	35
77576		77577		10 x 12	140	50
77578		77579		12 x 14	145	65
77580		77581		14 x 15	155	85
77582		77583		14 x 17	165	95
77584		77585		16 x 18	170	120
77586		77587		17 x 19	185	125
77588		77589		19 x 22	200	170
77590	Cu-Be	77591	Al-Bron	22 x 24	220	220
77592		77593		24 x 27	255	300
77594		77595		24 x 30	270	
77596		77597		25 x 28	265	360
77598		77599		27 x 30	280	410
77600		77601		30 x 32	295	480
77602		77603		30 x 34	310	550
77604		77605		30 x 36	330	650
77606		77607		34 x 36	345	700
77608		77609		36 x 41	365	900



■ INCH

COD.	MAT.	COD.	MAT.	AF inch	L (mm)	g
72723		72724		3/8-7/16	135	50
72725		72726		7/16-1/2	150	100
72727		72728		1/2-9/16	155	150
72729		72730		9/16-5/8	170	250
72731	Cu-Be	72732	Al-Bron	5/8-3/4	195	300
72733		72734		3/4-7/8	220	350
72735		72736		7/8-1	235	400
72737		72738		1-1.1/8	265	500



**Cu-Be** Cobre berilio / Beryllium copper / Cuivre beryllium / Kupfer beryllium / Koper beryllium / Rame-berillio / Сплав Медь Бериллий  
**Al-Bron** Aluminio bronce / Aluminium bronze / Alliage aluminium-bronze / Alliage aluminium-bronze / Aluminium brons / Aluminio bronzo / Сплав Аллюминий Бронза

Si no encuentra el artículo que necesita, consúltenos en [info@egamaster.com](mailto:info@egamaster.com) o en [www.egamaster.com](http://www.egamaster.com)  
If you can't find the item you look for, please ask us in [info@egamaster.com](mailto:info@egamaster.com) or in [www.egamaster.com](http://www.egamaster.com)  
Si vous ne trouvez pas l'article que vous désirez, consultez-nous a [info@egamaster.com](mailto:info@egamaster.com) ou a [www.egamaster.com](http://www.egamaster.com)

05

**ANTICHISPA  
NON-SPARKING  
ANTIDÉFLAGRANT  
FUNKENFREI  
ANTISCINTILLA  
ANTI-DEFLAGRANTE  
ИСКРОБЕЗОПАСНЫЙ**



Management System  
ISO 9001:2015  
ISO 14001:2015  
www.suc.com  
ID 091058046



■ **FIJA DE GOLPE / SLOGGING OPEN WRENCH / À FOURCHE À FRAPPER / SCHLAG MAULSCHLÜSSEL / FISSE AD IMPULSO / BOCA DE IMPACTO / УДАРНЫЙ РОЖКОВЫЙ КЛЮЧ**

■ **MM**

COD.	MAT.	COD.	MAT.	AF mm	L (mm)	Kg
70280		71013		14		
70281		71014		17	130	0,1
70282		71015		19		
70283		71016		22		
70284		71017		24	150	0,2
74875		74876		25		
70285		71018		27		0,3
74877		74878		28	170	
77278		77279		29		
70286		71019		30		0,4
70287		71020		32	190	
77280		77281		33		0,5
74847		74848		34		0,6
77282		77283		35		
70288		71021		36	210	0,7
77284		77285		37		
74341		74342		38		0,8
70289		71022		41		
77286		77287		42	225	0,9
79089		77778		45		
70290		71023		46	245	1,1
77288		77289		47		
70291		71024		50		1,2
77290		77291		52	270	1,4
77292		77293		54		
70292		71025		55	300	1,5
77294		77295		56		1,8
77296	Cu-Be	77297	Al-Bron	58		
70293		71026		60	310	2
77298		77299		63		2,4
70294		71027		65		
77300		77301		67	340	2,5
70295		71028		70		
77302		77303		71	365	3
70296		71029		75		
77304		77305		77	375	3,5
71007		71030		80		
77306		77307		82	395	4
71008		71031		85	405	
77308		77309		88		5
71009		71032		90	438	
77310		77311		94		6,5
71010		71033		95	445	
71011		71034		100	480	8,5
71012		71035		105	500	
74849		74850		110	510	
74880		74881		115	520	
77312		77313		120	530	12
74761		74762		125	545	
77314		77315		130	560	
77316		77317		135	575	18
77318		77319		140	585	
77320		77321		145	630	
77322		77323		150	640	24
77324		77325		155	650	



**Cu-Be** Cobre berilio / Beryllium copper / Cuivre beryllium / Kupfer beryllium / Koper beryllium / Rame-berillio / Сплав Медь Бериллий  
**Al-Bron** Aluminio bronze / Aluminium bronze / Alliage aluminium-bronze / Alliage aluminium-bronze / Aluminium brons / Aluminio bronzo / Сплав Аллюминий Бронза

## ■ INCH

COD.	MAT.	COD.	MAT.	AF <sup>inch</sup>	L (mm)	Kg
71036		71055		9/16		0,2
72105		72113		5/8	130	
71037		71056		11/16		0,3
71038		71057		3/4		
71039		71058		7/8		
71040		71059		15/16	150	0,4
72106		72114		1		0,6
71041		71060		1.1/16	170	
72107		72115		1.1/8		
74851		74852		1.3/16		
71042		71061		1.1/4	190	0,7
77326		77327		1.5/16		
72108		72116		1.3/8		
71043		71062		1.7/16	210	
72109		72117		1.1/2		
77328		77329		1.9/16		
71044		71063		1.5/8	225	1,6
77330		77331		1.11/16		
77332		77333		1.3/4		
71045		71064		1.13/16	245	
72110		72118		1.7/8		1,8
71046		71065		2	270	
77334		77335		2.1/16		2,1
77336		77337		2.1/8		
71047		71066		2.3/16	300	2,6
72111		72119		2.1/4		3
77338	Cu-Be	77339	Al-Bron	2.5/16		
71048		71067		2.3/8	310	4
77340		77341		2.7/16		
72112		72120		2.1/2		
71049		71068		2.9/16	340	
77342		77343		2.5/8		4,5
74853		74854		2.3/4	365	
77344		77345		2.13/16		
77346		77347		2.15/16		
71050		71069		3	375	7
71051		71070		3.1/8		
74855		74856		3.3/16	395	
77348		77349		3.1/4		8,5
74857		74858		3.3/8	405	
77350		77351		3.1/2		
71052		71071		3.9/16	438	
77352		77353		3.5/8		10
74859		74860		3.3/4	445	
77354		77355		3.7/8		11
71053		71072		4	480	
77356		77357		4.1/8	500	12
71054		71073		4.5/16	510	
77358		77359		4.9/16	520	13
77360		77361		4.11/16	530	
77362		77363		4.15/16	560	16
77364		77365		5.3/8	575	
77366		77367		6	640	23



**ESTRELLA DE GOLPE / SLOGGING RING / POLYGONALE À FRAPPER / SCHLAG RINGSCHLÜSSEL / POLIGONALE AD IMPULSO / LUNETTA DE IMPACTO / УДАРНЫЙ КЛЮЧ ЗВЕЗДОЧКА**
**MM**

COD.	MAT.	COD.	MAT.	AF mm	L (mm)	Kg	COD.	MAT.	COD.	MAT.	AF mm	L (mm)	Kg
70297		71080		17			72615		72625		67	290	
35652		35653		18	150	0,1	72656		72702		68		
70298		71081		19			72657		72703		69		2,5
72231		72230		20			70312		71095		70	320	
77150		77151		21			72616		72626		71		
70299		71082		22	170	0,2	72658		72704		72		
77564		77565		23			72659		72705		73		
70300		71083		24			72660		72706		74		2,7
72631		72677		25			70313		71096		75	325	
71906		72951		26	180	0,3	72662		72708		76		
70301		71084		27			72617		72627		77		
72633		72679		28			72663		72709		78		
72634		72680		29			72664		72710		79		3
70302		71085		30			70314		71097		80	345	
72635		72681		31	190	0,4	72665		72711		81		
70303		71086		32			72666		72712		82		
72609		72619		33			72667		72713		83		
73326		73331		34			72668		72714		84		3,3
72610		72620		35	200	0,5	70315		71098		85	350	
70304		71087		36			72670		72716		86		
72611		72621		37			72671		72717		87		
71834		71835		38			72672	Cu-Be	73342	Al-Bron	88		3,8
72636		72682		39			72673		72719		89	375	
73327		73332		40	225	0,8	70316		71099		90		
70305	Cu-Be	71088	Al-Bron	41			72675		72721		92		
73328		73333		42			72618		72628		94	395	4,5
72638		72684		43			70317		71100		95		
73329		73334		44			72661		72669		97	445	
72640		72686		45	235	0,9	73345		73344		98	405	5,5
70306		71089		46			70318		71101		100		
72229		72228		47			71074		71102		105	410	6,5
73330		73335		48			72645		72646		108		7,5
72642		72688		49	245	1,1	71075		71103		110	440	8,5
70307		71090		50			71076		71104		115		9
72643		72689		51			71077		71105		120	480	10
70308		71091		52			71078		71106		125	490	10,8
72644		72690		53			71079		71107		130	505	11,3
72613		72623		54	265	1,4	72084		72089		135	530	12,3
70309		71092		55			72085		72090		140	550	13,2
73470		73394		56			72086		72091		145		13,6
72647		72693		57			72087		72092		150	565	14,1
73471		73395		58			72088		72093		155		
72648		72694		59	275	1,7	72212		72210		160	595	16
70310		71093		60									
72650		72696		61									
72651		72697		62									
72652		72698		63									
72653		72699		64	290	2							
70311		71094		65									
72655		73340		66									

**Cu-Be** Cobre berilio / Beryllium copper / Cuivre beryllium / Kupfer beryllium / Koper beryllium / Rame-berillio / Сплав Медь Бериллий  
**Al-Bron** Aluminium bronze / Aluminium bronze / Alliage aluminium-bronze / Alliage aluminium-bronze / Aluminium brons / Aluminio bronzo / Сплав Алюминий Бронза

05

**ANTICHISPA  
NON-SPARKING  
ANTIDÉFLAGRANT  
FUNKENFREI  
ANTISCINTILLA  
ANTI-DEFLAGRANTE  
ИСКРОБЕЗОПАСНЫЙ**



## INCH



COD.	MAT.	COD.	MAT.	AF inch	L (mm)	Kg
74763		74764		1/2	125	
72121		72127		5/8		
71108		71133		11/16	145	0,1
71109		71134		3/4		
71110		71135		7/8	170	0,2
75400		72303		15/16		
71111		71136		1	180	0,3
71112		71137		1.1/16		
72122		72128		1.1/8		
71113		71138		1.3/16	190	0,4
71114		71139		1.1/4		
75397		71789		1.5/16		
72123		72129		1.3/8		0,5
71115		71140		1.13/32	200	
72301		71791		1.7/16		
72124		72130		1.1/2		
75398		71793		1.9/16		
71116		71141		1.5/8	225	0,8
75406		71794		1.11/16		
72125		72131		1.3/4		
71117		71142		1.13/16	235	0,9
72126		72132		1.7/8		
75399		71797		1.15/16	245	1,2
71118		71143		2		
75401		71798		2.1/16		
75402	Cu-Be	71799	Al-Bron	2.1/8		
72954		71800		2.3/16	265	1,4
75403		75404		2.13/64		
71119		71144		2.1/4		
71120		71145		2.5/16		1,7
71121		71146		2.3/8	275	
75405		71801		2.7/16		
71122		71147		2.1/2	290	2
71123		71148		2.9/16		
71124		71149		2.5/8		
71125		71150		2.3/4	320	2,5
77258		77259		2.13/16		
71126		71151		2.15/16		
71127		71152		3	325	2,7
71128		71153		3.1/16		3
71129		71154		3.1/8	345	
77260		77261		3.1/4		3,3
71130		71155		3.3/8	350	
76850		76851		3.1/2		3,8
71131		71156		3.9/16	375	
76849		76852		3.5/8		4
71132		71157		3.3/4	395	
74335		75407		3.7/8		
75408		75409		3.15/16	405	5,5
77262		77263		4		
75410		75411		4.1/8	410	6,5

COD.	MAT.	COD.	MAT.	AF inch	L (mm)	Kg
74331		74332		4.1/4	410	8,5
77264		77265		4.5/16		
75412		75413		4.1/2	435	9
77266		77267		4.9/16		
75414		75415		4.5/8		
75416	Cu-Be	75417	Al-Bron	4.11/16	475	10
74333		74334		4.7/8	490	10,8
77268		77269		4.15/16		
77270		77271		5.1/8	505	11,3
77272		77273		5.3/8	530	12,2
77274		77275		5.11/16	565	13,6
77276		77277		6		14,1

**Cu-Be** Cobre berilio / Beryllium copper / Cuivre beryllium / Kupfer beryllium / Koper beryllium / Rame-berillio / Сплав Медь Бериллий  
**Al-Bron** Aluminio bronze / Aluminium bronze / Alliage aluminium-bronze / Alliage aluminium-bronze / Aluminium brons / Aluminio bronzo / Сплав Алюминий Бронза

Si no encuentra el artículo que necesita, consúltenos en [info@egamaster.com](mailto:info@egamaster.com) o en [www.egamaster.com](http://www.egamaster.com)  
 If you can't find the item you look for, please ask us in [info@egamaster.com](mailto:info@egamaster.com) or in [www.egamaster.com](http://www.egamaster.com)  
 Si vous ne trouvez pas l'article que vous désirez, consultez-nous a [info@egamaster.com](mailto:info@egamaster.com) ou a [www.egamaster.com](http://www.egamaster.com)

ESTRELLA DE GOLPE ACODADA / OFFSET SLOGGING RING WRENCH / CLÉ POLYGONALE À FRAPPER CONTRE-COUDÉE / SCHLAG-RINGSCHLÜSSEL, GEKRÖPFT / POLIGONALE AD IMPULSO A GOMITO / CHAVE LUNETA INCLINADA DE PANCADA / УДАРНЫЙ ИЗОГНУТЫЙ РОЖКОВЫЙ КЛЮЧ

MM



COD.	MAT.	COD.	MAT.	AF mm	L (mm)	g
75465		75466		22		500
75467		75468		24	220	
74122		74123		27	240	650
74124		74125		30		
74126		74127		32	270	900
74128		74129		36	280	1000
72992		72993		38	305	1300
74130		74131		41	300	
74132		74133		46	310	1700
74134		74135		50	320	2000
73593	Cu-Be	73594	Al-Bron	55		2200
73595		73596		60	350	2700
73597		73598		65	380	3200
73599		73600		70	400	3800
73601		73602		75	420	4200
73603		73604		80	430	5200
73605		73606		85		6200
73607		73608		90		
73609		73610		95	440	7000
73611		73612		100		
73613		73614		110		7500
73615		73616		120		8000

INCH



COD.	MAT.	COD.	MAT.	AF inch	L (mm)	g
73653		73654		1.1/16		650
76823		76824		1.3/16	240	
73655		73656		1.1/4	270	900
73657		73658		1.7/16		
73659		73660		1.1/2	280	1000
73661		73662		1.5/8	300	1300
73663		73664		1.3/4		
76825		76826		1.13/16	310	1700
73665		73666		1.7/8		
73667	Cu-Be	73668	Al-Bron	2		
76827		76828		2.3/16	320	2000
73669		73670		2.1/4		
73671		73672		2.3/8		
73673		73674		2.1/2	380	2700
76829		76830		2.9/16		
73675		73676		2.5/8	400	3200
73677		73678		2.3/4		
73679		73680		2.7/8	420	4200
73681		73682		3		

ESTRELLA DE GOLPE CURVA / CURVED SLOGGING RING WRENCH / CLÉ POLYGONALE À FRAPPER COURBEE / ZUGSCHLAGRINGSCHLÜSSEL, GEBOGEN / POLIGONALE AD IMPULSO A CURVA / CHAVE LUNETA CURVA DE PANCADA / УДАРНЫЙ ИЗОГНУТЫЙ РОЖКОВЫЙ КЛЮЧ

MM

COD.	MAT.	COD.	MAT.	AF mm	L (mm)	g
74137		74138		24	160	300
74139		74140		27	170	420
74141		74142		30	180	500
74143		74144		32	190	520
74145		74146		36	210	800
74147	Cu-Be	74148	Al-Bron	41	220	1000
74149		74150		46	240	1200
74151		74152		50	250	1500
74153		74154		55	270	1800
74155		74156		60	280	2200
74157		74158		65	300	2400
74159		74160		70	310	2800





05

ANTICHISPA  
NON-SPARKING  
ANTIDÉFLAGRANT  
FUNKENFREI  
ANTISCINTILLA  
ANTI-DEFLAGRANTE  
ИСКРОБЕЗОПАСНЫЙ



ESTRELLA DE UNA BOCA / SINGLE END RING WRENCH / CLÉ POLYGONALE / EINRINGSCHLÜSSEL / POLIGONALE UNA BOCCA / CHAVE LUNETA DE UMA BOCA / КЛЮЧ ОДИНАРНАЯ ЗВЕЗДОЧКА

MM

COD.	MAT.	COD.	MAT.	AF <sup>mm</sup>	L (mm)	g
73993		73994		8	100	25
73995		73996		10	110	35
73997		73998		12	120	50
76021		76022		13		
73999		74000		14	130	75
77152		77153		15	140	85
74001		74002		16	145	120
74003		74004		17	150	130
74005		74006		18	160	135
74007		74008		19	170	170
74009		74010		20	175	180
74011		74012		21	185	185
74013		74014		22	190	195
76718		76719		23		210
74015		74016		24	210	
76720		76721		25	215	250
76722		76723		26		
74017		74018		27	230	
76724		76725		28		340
76726		76727		29		
74019		74020		30	250	450
74021		74022		32		
76728		76729		33	270	500
74023		74024		34	280	
77154		77155		35		650
74025		74026		36	290	
76088		76089		37		750
74027	Cu-Be	74028	Al-Bron	38	300	850
74029		74030		41	310	
77158		77159		42		950
74031		74032		45	320	
74033		74034		46	330	
77160		77161		47		1250
74035		74036		48	340	
74037		74038		50	350	
77162		77163		52		1500
77164		77165		54		
74039		74040		55	370	1700
74041		74042		56		
77166		77167		58		1750
74043		74044		60	390	
77168		77169		63		1900
74045		74046		65	410	
77170		77171		67		2200
74047		74048		70	430	
77172		77173		71		2600
74049		74050		75	450	
77174		77175		77		3200
74051		74052		80	470	
77176		77177		82		4000
74053		74054		85	490	
77178		77179		88	600	4450
77180		77181		90		
77182		77183		94	650	5500
77184		77185		95		



**Cu-Be** Cobre berilio / Beryllium copper / Cuivre beryllium / Kupfer beryllium / Koper beryllium / Rame-berillio / Сплав Медь Бериллий  
**Al-Bron** Aluminio bronze / Aluminium bronze / Alliage aluminium-bronze / Alliage aluminium-bronze / Aluminium brons / Aluminio bronzo / Сплав Алюминий Бронза

Si no encuentra el artículo que necesita, consúltenos en [info@egamaster.com](mailto:info@egamaster.com) o en [www.egamaster.com](http://www.egamaster.com)  
If you can't find the item you look for, please ask us in [info@egamaster.com](mailto:info@egamaster.com) or in [www.egamaster.com](http://www.egamaster.com)  
Si vous ne trouvez pas l'article que vous désirez, consultez-nous a [info@egamaster.com](mailto:info@egamaster.com) ou a [www.egamaster.com](http://www.egamaster.com)

**EGA Master**  
ART IN INNOVATION

## INCH

COD.	MAT.	COD.	MAT.	AF <sup>inch</sup>	L (mm)	g
77186		77187		1/2		75
77188		77189		9/16	130	
77190		77191		19/32	140	85
77192		77193		5/8	145	
77194		77195		11/16	155	115
77196		77197		3/4		
77198		77199		25/32	170	125
77200		77201		13/16		
77202		77203		7/8	190	170
77204		77205		15/16		
77206		77207		31/32	215	210
77208		77209		1		
77210		77211		1.1/16	230	260
77212		77213		1.1/8		
77214		77215		1.3/16	255	350
74641		75471		1.1/4	260	
77216		77217		1.5/16	265	450
77218		77219		1.3/8	295	500
74643		75472		1.7/16	300	600
74642		75473		1.1/2		
77220		77221		1.9/16		
74644	Cu-Be	75474	Al-Bron	1.5/8	330	850
77222		77223		1.11/16		
77224		77225		1.3/4		1050
74645		75475		1.13/16	360	
77226		77227		1.7/8		1100
74646		75476		2	400	1400
74647		74648		2.1/16		
77228		77229		2.1/8		
77230		77231		2.3/16	450	1500
77232		77233		2.1/4		
77234		77235		2.5/16		
77236		77237		2.3/8	475	1750
77238		77239		2.7/16		
77240		77241		2.1/2		
77242		77243		2.9/16	510	1950
77244		77245		2.3/4	550	2400
77246		77247		2.15/16		
77248		77249		3	590	2800
77250		77251		3.1/8		
77252		77253		3.3/8	620	3900
77254		77255		3.1/2		
77256		77257		3.3/4	650	5500



**ESTRELLA DE UNA BOCA ACODADA / OFFSET SINGLE END RING WRENCH / CLÉ POLYAGONALE CONTRE COUDÉE / EINRINGSCHLÜSSEL, GEKRÖPFT / CHIAVE A GOMITO A STELLA UNA BOCCA / CHAVE LUNETA BOCA INCLINADA / КЛЮЧ ИЗОГНУТАЯ ОДИНАРНАЯ ЗВЕЗДОЧКА**

■ MM

COD.	MAT.	COD.	MAT.	AF mm	L (mm)	g
74103		74104		17	150	130
74105		74106		19	170	170
74107		74108		21	185	210
74109		74110		22	190	220
74111	Cu-Be	74112	Al-Bron	24	210	280
74113		74114		27	230	350
74115		74116		30	250	480
74117		74118		32	270	600
74119		74120		36	290	750



**ESTRELLA DE UNA BOCA CURVA / CURVED SINGLE END RING WRENCH / CLÉ POLYAGONALE COURBÉE / EINRINGSCHLÜSSEL, GEBOGEN / POLIGONALE UNA BOCCA CURVA / CHAVE LUNETA UMA BOCA CURVA / КЛЮЧ ИЗОГНУТАЯ ОДИНАРНАЯ ЗВЕЗДОЧКА**

■ MM

COD.	MAT.	COD.	MAT.	AF mm	L (mm)	g
74056		74057		10	120	65
74058		74059		12	160	90
74060		74061		14	150	95
74062		74063		16		
74064		74065		17	175	150
74066		74067		19		220
74068		74069		22	200	
74070		74071		24		320
74072		74073		27		
74074		74075		30	250	550
74076		74077		32		
74078	Cu-Be	74079	Al-Bron	34	290	600
74080		74081		36		
74082		74083		38	300	800
74084		74085		41		
74086		74087		46		1000
74088		74089		50	340	
74378		74379		51		1250
74090		74091		55	370	2000
74092		74093		60	400	2400
74094		74095		65	430	2500
74096		74097		70	450	3500
74098		74099		75	470	3900
74100		74101		80	490	4200



■ DE VÁLVULA CUADRADA / VALVE SQUARE / CLÉ À VANNE CARRÉE / VENTILSCHLÜSSEL / VALVOLA QUADRATA / CHAVE DE VÁLVULA QUADRADA / КЛЮЧ С КВАДРАТОМ

■ MM

COD.	MAT.	COD.	MAT.	AF mm	L (mm)	g
74162		74163		6	110	60
74164		74165		8	120	75
74166		74167		9	140	90
74168		74169		10	160	100
74170		74171		11	190	120
74172		74173		12	200	170
74174	Cu-Be	74175	Al-Bron	13	250	180
74176		74177		14	300	270
74178		74179		16	350	300
74180		74181		17	400	380
74182		74183		19	400	700
74184		74185		22	500	950
74186		74187		24	500	1200



■ DE VASO CUADRADA / SQUARE SOCKET / CLÉ À DOUILLE CARRÉE / QUADRATISCHE EINSATZ / BUSSOLA QUADRATA / CHAVE DE CAIXA QUADRADA / ГОЛОВКА С ВНУТРЕННИМ КВАДРАТОМ

■ INCH

COD.	MAT.	COD.	MAT.	AF inch	L (mm)	g
74189	Cu-Be	74190	Al-Bron	3/8	155	180



■ CABEZA FIJA / CROW FOOT OPEN END / FOURCHE / HEBESTANGE / TESTA FISSA / CABEÇA FIXA / РОКОВАЯ НАСАДКА ПОД КВАДРАТ

■ MM

■ INCH



COD.	MAT.	COD.	MAT.	AF mm	L (mm)	AF inch	g
72565		72566		14	40		55
72567		72568		16	45		60
72569		72570		17	50		100
72571		72572		19	50	1/2	105
72573	Cu-Be	72574	Al-Bron	20	55		125
72575		72576		22	60		130
72577		72578		25	60		135
72579		72580		27			
72581		72582		28			

COD.	MAT.	COD.	MAT.	AF inch	L (mm)	AF inch	g
35728		35729		3/8			
74814		74815		7/16	35		
74816		74817		1/2			50
72541		72542		9/16			
72543		72544		5/8	37		
72545		72546		11/16	38		
72547		72548		7/8	43		55
72549	Cu-Be	72550	Al-Bron	1.1/8	50	3/8	75
72551		72552		1.1/4	55		90
72553		72554		1.3/8	60		125
72555		72556		1.1/2	65		160
72557		72558		1.11/16	70		170
72559		72560		1.7/8	75		175
72561		72562		2	80		190
72563		72564		2.1/4			

05

ANTICHISPA  
NON-SPARKING  
ANTIDÉFLAGRANT  
FUNKENFREI  
ANTISCINTILLA  
ANTI-DEFLAGRANTE  
ИСКРОБЕЗОПАСНЫЙ



LLAVE ESTRELLA DE EXTENSIÓN / RING SPANNER FOR EXTENSION / CLÉ POLYGONALE À RALLONGE / RINGSCHLÜSSEL MIT VERLÄNGERUNG / CHIAVE POLIGONALE PER ESTENSORI / CHAVE DE LUNETA DE EXTENSÃO / ИЗОГНУТАЯ ЗВЕЗДОЧКА ПОД УДЛИНИТЕЛЬ

■ MM

■ INCH



COD.	MAT.	COD.	MAT.	AF mm	L (mm)	g
73688		73689		24		
73472		73396		27	200	
70957		70982		30		
70958		70983		32	220	
77368		77369		33		900
70959		70984		34		
70960		70985		35	230	
70961		70986		36		
70962		70987		37		
70963		70988		38		
70964		70989		41	250	1200
70965		70990		42		
70966		70991		46	270	1600
70967		70992		47		
70968		70993		50	280	1700
70969	Cu-Be	70994	Al-Bron	52		
70970		70995		54		
70971		70996		55	290	1800
70972		70997		56		
70973		70998		58		2000
70974		70999		60	310	
70975		71000		63		
70976		71001		65	320	2200
70977		71002		67		
70978		71003		70	330	2700
70979		71004		71		
70980		71005		75	340	3300
70981		71006		77		
77370		77371		80		
77372		77373		82	380	4900
77374		77375		85		

COD.	MAT.	COD.	MAT.	AF inch	L (mm)	g
77376		77377		1.3/16	200	
77378		77379		1.1/4	230	900
77380		77381		1.5/16		
77382		77383		1.3/8	240	
77384		77385		1.7/16		
77386		77387		1.1/2		
77388		77389		1.9/16	260	1000
77390		77391		1.5/8		
77392		77393		1.11/16		
77394		77395		1.3/4		
77396		77397		1.13/16	280	1500
77398		77399		1.7/8		
77400		77401		2	290	1600
77402		77403		2.1/16		
77404	Cu-Be	77405	Al-Bron	2.1/8	300	1700
77406		77407		2.3/16		1800
77408		77409		2.1/4		
77410		77411		2.5/16		
77412		77413		2.3/8	345	2800
77414		77415		2.7/16		
77416		77417		2.1/2		
77418		77419		2.9/16	355	3200
77420		77421		2.5/8		
77422		77423		2.3/4	365	3700
77424		77425		2.13/16		
77426		77427		2.15/16	375	4100
77428		77429		3		
77430		77431		3.1/8		
77432		77433		3.1/4	385	4900
77434		77435		3.3/8		

**Cu-Be** Cobre berilio / Beryllium copper / Cuivre beryllium / Kupfer beryllium / Koper beryllium / Rame-berillio / Сплав Медь Бериллий  
**Al-Bron** Aluminio bronze / Aluminium bronze / Alliage aluminium-bronze / Alliage aluminium-bronze / Aluminium brons / Aluminio bronzo / Сплав Аллюминий Бронза

Si no encuentra el artículo que necesita, consúltenos en [info@egamaster.com](mailto:info@egamaster.com) o en [www.egamaster.com](http://www.egamaster.com)  
 If you can't find the item you look for, please ask us in [info@egamaster.com](mailto:info@egamaster.com) or in [www.egamaster.com](http://www.egamaster.com)  
 Si vous ne trouvez pas l'article que vous desirez, consultez-nous a [info@egamaster.com](mailto:info@egamaster.com) ou a [www.egamaster.com](http://www.egamaster.com)

LLAVE FIJA DE EXTENSION / OPEN-END WRENCH FOR EXTENSION / CLÉ À FOURCHE À RALLONGE / ZUGMAULSCHLÜSSEL / CHIAVE FISSA A ESTENSIONE / CHAVE DE BOCA COM EXTENSÃO / ГАЕЧНЫЙ КЛЮЧ С РУКОЯТКОЙ ПОД УДЛИНИТЕЛЬ

■ MM

COD.	MAT.	COD.	MAT.	AF mm	L (mm)	g
36350		36368		22	200	410
36351		36369		24	230	460
36352		36370		27	260	540
36353		36371		30	280	660
36354	Cu-Be	36372	Al-Bron	32	300	810
36355		36373		36	330	950
36356		36374		41	350	1120
36357		36375		46	380	1550
36358		36376		50	400	1810



■ INCH

COD.	MAT.	COD.	MAT.	AF inch	L (mm)	g
36359		36377		7/8"	200	410
36360		36378		15/16"	230	460
36361		36379		1.1/16"	260	540
36362		36380		1.3/16"	280	660
36363	Cu-Be	36381	Al-Bron	1.1/4"	300	810
36364		36382		1.7/16"	330	950
36365		36383		1.5/8"	350	1120
36366		36384		1.13/16"	380	1550
36367		36385		2"	400	1810



EXTENSIÓN PARA LLAVE ESTRELLA ACODADA Y LLAVE FIJA / EXTENSION FOR OFFSET RING SPANNER AND OPEN-END WRENCHES / RALLONGE POUR CLÉS POLYGONALE CONTRE-COUDÉE À FOURCHE / VERLÄNGERUNG FÜR RINGSCHLÜSSEL / ESTENSIONE PER CHIAVE POLIGONALE ANGOLATA E CHIAVE FISSA / EXTENSÃO PARA CHAVE LUNETEA E CHAVE DE BOCA / УДЛИНИТЕЛЬ ДЛЯ КЛЮЧА ИЗОГНУТАЯ ЗВЕЗДОЧКА

COD.	MAT.	AF mm	AF inch	L (mm)	O.D. mm	g
72612		22-30	1.3/16	460	19	800
72605	Latón / Brass /	32-42	1.1/4-1.11/16	610	22	900
72606	Laiton	46-58	1.3/4-2.5/16	760	25	1600
72607		60-85	2.3/8-3.3/8	860	30	2500



05

**ANTICHISPA  
NON-SPARKING  
ANTIDÉFLAGRANT  
FUNKENFREI  
ANTISCINTILLA  
ANTI-DEFLAGRANTE  
ИСКРОБЕЗОПАСНЫЙ**



■ **FIJA DE UNA BOCA / SINGLE ENDED OPEN JAW SPANNER / À FOURCHE / EINMAULSCHLÜSSEL / FISSE SEMPLICE / FIXA DE UMA BOCA / РОЖКОВЫЙ КЛЮЧ**

■ **MM**



COD.	MAT.	COD.	MAT.	AP mm	L (mm)	g
75385		75386		5	75	30
70259		70936		6	85	
70260		70937		7	90	40
70261		70938		8	90	
70262		70939		9	100	
70263		70940		10	105	
70264		70941		11	110	
72939		71807		12	120	
72940		71808		13	125	
70265		70942		14	130	50
72941		71809		15	135	
72942		71810		16	145	
70266		70943		17	150	
72943		71811		18	155	
70267		70944		19	165	
72944		71812		20	170	70
72945		71813		21	180	85
70268		70945		22	190	100
72946		71814		23	195	150
70269		70946		24	210	
72947		71815		25	220	200
72948		71816		26	230	
70270		70947		27	240	
72949		71817		28	250	250
72950		71818		29	260	270
70271	Cu-Be	70948	Al-Bron	30	270	
72955		72911		31	290	300
70272		70949		32	300	
75387		75388		34	310	400
70273		70950		36	320	
74403		74404		37	320	490
75389		75390		38	340	
74344		74345		39	350	
73300		73305		40	370	500
70274		70951		41	380	
74346		73306		42	400	550
73302		73307		44	420	850
75391		75392		45	450	900
70275		70952		46	450	1000
73303		73308		48	450	
70276		70953		50	450	1200
73304		73309		52	450	
77000		77001		54	450	1400
70277		70954		55	450	
77002		77003		56	450	1800
77004		77005		58	450	
70278		70955		60	450	
77006		77007		63	450	2100
70279		70956		65	450	
77008		77009		67	450	3000
75393		75394		70	550	3200

COD.	MAT.	COD.	MAT.	AP mm	L (mm)	g
77010		77011		71	550	3400
75395		75396		75	550	3500
77012		77013		77	550	4000
77014		77015		80	550	
77016		77017		82	550	5000
77018	Cu-Be	77019	Al-Bron	85	600	5500
77020		77021		88	600	
77022		77023		90	600	5800
77024		77025		94	600	
77026		77027		95	600	5900
77028		77029		100	600	6000

**Cu-Be** Cobre berilio / Beryllium copper / Cuivre beryllium / Kupfer beryllium / Koper beryllium / Rame-berillio / Сплав Медь Бериллий  
**Al-Bron** Aluminio bronze / Aluminium bronze / Alliage aluminium-bronze / Alliage aluminium-bronze / Aluminium brons / Aluminio bronzo / Сплав Алюминий Бронза

Si no encuentra el artículo que necesita, consúltenos en [info@egamaster.com](mailto:info@egamaster.com) o en [www.egamaster.com](http://www.egamaster.com)  
 If you can't find the item you look for, please ask us in [info@egamaster.com](mailto:info@egamaster.com) or in [www.egamaster.com](http://www.egamaster.com)  
 Si vous ne trouvez pas l'article que vous desirez, consultez-nous a [info@egamaster.com](mailto:info@egamaster.com) ou a [www.egamaster.com](http://www.egamaster.com)

## INCH

COD.	MAT.	COD.	MAT.	AF <sup>inch</sup>	L (mm)	g
77030		77031		5/16	90	20
77032		77033		3/8		
77034		77035		13/32	100	35
77036		77037		7/16	105	
77038		77039		1/2		
77040		77041		9/16	125	55
77042		77043		19/32		
77044		77045		5/8	140	95
77046		77047		11/16		
77048		77049		3/4	155	110
77050		77051		25/32		
77052		77053		13/16	170	185
77054		77055		7/8	180	200
77056		77057		15/16		
77058		77059		31/32	195	220
77060		77061		1		
77062		77063		1.1/16	225	310
77064		77065		1.1/8		
77066		77067		1.3/16	255	420
77068		77069		1.1/4		
77070		77071		1.5/16	275	560
77072		77073		1.3/8		
77074		77075		1.7/16	300	850
77076		77077		1.1/2		
77078		77079		1.9/16	325	1000
77080	Cu-Be	77081	Al-Bron	1.5/8		
77082		77083		1.11/16		
77084		77085		1.3/4	350	1100
77086		77087		1.13/16		1200
77088		77089		1.7/8		
77090		77091		2	375	1450
77092		77093		2.1/16		
77094		77095		2.1/8	400	1800
76751		76752		2.3/16		
77096		77097		2.1/4		
77098		77099		2.5/16		
77100		77101		2.3/8	425	2300
77102		77103		2.7/16		
77104		77105		2.1/2		
77106		77107		2.9/16	450	3050
77108		77109		2.5/8		
76753		76754		2.3/4	475	3400
77110		77111		2.13/16		
77112		77113		2.15/16	500	4150
77114		77115		3		
77116		77117		3.1/8		
77118		77119		3.1/4	525	5100
77120		77121		3.3/8	545	5600
77122		77123		3.1/2		
77124		77125		3.5/8	555	5850
77126		77127		3.3/4	560	6000
77128		77129		3.7/8	565	6100





**FIJA DE UNA BOCA CURVA / BENT SINGLE OPEN END / CLE À FOURCHE COUDÉE / GEBOGEN MAUL / FISSA AD UNA BOCCA CURVA / FIXA DE UMA BOCA CURVA / ИЗОГНУТЫЙ РОЖКОВЫЙ**

■ MM

COD.	MAT.	COD.	MAT.	AF mm	L (mm)	g
73909		73910		12	120	50
73911		73912		14	130	80
73913		73914		17	150	120
73915		73916		19		
75479		75480		21	170	170
73917		73918		22	190	240
73919		73920		24	210	250
75481		75482		26		350
73921		73922		27	230	
75483	Cu-Be	75484	Al-Bron	28		370
75485		75486		29		
73923		73924		30	250	470
73925		73926		32	270	550
73927		73928		34	280	700
73929		73930		36	290	800
73931		73932		41	310	1000
73933		73934		46	330	1300
73935		73936		50	350	1500
73937		73938		55	370	2000



**DE PIPA / ANGLED SOCKET / CLÉS À PIPE / PFEIFENSCHLÜSSEL / CHIAVI A PIPA / DE CACHIMBO / ГОЛОВКА С ИЗОГНУТОЙ РУКОЯТКОЙ**

■ MM

COD.	MAT.	COD.	MAT.	AF mm	L (mm)	H (mm)	g
75489		75490		6	120	29	100
75491		75492		7	130	30	120
70417		71361		8	145	33	140
70418		71362		9	155		180
73312		73319		10	170	37	190
70419		71363		11	190	39	210
73313		73320		12	210	42	
73314		73321		13			240
70420		71364		14	240	45	290
73315		73322		15			330
73316		73323		16	250	48	450
70421		71365		17		50	
75493		75494		18	260		500
70422		71366		19			
75495	Cu-Be	75496	Al-Bron	20	270	55	550
75497		75498		21			700
70423		71367		22			
75499		75500		23	280	60	750
70424		71368		24			
75501		75502		25		65	800
75503		75504		26	290		
70425		71369		27		70	850
75505		75506		28			
75507		75508		29			
73317		73324		30	300	75	950
73318		73325		32	310	80	
75509		75510		33			1100
75511		75512		34			
75513		75514		35		85	
72916		72914		36	330		1200

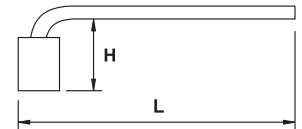

**Cu-Be** Cobre berilio / Beryllium copper / Cuivre beryllium / Kupfer beryllium / Koper beryllium / Rame-berillio / Сплав Медь Бериллий  
**Al-Bron** Aluminio bronze / Aluminium bronze / Alliage aluminium-bronze / Alliage aluminium-bronze / Aluminium brons / Aluminio bronzo / Сплав Алюминий Бронза

05

**ANTICHISPA  
NON-SPARKING  
ANTIDÉFLAGRANT  
FUNKENFREI  
ANTISCINTILLA  
ANTI-DEFLAGRANTE  
ИСКРОБЕЗОПАСНЫЙ**



COD.	MAT.	COD.	MAT.	AF mm	L (mm)	H (mm)	g
75515		75516		37	330	85	1200
75517		75518		38			
72917		72915		41	350	90	1300
75519		75520		42			
75521		75522		46	360		1700
75523		75524		47			
75525		75526		50	370	95	2000
77610		77611		52			
77612		77613		54			2300
75527		75528		55			
77614	Cu-Be	77615	Al-Bron	56	380		
77616		77617		58			2600
75529		75530		60		100	
77618		77619		63			
75531		75532		65			2700
77620		77621		67			
75533		75534		70		105	3000
77622		77623		71	390		4100
77624		77625		75		110	4400
77626		77627		77			4600
77628		77629		80	430	120	4800
77630		77631		82			6800

#### SCAFFOLD

COD.	MAT.	COD.	MAT.	AF mm	O.D. mm	L (mm)	H (mm)	g
79819	Cu-Be	79820	Al-Bron	22	33	300	40	600

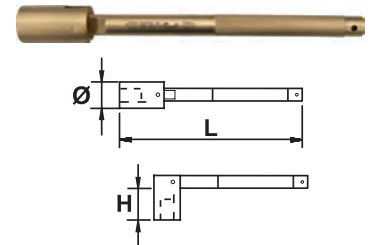

#### DE TUBO DOBLE BOCA / SOCKET DOUBLE ENDED / CLÉ À TUBE FORGÉE DROITE / DOPPEL-STECKSCHLÜSSEL / CHIAVI A TUBO / DIRITTE TUBOLARES BOCA DUPLA / ДВОЙНАЯ ГОЛОВКА

#### MM

COD.	MAT.	COD.	MAT.	AF mm	L (mm)	A (mm)	B (mm)	Ø C (mm)	g
74728		74729		6-7	100	11	13		85
74730		74731		8-9	110	14	16	4	100
74732		74733		10-11	115	17	18		125
74734		74735		12-13	125	19	20	6	185
74736		74737		14-15	130	22	23	8	290
74738		74739		16-17	140	24	26		510
74740	Cu-Be	74741	Al-Bron	18-19	150	27	29	11	570
74742		74743		20-22	155	30	33		710
74744		74745		21-23	165	31	34	12	750
74746		74747		24-26	180	35	37		970
74748		74749		25-28	190	36	40	13	1050
74750		74751		27-29		39	42		1100
74827		74828		30-36	200	43	50		1400

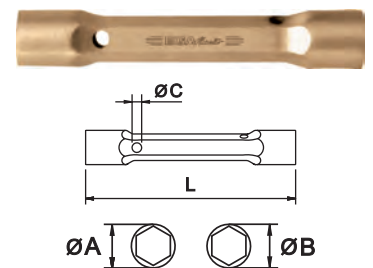

**Cu-Be** Cobre berilio / Beryllium copper / Cuivre beryllium / Kupfer beryllium / Koper beryllium / Rame-berillio / Сплав Медь Бериллий  
**Al-Bron** Aluminio bronze / Aluminium bronze / Alliage aluminium-bronze / Alliage aluminium-bronze / Aluminium brons / Aluminio bronzo / Сплав Аллюминий Бронза

05

ANTICHISPA  
NON-SPARKING  
ANTIDÉFLAGRANT  
FUNKENFREI  
ANTISCINTILLA  
ANTI-DEFLAGRANTE  
ИСКРБЕЗОПАСНЫЙ



Management System  
ISO 9001:2015  
ISO 14001:2015  
www.tuc.com  
ID 091058048

to the  
Management  
Quality

LLAVE DE VASO EN T SIN PASADOR / T-SOCKET WRENCH WITHOUT BAR / DOUILLE EN T SANS GOUPILLE / T-STECKSCHLÜSSEL OHNE STAB / CHIAVI A T ESAGONALI SENZA PERNO / CHAVE DE CAIXA EM T SEM EXTENSOR / КЛЮЧ С Т-ОБРАЗНОЙ ГОЛОВКОЙ ИСКРБЕЗОПАСНЫЙ БЕЗ ВОРОТКА

MM

COD.	MAT.	COD.	MAT.	AF mm	L (mm)	g
77632		77633		8		90
77634		77635		9	130	95
77636		77637		10		105
77638		77639		11	150	120
77640		77641		12		140
77642		77643		13	160	150
77644		77645		14		170
77646		77647		15	170	
77648		77649		16		190
77650		77651		17	190	190
77652		77653		18		320
77654		77655		19	210	370
77656		77657		20		400
77658		77659		21		470
77660		77661		22	240	500
77662		77663		23		600
77664		77665		24		700
77666		77667		25		750
77668		77669		26	270	800
77670		77671		27		850
77672		77673		28		900
77674		77675		29		950
77676		77677		30		
77678		77679		32		1050
77680		77681		33		1100
77682		77683		34	280	1200
77684		77685		35		1350
77686	Cu-Be	77687	Al-Bron	36		1450
77688		77689		37		1500
77690		77691		38		1650
77692		77693		41	285	1950
77694		77695		42		2150
77696		77697		46	300	2300
77698		77699		47		2450
77700		77701		50		3350
77702		77703		52	320	3400
77704		77705		54		3500
77706		77707		55	340	
77708		77709		56		3550
77710		77711		58		4100
77712		77713		60	360	4400
77714		77715		63		4850
77716		77717		65		5150
77718		77719		67	380	5450
77720		77721		70		
77722		77723		71		5900
77724		77725		75		6450
77726		77727		77		6700
77728		77729		80	400	6850
77730		77731		82		7100
77732		77733		85		7500
77734		77735		88	420	7750
77736		77737		90		9000
77738		77739		94		
77740		77741		95	450	9200
77742		77743		100		9250



Cu-Be Cobre berillo / Beryllium copper / Cuivre beryllium / Kupfer beryllium / Koper beryllium / Rame-berillio / Сплав Медь Бериллий  
Al-Bron Aluminio bronze / Aluminium bronze / Alliage aluminium-bronze / Alliage aluminium-bronze / Aluminium brons / Aluminio bronzo / Сплав Алюминий Бронза

Si no encuentra el artículo que necesita, consúltenos en [info@egamaster.com](mailto:info@egamaster.com) o en [www.egamaster.com](http://www.egamaster.com)  
If you can't find the item you look for, please ask us in [info@egamaster.com](mailto:info@egamaster.com) or in [www.egamaster.com](http://www.egamaster.com)  
Si vous ne trouvez pas l'article que vous désirez, consultez-nous à [info@egamaster.com](mailto:info@egamaster.com) ou à [www.egamaster.com](http://www.egamaster.com)

EGAMaster  
ART IN INNOVATION

05

ANTICHISPA  
NON-SPARKING  
ANTIDÉFLAGRANT  
FUNKENFREI  
ANTISCINTILLA  
ANTI-DEFLAGRANTE  
ИСКРБЕЗОПАСНЫЙ



PASADOR PARA LLAVE DE VASO EN "T" / BAR FOR THE T-SOCKET WRENCH / GOUPILLE POUR DOUILLE EN "T" / QUERSTAB FÜR "T" STECK-SCHLÜSSEL / PIN PER CHIAVE A BUSSOLA A T / EXTENSOR PARA CHAVE DE CAIXA EM T / ВОРОТОК ДЛЯ "Т"-ОБРАЗНОГО КЛЮЧА

MM

COD.	MAT.	COD.	MAT.	AF mm	L (mm)	O.D. mm	g
77744		77745		8	120	7	35
77746		77747		9-10	130		50
77748		77749		11-12	140	8	55
77750		77751		13-15	150	9	75
77752		77753		16-18	170	10	100
77754		77755		19-20	180		105
77756		77757		21-22	190	12	165
77758		77759		23-28		13	210
77760	Cu-Be	77761	Al-Bron	29-34	200	16	320
77762		77763		35-37		18	400
77764		77765		38-42	300		750
77766		77767		46-47	350	20	850
77768		77769		50-56	450	25	1700
77770		77771		58-77		28	2400
77772		77773		80-85	500	32	3150
77774		77775		88-100	600	36	4800



LLAVE DE VASO EN "T" / T-SOCKET WRENCH / DOUILLE EN "T" / T-STECKSCHLÜSSEL / CHIAVE A T POLIGONALE / CHAVE DE CAIXA EM T / ГОЛОВКА С Т-ОБРАЗНОЙ РУКОЯТКОЙ

MM

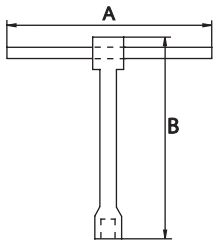

COD.	MAT.	COD.	MAT.	AF mm	L (mm)	A (mm)	B (mm)	g
71370		71381		9	130	130	130	
71371		71382		11	150	140	150	250
71372		71383		14	170	150	170	
71373		71384		17	190	170	190	
71374		71385		19	210	180	210	400
71375		71386		22	240	190	240	700
71376	Cu-Be	71387	Al-Bron	24				
71377		71388		27	270		270	750
71378		71389		30				
71379		71390		32		200		900
72096		72097		36	280		280	950
71380		71391		38				1000

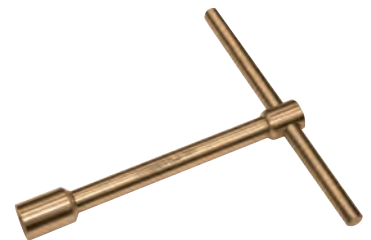

**Cu-Be** Cobre berilio / Beryllium copper / Cuivre beryllium / Kupfer beryllium / Koper beryllium / Rame-berillio / Сплав Медь Бериллий  
**Al-Bron** Aluminio bronze / Aluminium bronze / Alliage aluminium-bronze / Alliage aluminium-bronze / Aluminium brons / Aluminio bronzo / Сплав Алюминий Бронза

■ LLAVE EN "T" / "T" OPEN END WRENCH / CLÉ EN "T" / T-MAULSCHLÜSSEL / CHIAVE FISSA E T / CHAVE FIXA EM T / РОЖКОВЫЙ КЛЮЧ С Т-ОБРАЗНОЙ РУКОЯТКОЙ

■ MM

COD.	MAT.	COD.	MAT.	AF mm	L (mm)	g
73951	Cu-Be	73952	Al-Bron	8	210	130
73953		73954		10		140
73955		73956		12		145
73957		73958		14		450



■ HEXAGONAL EN "T" / "T" HEXAGONAL WRENCH / CLÉ HEXAGONALE EN "T" / T-HEX SCHLÜSSEL / CHIAVE ESAGONALE A T / CHAVE HEXAGONAL EM T / ШЕСТИГРАННИК С Т-ОБРАЗНОЙ РУКОЯТКОЙ

■ MM

COD.	MAT.	COD.	MAT.	AF mm	L (mm)	g
74192	Cu-Be	74193	Al-Bron	10	150	250
74194		74195		12	170	280
74196		74197		14		380
74198		74199		17	190	450
74200		74201		19	220	600
74202		74203		22	240	650
74204		74205		24	260	900
74206		74207		27		950
74208		74209		30	280	1200
74210		74211		32		1400
74212		74213		36	300	1700
74214		74215		41		1900



EGGA Master  
ART IN INNOVATION

LLAVES HEXAGONALES DE BOLA / BALLPOINT HEXAGONAL KEYS / CLÉS MÂLES À TÊTE SPHÉRIQUE / KUGELKOPF INBUSSCHLÜSSEL / CHIAVI ESAGONALI CON TESTA SFERICA / CHAVES HEXAGONAIS ESFERICAS / ШЕСТИГРАННЫЕ КЛЮЧИ С ШАРОВОЙ ГОЛОВКОЙ

STANDARD

MM



COD.	MAT.	COD.	MAT.	AF mm	L (mm)	A (mm)	g
75553		75554		2	50	16	7
72177		72184		3	63	20	11
72178		72185		4	70	25	14
72179		72186		5	80	28	43
72180		72187		6	90	32	
75555	Cu-Be	75556	Al-Bron	7	95	34	45
72181		72188		8	100	36	
75557		75558		9	106	38	60
72182		72189		10	112	40	80
75559		75560		11	118	42	100
72183		72190		12	125	45	127

INCH

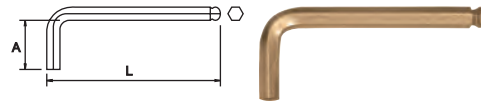

COD.	MAT.	COD.	MAT.	AF inch	L (mm)	A (mm)	g
36250		36251		1/8	66	20	10,5
36252		36253		5/32	74	25	13,5
36254		36255		3/16	85	28	40,5
36256	Cu-Be	36257	Al-Bron	7/32	96	32	
36258		36259		1/4	102	34	43
36260		36261		5/16	108	36	
36262		36263		3/8	122	40	76

SERIE LARGA / LONG PATTERN / SÉRIE LONGUE / LANGE SCHNKE / SERIE LUNGA / SERIE LONGA / ДЛИННЫЕ

MM



COD.	MAT.	COD.	MAT.	AF mm	L (mm)	A (mm)	g
77562		77563		2	101	16	15
70410		71354		3	128	20	21
70411		71355		4	143	25	25
70412		71356		5	160	28	43
70413		71357		6	182	32	61
77566	Cu-Be	77567	Al-Bron	7	195	34	92
70414		71358		8	209	36	150
77568		77569		9	224	38	200
70415		71359		10	238	40	250
70416		71360		12	270	45	440

INCH

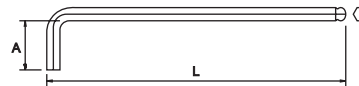

COD.	MAT.	COD.	MAT.	AF inch	L (mm)	A (mm)	g
36264		36265		1/8	128	20	21
36266		36267		5/32	143	25	25
36268		36269		3/16	160	28	43
36270	Cu-Be	36271	Al-Bron	7/32	182	32	61
36272		36273		1/4	195	34	92
36274		36275		5/16	209	36	150
36276		36277		3/8	238	40	250

# 05

**ANTICHISPA  
NON-SPARKING  
ANTIDÉFLAGRANT  
FUNKENFREI  
ANTISCINTILLA  
ANTI-DEFLAGRANTE  
ИСКРБЕЗОПАСНЫЙ**



■ **LLAVES HEXAGONALES / HEXAGONAL KEYS / CLÉS MÂLES / INBUSSCHLÜSSEL / CHIAVI ESAGONALI / CHAVES HEXAGONAIS / ШЕСТИГРАННЫЕ КЛЮЧИ**

■ **STANDARD**

■ **MM**



■ **INCH**



COD.	MAT.	COD.	MAT.	AF mm	L (mm)	A (mm)	g	
72239		72238		1,5	47	14	6,5	
70391		71287		2	52	16		
72929		72928		2,5	60	18		8,5
70392		71288		3	65	20		11
70393		71289		4	75	25		14
70394		71290		5	85	28		41
74357		74358		5,5	85	26		
70395		71291		6	95	32		43
70396		71292		7	100	34		
70397		71293		8	110	36		55
70398		71294		9	115	38		
70399		71295		10	120	40	75	
72241		72240		11	130	42	95	
70400		71296		12	140	45	120	
72243		72242		13	145	50	152	
70401		71297		14	155	55	190	
74629		74634		15	160	60	230	
72931	Cu-Be	72930	Al-Bron	16	170	60	270	
70402		71298		17	175	65	320	
72245		72244		18	190	70	380	
70403		71299		19	200	70	450	
74630		74631		20	205	75	540	
74632		74633		21	215	75	600	
70404		71300		22	220	80	690	
75228		75229		23	240	85	790	
70405		71301		24	250	90	910	
75230		75231		25	255	95	1020	
75232		75233		26	265	95	1150	
70406		71302		27	275	100	1300	
75234		75235		28	290	110	1500	
75236		75237		29	300	115	1600	
75238		75239		30	310	120	1800	
70407		71303		32	350	125	2300	
70408		71304		36	400	140	3200	
70409		71305		41	430	150	4600	

COD.	MAT.	COD.	MAT.	AF inch	L (mm)	A (mm)	g	
75537		75538		1/16	47	14	6,5	
72933		72932		5/64	52	16		
72935		72934		3/32	58	18		8,5
75539		75540		7/64	66	20		11
71306		71330		1/8	66	20		14
71307		71331		9/64	75	25		
71308		71332		5/32	75	25		41
71309		71333		3/16	85	28		
71310		71334		7/32	95	32		43
71311		71335		1/4	100	34		
75541		75542		9/32	100	34	55	
71312		71336		5/16	110	36		
75543		75544		11/32	110	36	75	
71313		71337		3/8	115	38		
71314		71338		7/16	130	42	95	
71315		71339		1/2	140	45	120	
71316	Cu-Be	71340	Al-Bron	9/16	155	55	190	
71317		71341		5/8	160	60	230	
71318		71342		11/16	175	65	320	
71319		71343		3/4	200	70	450	
75545		75546		13/16	210	75	540	
71320		71344		7/8	220	80	690	
75547		75548		15/16	240	85	790	
71321		71345		1	255	95	1020	
71322		71346		1.1/16	265	95	1200	
71323		71347		1.1/8	290	110	1500	
75549		75550		1.3/16	310	120	1800	
71324		71348		1.1/4	350	125	2300	
71325		71349		1.5/16				
71326		71350		1.3/8	400	140	3200	
71327		71351		1.7/16				
71328		71352		1.1/2	430	150	4600	
71329		71353		1.5/8				

■ **SET**

COD.	MAT.	PCS.	COD. PCS.	mm	g
74352	Cu-Be	10	72239, 70391, 72929, 70392, 70393, 70394, 74357, 70395, 70397, 70399	1,5-2-2,5-3-4-5-5,5-6-8-10	370
74353	Al-Bron		72238, 71287, 72928, 71288, 71289, 71290, 74358, 71291, 71293, 71295		



**Cu-Be** Cobre berilio / Beryllium copper / Cuivre beryllium / Kupfer beryllium / Koper beryllium / Rame-berillio / Сплав Медь Бериллий  
**Al-Bron** Aluminio bronze / Aluminium bronze / Alliage aluminium-bronze / Alliage aluminium-bronze / Aluminium brons / Aluminio bronzo / Сплав Алюминий Бронза

Si no encuentra el artículo que necesita, consúltenos en [info@egamaster.com](mailto:info@egamaster.com) o en [www.egamaster.com](http://www.egamaster.com)  
 If you can't find the item you look for, please ask us in [info@egamaster.com](mailto:info@egamaster.com) or in [www.egamaster.com](http://www.egamaster.com)  
 Si vous ne trouvez pas l'article que vous desirez, consultez-nous a [info@egamaster.com](mailto:info@egamaster.com) ou a [www.egamaster.com](http://www.egamaster.com)



05

**ANTICHISPA  
NON-SPARKING  
ANTIDÉFLAGRANT  
FUNKENFREI  
ANTISCINTILLA  
ANTI-DEFLAGRANTE  
ИСКРОБЕЗОПАСНЫЙ**



## ■ TORX®\*

COD.	MAT.	COD.	MAT.		L (mm)	A (mm)	
35830	Cu-Be	35831	Al-Bron	T6	42	16	6,5
35832		T7					
35834		T8					
35836		T9					
76134		76135		T10	51	17	9
76136		76137		T15	54	18	
76138		76139		T20	57	20	
76140		76141		T25	60	20	
76133		76144		T27	64	21	
76142		76143		T30	70	24	
36428		36429		T40	76	26	

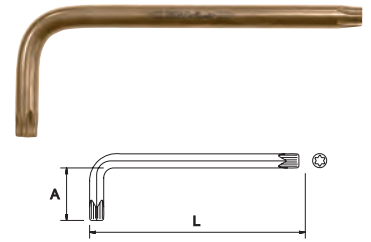

## ■ TAMPER TORX

COD.	MAT.	COD.	MAT.		L (mm)	A (mm)			
36430	Cu-Be	36431	Al-Bron	TT8	42	16	6,5		
36432		TT9							
35774		35775		TT10				51	17
35776		35777		TT15				54	18
35778		35779		TT20	57	20	12		
35780		35781		TT25	60	20			
35782		35783		TT27	64	21			
35784		35785		TT30	70	24			
35786		35787		TT40	76	26			

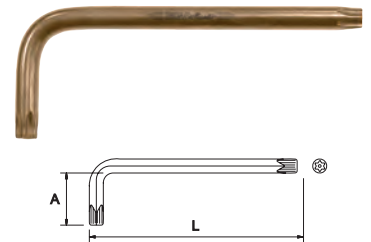

**LLAVE DINAMOMÉTRICA / TORQUE WRENCH / CLÉ DYNAMOMETRIQUE / DREHMOMENTSCHLÜSSEL / CHIAVE DINAMOMETRICA / CHAVE DINAMOMETRICA / ДИНАМОМЕТРИЧЕСКИЙ КЛЮЧ**

COD.	MAT.	COD.	MAT.		L (mm)	N.m	
72171	Cu-Be	72174	Al-Bron	3/8	310	100	600
72172		72175		1/2	490	300	1250
72173		72176		3/4	560	500	1700



G12

**ESPECIFICACIONES TÉCNICAS / TECHNICAL SPECIFICATION / DÉTAILS TECHNIQUES**

Precisión / Accuracy / Exactitude 6%

COD.	MAT.	COD.	MAT.		L (mm)	N.m	
74810	Cu-Be	74806	Al-Bron	3/8	360	5-45	950
74821		74871		1/2	500	40-200	1300
74823		74874		3/4	600	60-260	1450
75267		75274		1	1050	150-670	5700
74879		74884		1	1250	200-900	10000



G12

**ESPECIFICACIONES TÉCNICAS / TECHNICAL SPECIFICATION / DÉTAILS TECHNIQUES**

Precisión / Accuracy / Exactitude 6%

\*Para tornillos TORX® (Marca registrada por Acument Intellectual Properties, LLC, Troy, Mich., US) / \*For screws TORX® (Aument Intellectual Properties, LLC, Troy, Mich., US registered trademark) / \*Pour vis TORX® (Marque enregistrée par Acument Intellectual Properties, LLC, Troy, Mich., US)

**Cu-Be** Cobre berilio / Beryllium copper / Cuivre beryllium / Kupfer beryllium / Koper beryllium / Rame-berilio / Сплав Медь Бериллий

**Al-Bron** Aluminio bronce / Aluminium bronze / Alliage aluminium-bronze / Alliage aluminium-bronze / Aluminium brons / Aluminio bronzo / Сплав Аллюминий Бронза

**G12** GARANTIA 12 MESES / 12 MONTHS OF WARRANTY / 12 MOIS DE GARANTIE / 12 MONATEN GARANTIE / 12 MAANDEN GARANTIE / 12 MESI DI GARANZIA / 12 МЕСЯЦЕВ ГАРАНТИЯ



■ LLAVES DE VASO / SOCKET WRENCHES / DOUILLES / STECKSCHLÜSSEL / BUSSOLE / CHAVES DE CAIXA / ГОЛОВКИ

■ 1/4"

■ STANDARD

■ MM

■ 6 PT.



COD.	MAT.	COD.	MAT.	AP mm	L (mm)	Pt	g
71909		71930		4			
75562		75563		4,5			
71910		71931		5		10	
75551		75552		5,5			
71911		71932		6	25		
71912		71933		7		12	
71913		71934		8			
71914		71935		9		15	
71915	Cu-Be	71936	Al-Bron	10		6	
71916		71937		11		20	
71917		71938		12			
71918		71939		13	26	25	
71919		71940		14			
75564		75565		15			
75566		75567		16		30	
75568		75569		17	27		
75570		75571		18		35	
75572		75573		19			

■ 12 PT.



COD.	MAT.	COD.	MAT.	AP mm	L (mm)	Pt	g
74406		74427		4			
75576		75577		4,5			
74407		74428		5		10	
75578		75579		5,5			
74408		74429		6	25		
74409		74430		7		12	
74410		74431		8			
74411		74432		9		15	
74412	Cu-Be	74433	Al-Bron	10		12	
74413		74434		11		20	
74414		74435		12			
74415		74436		13	26	25	
74416		74437		14			
75580		75581		15			
75582		75583		16		30	
75584		75585		17	27		
75586		75587		18		35	
75588		75589		19			

■ INCH

■ 6 PT.



COD.	MAT.	COD.	MAT.	AP inch	L (mm)	Pt	g
75574		75575		5/32			
71920		71941		3/16			
71921		71942		7/32	25	10	
71922		71943		1/4			
71923		71944		9/32			
71924	Cu-Be	71945	Al-Bron	5/16		6	
71925		71946		11/32		15	
71926		71947		3/8			
71927		71948		7/16	28	20	
71928		71949		1/2		25	
71929		71950		9/16			

■ 12 PT.



COD.	MAT.	COD.	MAT.	AP inch	L (mm)	Pt	g
75590		75591		5/32			
74417		74438		3/16			
74418		74439		7/32	25	10	
74419		74440		1/4			
74420		74441		9/32			
74421	Cu-Be	74442	Al-Bron	5/16		12	
74422		74443		11/32		15	
74423		74444		3/8			
74424		74445		7/16	28	20	
74425		74446		1/2		25	
74426		74447		9/16			

Cu-Be Cobre berilio / Beryllium copper / Cuivre beryllium / Kupfer beryllium / Koper beryllium / Rame-berillio / Сплав Медь Бериллий  
Al-Bron Aluminio bronze / Aluminium bronze / Alliage aluminium-bronze / Alliage aluminium-bronze / Aluminium brons / Aluminio bronzo / Сплав Алюминий Бронза

Si no encuentra el artículo que necesita, consúltenos en [info@egamaster.com](mailto:info@egamaster.com) o en [www.egamaster.com](http://www.egamaster.com)  
If you can't find the item you look for, please ask us in [info@egamaster.com](mailto:info@egamaster.com) or in [www.egamaster.com](http://www.egamaster.com)  
Si vous ne trouvez pas l'article que vous désirez, consultez-nous a [info@egamaster.com](mailto:info@egamaster.com) ou a [www.egamaster.com](http://www.egamaster.com)

05

ANTICHISPA  
NON-SPARKING  
ANTIDÉFLAGRANT  
FUNKENFREI  
ANTISCINTILLA  
ANTI-DEFLAGRANTE  
ИСКРБЕЗОПАСНЫЙ



Management System  
ISO 9001:2015  
ISO 14001:2015  
www.tsc.com  
ID: 0910098048



1/4"

■ SERIE LARGA / LONG SOCKETS / SÉRIE LONGUE / LANGE SERIE / SERIE LUNGA / SERIE LONGA / ВЫСОКАЯ СЕРИЯ

■ MM

■ 6 PT.

■ 12 PT.



COD.	MAT.	COD.	MAT.	AP mm	L (mm)	Pt	g
78741		78742		4			
78743		78744		4,5			
78745		78746		5			
78747		78748		5,5			38
78749		78750		6			
78751		78752		7			
78753		78754		8			40
78755		78756		9			44
78757		78758		10			47
78759	Cu-Be	78760	Al-Bron	11	50	6	
78761		78762		12			50
78763		78764		13			
78765		78766		14			55
78767		78768		15			60
78769		78770		16			70
78771		78772		17			80
78773		78774		18			85
78775		78776		19			95

COD.	MAT.	COD.	MAT.	AP mm	L (mm)	Pt	g
78799		78800		4			
78801		78802		4,5			
78803		78804		5			
78805		78806		5,5			38
78807		78808		6			
78809		78810		7			
78811		78812		8			40
78813		78814		9			44
78815		78816		10			47
78817	Cu-Be	78818	Al-Bron	11	50	12	
78819		78820		12			50
78821		78822		13			
78823		78824		14			55
78825		78826		15			60
78827		78828		16			70
78829		78830		17			80
78831		78832		18			85
78833		78834		19			95

■ INCH

■ 6 PT.

■ 12 PT.



COD.	MAT.	COD.	MAT.	AP inch	L (mm)	Pt	g
78777		78778		5/32			
78779		78780		3/16			
78781		78782		7/32			38
78783		78784		1/4			
78785		78786		9/32			
78787	Cu-Be	78788	Al-Bron	5/16	50	6	40
78789		78790		11/32			44
78791		78792		3/8			47
78793		78794		7/16			50
78795		78796		1/2			
78797		78798		9/16			55

COD.	MAT.	COD.	MAT.	AP inch	L (mm)	Pt	g
78835		78836		5/32			
78837		78838		3/16			
78839		78840		7/32			38
78841		78842		1/4			
78843		78844		9/32			
78845	Cu-Be	78846	Al-Bron	5/16	50	12	40
78847		78848		11/32			44
78849		78850		3/8			47
78851		78852		7/16			50
78853		78854		1/2			
78855		78856		9/16			55

**Cu-Be** Cobre berilio / Beryllium copper / Cuivre beryllium / Kupfer beryllium / Koper beryllium / Rame-berillio / Сплав Медь Бериллий  
**Al-Bron** Aluminio bronze / Aluminium bronze / Alliage aluminium-bronze / Alliage aluminium-bronze / Aluminium brons / Aluminio bronzo / Сплав Аллюминий Бронза



1/4"

LLAVE DE CARRACA REVERSIBLE / REVERSIBLE RATCHET HANDLE / CLÉ À CLIQUET RÉVERSIBLE / UMSCHALTKNARRE / CHIAVE A CRICCO REVERSIBILE / ROQUETE REVERSIVEL / РЕВЕРСИВНАЯ ТРЕЩЕТКА

COD.	MAT.	COD.	MAT.		L (mm)	
71955	Cu-Be	71956	Al-Bron	1/4	130	400





ALARGADERA / EXTENSION / RALLONGE / VERLÄNGERUNG / PROLUNGA / EXTENÇÃO / УДЛИНИТЕЛЬ

COD.	MAT.	COD.	MAT.		L (inch)	
71959	Cu-Be	71961	Al-Bron	1/4	4	200
71960		71962			8	400





CARRACA MACHO-HEMBRA / MALE-FEMALE RATCHET / CLIQUET MÂLE-FEMELLE / RATSCHÉ DOPELT FUNKTION / CRICCO MASCHIO-FEMMINA / ROQUETE MACHO-FÊMEA / ТРЕЩЕТКА ПАПА-МАМА

COD.	MAT.	COD.	MAT.		L (mm)	
73722	Cu-Be	73723	Al-Bron	1/4	200	350





MANGO CORREDIZO EN "T" / SLIDING "T" HANDLE / POIGNÉE COULISSANTE / T-GLEITGRIF / ASTA CON QUADRO SCORREVOLE "T" / CABO "T" CORREDIÇO / Т-ОБРАЗНАЯ С ПЛАВАЮЩЕЙ РУЧКОЙ

COD.	MAT.	COD.	MAT.		L (inch)	
71957	Cu-Be	71958	Al-Bron	1/4	10	250





ARTICULACIÓN UNIVERSAL / UNIVERSAL JOINT / CARDAN UNIVERSEL / KARDANGELNENK / SNODO CARDANICO / CARDAN UNIVERSAL / КАРДАННОЕ СОЕДИНЕНИЕ

COD.	MAT.	COD.	MAT.		L (mm)	
71953	Cu-Be	71954	Al-Bron	1/4	55	150





ADAPTADOR / ADAPTER / ADAPTATEUR / VERBINDUNGSTEILE / ADATTATORE / PEÇA DE CONEXÃO / АДАПТЕР

COD.	MAT.	COD.	MAT.			
75718	Cu-Be	75719	Al-Bron	1/4-3/8		20
71951		71952		1/4-1/2		100



PUNTA HEXAGONAL CON VASO / HEX BIT SOCKET / EMBOUT HEXAGONAL À DOUILLE / HEX SCHRAUBENDREHEREINSATZ / PUNTA ESAGONALE CON BUSSOLA / PONTA HEXAGONAL COM CHAVE DE CAIXA / ШЕСТИГРАННАЯ ГОЛОВКА

COD.	MAT.	COD.	MAT.			L (mm)	
73692	Cu-Be	73693	Al-Bron	1/4	3	55	20
73694		73695			4		
73696		73697			5		
73698		73699			6	65	25
73700		73701			7		
73702		73703			8		
73704		73705			9		
73706		73707			10	60	



DESTORNILLADOR PORTAVASOS / SOCKET HOLDER / TOURNEVIS PORTE DOUILLE / SCHRAUBENDREHERHALTER / CACCIAVITI PORTABUSSOLE / CHAVE PORTA CHAVES DE CAIXA / ДЕРЖАТЕЛЬ ГОЛОВОК

COD.	MAT.	COD.	MAT.		L (mm)		
73731	Cu-Be	73732	Al-Bron	1/4	195	55	60



Cu-Be Cobre berilio / Beryllium copper / Cuivre beryllium / Kupfer beryllium / Koper beryllium / Rame-berillio / Сплав Медь Бериллий  
Al-Bron Aluminio bronze / Aluminium bronze / Alliage aluminium-bronze / Alliage aluminium-bronze / Aluminium brons / Aluminio bronzo / Сплав Алюминий Бронза

# 05

**ANTICHISPA  
NON-SPARKING  
ANTIDÉFLAGRANT  
FUNKENFREI  
ANTISCINTILLA  
ANTI-DEFLAGRANTE  
ИСКРБЕЗОПАСНЫЙ**



- 3/8"
- STANDARD
- MM
- 6 PT.



- 12 PT.



COD.	MAT.	COD.	MAT.	AP mm	L (mm)	Pt	g			
75592		75593		5	28	20				
75594		75595		5,5						
75596		75597		6						
75598		75599		7						
75600		75601		8						
75602		75603		9						
75604		75605		10						
75606	Cu-Be	75607	Al-Bron	11				6	35	
75608		75609								
75610		75611								
75612		75613								
75614		75615								
75616		75617								
75618		75619								
75620		75621								
75622		75623								
						12	32			
				13						
				14						
				15						
				16						
				17						
				19						
				20						

COD.	MAT.	COD.	MAT.	AP mm	L (mm)	Pt	g			
75646		75647		5	28	20				
75648		75649		5,5						
75650		75651		6						
75652		75653		7						
75654		75655		8						
75656		75657		9						
75658		75659		10						
75660	Cu-Be	75661	Al-Bron	11				12	35	
75662		75663								
75664		75665								
75666		75667								
75668		75669								
75670		75671								
75672		75673								
75674		75675								
75676		75677								
						13	32			
				14						
				15						
				16						
				17						
				19						
				20						

- INCH
- 6 PT.



- 12 PT.



COD.	MAT.	COD.	MAT.	AP inch	L (mm)	Pt	g					
75624		75625		5/16	32	35						
75626		75627		3/8								
75628		75629		7/16								
75630		75631		1/2								
75632		75633		9/16								
75634	Cu-Be	75635	Al-Bron	5/8				6	65			
75636		75637										
75638		75639										
75640		75641										
75642		75643										
75644		75645										
						11/16	35				70	
						3/4						
						13/16						
						7/8						
				15/16								

COD.	MAT.	COD.	MAT.	AP inch	L (mm)	Pt	g					
75678		75679		5/16	32	35						
75680		75681		3/8								
75682		75683		7/16								
75684		75685		1/2								
75686		75687		9/16								
75688	Cu-Be	75689	Al-Bron	5/8				12	65			
75690		75691										
75692		75693										
75694		75695										
75696		75697										
75698		75699										
						11/16	35				70	
						3/4						
						13/16						
						7/8						
				15/16								

**Cu-Be** Cobre berilio / Beryllium copper / Cuivre beryllium / Kupfer beryllium / Koper beryllium / Rame-berillio / Сплав Медь Бериллий  
**Al-Bron** Aluminio bronze / Aluminium bronze / Alliage aluminium-bronze / Alliage aluminium-bronze / Aluminium brons / Aluminio bronzo / Сплав Аллюминий Бронза

05

ANTICHISPA  
NON-SPARKING  
ANTIDÉFLAGRANT  
FUNKENFREI  
ANTISCINTILLA  
ANTI-DEFLAGRANTE  
ИСКРБЕЗОПАСНЫЙ



3/8"

■ SERIE LARGA / LONG SOCKETS / SÉRIE LONGUE / LANGE SERIE / SERIE LUNGA / SERIE LONGA / ВЫСОКАЯ СЕРИЯ

■ MM

■ 6 PT.

■ 12 PT.



COD.	MAT.	COD.	MAT.	AP mm	L (mm)	Pt	g
78857		78858		5			
78859		78860		5,5			
78861		78862		6			
78863		78864		7			85
78865		78866		8			
78867		78868		9			
78869		78870		10			90
78871	Cu-Be	78872	Al-Bron	11	60	6	95
78873		78874		12			100
75966		75967		13			105
78875		78876		14			
78877		78878		15			110
78879		78880		16			115
78881		78882		17			120
78883		78884		19			130
78885		78886		20			135

COD.	MAT.	COD.	MAT.	AP mm	L (mm)	Pt	g
78909		78910		5			
78911		78912		5,5			
78913		78914		6			
78915		78916		7			85
78917		78918		8			
78919		78920		9			
78921		78922		10			90
78923	Cu-Be	78924	Al-Bron	11	60	12	95
78925		78926		12			100
78927		78928		13			105
78929		78930		14			
78931		78932		15			110
78933		78934		16			115
78935		78936		17			120
78937		78938		19			130
78939		78940		20			135

■ INCH

■ 6 PT.

■ 12 PT.



COD.	MAT.	COD.	MAT.	AP inch	L (mm)	Pt	g
78887		78888		5/16			85
78889		78890		3/8			100
78891		78892		7/16			
78893		78894		1/2			105
78895		78896		9/16			
78897	Cu-Be	78898	Al-Bron	5/8	60	6	115
78899		78900		11/16			125
78901		78902		3/4			130
78903		78904		13/16			145
78905		78906		7/8			155
78907		78908		15/16			190

COD.	MAT.	COD.	MAT.	AP inch	L (mm)	Pt	g
78941		78942		5/16			85
78943		78944		3/8			100
78945		78946		7/16			
78947		78948		1/2			105
78949		78950		9/16			
78951	Cu-Be	78952	Al-Bron	5/8	60	12	115
78953		78954		11/16			125
78955		78956		3/4			130
78957		78958		13/16			145
78959		78960		7/8			155
78961		78962		15/16			190

**Cu-Be** Cobre berilio / Beryllium copper / Cuivre beryllium / Kupfer beryllium / Koper beryllium / Rame-berillio / Сплав Медь Бериллий  
**Al-Bron** Aluminio bronze / Aluminium bronze / Alliage aluminium-bronze / Alliage aluminium-bronze / Aluminium brons / Aluminio bronzo / Сплав Алюминий Бронза

Si no encuentra el artículo que necesita, consúltenos en [info@egamaster.com](mailto:info@egamaster.com) o en [www.egamaster.com](http://www.egamaster.com)  
 If you can't find the item you look for, please ask us in [info@egamaster.com](mailto:info@egamaster.com) or in [www.egamaster.com](http://www.egamaster.com)  
 Si vous ne trouvez pas l'article que vous desirez, consultez-nous a [info@egamaster.com](mailto:info@egamaster.com) ou a [www.egamaster.com](http://www.egamaster.com)

3/8"

LLAVE DE CARRACA REVERSIBLE / REVERSIBLE RATCHET HANDLE / CLÉ À CLIQUET RÉVERSIBLE / UMSCHALTKNARRE / CHIAVE A CRICCO REVERSIBILE / ROQUETE REVERSIVEL / РЕВЕРСИВНАЯ ТРЕЩЕТКА

COD.	MAT.	COD.	MAT.	AF inch	L (mm)	g
75700	Cu-Be	75701	Al-Bron	3/8	200	400



ALARGADERA / EXTENSION / RALLONGE / VERLÄNGERUNG / PROLUNGA / EXTENÇÃO / УДЛИНИТЕЛЬ

COD.	MAT.	COD.	MAT.	AF inch	L (inch)	g
75702	Cu-Be	75703	Al-Bron	3/8	8	400
75704		75705			10	500



CARRACA MACHO-HEMBRA / MALE-FEMALE RATCHET / CLIQUET MALE-FEMELLE / RATSCHÉ DOPELT FUNKTION / CRICCO MASCHIO-FEMMINA / ROQUETE MACHO-FÊMEA / ТРЕЩЕТКА ПАПА-МАМА

COD.	MAT.	COD.	MAT.	AF inch	L (mm)	g
75706	Cu-Be	75707	Al-Bron	3/8	200	350



MANGO CORREDIZO EN "T" / SLIDING "T" HANDLE / POIGNÉE COULISSANTE / T-GLEITGRIF / ASTA CON QUADRO SCORREVOLE "T" / CABO "T" CORREDIÇO / Т-ОБРАЗНАЯ С ПЛАВАЮЩЕЙ РУЧКОЙ

COD.	MAT.	COD.	MAT.	AF inch	L (inch)	g
75708	Cu-Be	75709	Al-Bron	3/8	10	250



MANGO ARTICULADO / SWIVEL HANDLE / MANCHE ARTICULÉ / GELENKGRIF / MANICO ARTICOLATO / CABO ARTICULADO / ГИБКАЯ РУКОЯТКА

COD.	MAT.	COD.	MAT.	AF inch	L (mm)	g
75710	Cu-Be	75711	Al-Bron	3/8	175	220



MANGO ACODADO / OFFSET HANDLE / MANCHE CONTRE COUDÉ / GEKRÖPFTE HANDGRIF / DOPPIO MANICO / CABO DESALINHADO / ИЗОГНУТАЯ РУКОЯТКА

COD.	MAT.	COD.	MAT.	AF inch	L (mm)	g
75712	Cu-Be	75713	Al-Bron	3/8	200	300



ARTICULACIÓN UNIVERSAL / UNIVERSAL JOINT / KARDAN UNIVERSEL / KARDANGELLENK / SNODO CARDANICO / CARDAN UNIVERSAL / КАРДАННОЕ СОЕДИНЕНИЕ

COD.	MAT.	COD.	MAT.	AF inch	L (mm)	g
75714	Cu-Be	75715	Al-Bron	3/8	70	150



ADAPTADOR / ADAPTER / ADAPTATEUR / VERBINDUNGSTEILE / ADATTATORE / PEÇA DE CONEXÃO / АДАПТЕР

COD.	MAT.	COD.	MAT.	AF inch	AF inch	g
75716	Cu-Be	75717	Al-Bron	3/8	1/4	20
75722		75723		3/8	1/2	50



# 05

**ANTICHISPA  
NON-SPARKING  
ANTIDÉFLAGRANT  
FUNKENFREI  
ANTISCINTILLA  
ANTI-DEFLAGRANTE  
ИСКРБЕЗОПАСНЫЙ**



- 1/2"
- STANDARD
- MM
- 6 PT.

- 12 PT.



COD.	MAT.	COD.	MAT.	AF mm	L (mm)	Pt	g
70319		71158		6			
70320		71159		7		60	
70321		71160		8			
70322		71161		9			
70323		71162		10		70	
70324		71163		11	40		
70325		71164		12			
70326		71165		13		80	
70327		71166		14			
70328		71167		15			
70329		71168		16		90	
70330		71169		17			
70331		71170		18			
70332		71171		19	42	100	
70333	Cu-Be	71172	Al-Bron	20		6	
70334		71173		21		120	
70335		71174		22		130	
70336		71175		23	43	140	
70337		71176		24		170	
70338		71177		25		180	
70339		71178		26		190	
70340		71179		27			
70341		71180		28			
70342		71181		29	46	200	
70343		71182		30			
70344		71183		32			
74693		74692		34	50	350	
74325		74326		36		400	
79211		79212		41	55	590	

COD.	MAT.	COD.	MAT.	AF mm	L (mm)	Pt	g
74448		74475		6			
74449		74476		7		60	
74450		74477		8			
74451		74478		9			
74452		74479		10		70	
74453		74480		11	40		
74454		74481		12			
74455		74482		13		80	
74456		74483		14			
74457		74484		15			
74458		74485		16		90	
74459		74486		17			
74460		74487		18			
74461		74488		19	42	100	
74462	Cu-Be	74489	Al-Bron	20		12	
74463		74490		21		120	
74464		74491		22		130	
74465		74492		23	43	140	
74466		74493		24		170	
74467		74494		25		180	
74468		74495		26		190	
74469		74496		27			
74470		74497		28			
74471		74498		29	46	200	
74472		74499		30			
74473		74500		32			
75300		75301		34	50	350	
74474		74501		36		450	
36452		36453		41	55	590	

**Cu-Be** Cobre berilio / Beryllium copper / Cuivre beryllium / Kupfer beryllium / Koper beryllium / Rame-berillio / Сплав Медь Бериллий  
**Al-Bron** Aluminio bronce / Aluminium bronze / Alliage aluminium-bronze / Alliage aluminium-bronze / Aluminium brons / Aluminio bronzo / Сплав Аллюминий Бронза

Si no encuentra el artículo que necesita, consúltenos en [info@egamaster.com](mailto:info@egamaster.com) o en [www.egamaster.com](http://www.egamaster.com)  
 If you can't find the item you look for, please ask us in [info@egamaster.com](mailto:info@egamaster.com) or in [www.egamaster.com](http://www.egamaster.com)  
 Si vous ne trouvez pas l'article que vous desirez, consultez-nous a [info@egamaster.com](mailto:info@egamaster.com) ou a [www.egamaster.com](http://www.egamaster.com)



# 05

**ANTICHISPA  
NON-SPARKING  
ANTIDÉFLAGRANT  
FUNKENFREI  
ANTISCINTILLA  
ANTI-DEFLAGRANTE  
ИСКРБЕЗОПАСНЫЙ**



1/2"

■ STANDARD

■ INCH

■ 6 PT.



■ 12 PT.



COD.	MAT.	COD.	MAT.	AP inch	L (mm)	Pt	g
71184		71202		1/4			
71185		71203		5/16			60
35840		35841		11/32			
71186		71204		3/8			70
71187		71205		7/16	40		
71188		71206		1/2			
71189		71207		9/16			80
71190		71208		19/32			
71191		71209		5/8			
71192		71210		11/16			
35842		35843		23/32	42		90
71193	Cu-Be	71211	Al-Bron	3/4		6	
71194		71212		25/32			100
71195		71213		13/16			120
71196		71214		7/8	43		
35844		35845		29/32			140
71197		71215		15/16			150
71198		71216		1			200
71199		71217		1.1/16			
71200		71218		1.1/8	46		
77788		77789		1.3/16			250
71201		71219		1.1/4			
74882		74883		1.7/16	47		
78983		78984		1.1/2			300

COD.	MAT.	COD.	MAT.	AP inch	L (mm)	Pt	g
74502		74520		1/4			
74503		74521		5/16			60
35850		35851		11/32			
74504		74522		3/8			70
74505		74523		7/16	40		
74506		74524		1/2			
74507		74525		9/16			80
74508		74526		19/32			
74509		74527		5/8			
74510		74528		11/16			
35852		35853		23/32	42		90
74511	Cu-Be	74529	Al-Bron	3/4		12	
74512		74530		25/32			100
74513		74531		13/16			120
74514		74532		7/8	43		
35854		35855		29/32			140
74515		74533		15/16			150
74516		74534		1			200
74517		74535		1.1/16			
74518		74536		1.1/8	46		
77790		77791		1.3/16			250
74519		74537		1.1/4			
75302		75304		1.7/16	47		
36446		36447		1.1/2			300

**Cu-Be** Cobre berilio / Beryllium copper / Cuivre beryllium / Kupfer beryllium / Koper beryllium / Rame-berillio / Сплав Медь Бериллий  
**Al-Bron** Aluminio bronce / Aluminium bronze / Alliage aluminium-bronze / Alliage aluminium-bronze / Aluminium brons / Aluminio bronzo / Сплав Алюминий Бронза



05

**ANTICHISPA**  
**NON-SPARKING**  
**ANTIDÉFLAGRANT**  
**FUNKENFREI**  
**ANTISCINTILLA**  
**ANTI-DEFLAGRANTE**  
**ИСКРБЕЗОПАСНЫЙ**



1/2"

■ **SERIE LARGA / LONG SOCKETS / SÉRIE LONGUE / LANGE SERIE / SERIE LUNGA / SERIE LONGA / ВЫСОКАЯ СЕРИЯ**■ **MM**■ **6 PT.**■ **12 PT.**

COD.	MAT.	COD.	MAT.	AF mm	L (mm)	Pt	g	COD.	MAT.	COD.	MAT.	AF mm	L (mm)	Pt	g
35000		35001		6				35084		35085		6			
35002		35003		7				35086		35087		7			
35004		35005		8				35088		35089		8			
35006		35007		9				35090		35091		9			
35008		35009		10				35092		35093		10			
35010		35011		11				35094		35095		11			
35012		35013		12			190	35096		35097		12			190
74284		74285		13				35098		35099		13			
35014		35015		14				35100		35101		14			
35016		35017		15				35102		35103		15			
74294		74295		16				35104		35105		16			
74286		74287		17				35106		35107		17			
35018		35019		18			195	35108		35109		18			195
74288		74289		19			200	35110		35111		19			200
35020	Cu-Be	35021	Al-Bron	20	82	6	230	35112	Cu-Be	35113	Al-Bron	20	82	12	230
35022		35023		21			240	35114		35115		21			240
35024		35025		22			260	35116		35117		22			260
35026		35027		23			280	35118		35119		23			280
74290		74291		24			300	35120		35121		24			300
35028		35029		25			320	35122		35123		25			320
35030		35031		26			340	35124		35125		26			340
74292		74293		27			360	35126		35127		27			360
35032		35033		28			390	35128		35129		28			390
35034		35035		29			410	35130		35131		29			410
35036		35037		30			430	35132		35133		30			430
35038		35039		32			500	35134		35135		32			500
35040		35041		34			550	35136		35137		34			550
35042		35043		36			650	35138		35139		36			650
36450		36451		41			980	36454		36455		41			980

**Cu-Be** Cobre berilio / Beryllium copper / Cuivre beryllium / Kupfer beryllium / Koper beryllium / Rame-berillio / Сплав Медь Бериллий  
**Al-Bron** Aluminio bronce / Aluminium bronze / Alliage aluminium-bronze / Alliage aluminium-bronze / Aluminium brons / Aluminio bronzo / Сплав Алюминий Бронза

Si no encuentra el artículo que necesita, consúltenos en [info@egamaster.com](mailto:info@egamaster.com) o en [www.egamaster.com](http://www.egamaster.com)  
 If you can't find the item you look for, please ask us in [info@egamaster.com](mailto:info@egamaster.com) or in [www.egamaster.com](http://www.egamaster.com)  
 Si vous ne trouvez pas l'article que vous desirez, consultez-nous a [info@egamaster.com](mailto:info@egamaster.com) ou a [www.egamaster.com](http://www.egamaster.com)

05

ANTICHISPA  
NON-SPARKING  
ANTIDÉFLAGRANT  
FUNKENFREI  
ANTISCINTILLA  
ANTI-DEFLAGRANTE  
ИСКРОБЕЗОПАСНЫЙ



1/2"

■ SERIE LARGA / LONG SOCKETS / SÉRIE LONGUE / LANGE SERIE / SERIE LUNGA / SERIE LONGA / ВЫСОКАЯ СЕРИЯ

■ INCH

■ 6 PT.

■ 12 PT.



COD.	MAT.	COD.	MAT.	AF inch	L (mm)	Pt	g	COD.	MAT.	COD.	MAT.	AF inch	L (mm)	Pt	g
35044		35045		1/4				35140		35141		1/4			
35046		35047		5/16				35142		35143		5/16			
35048		35049		3/8				35144		35145		3/8			
35050		35051		7/16				35146		35147		7/16			
35052		35053		1/2		190		35148		35149		1/2		190	
35054		35055		9/16				35150		35151		9/16			
35056		35057		19/32				35152		35153		19/32			
35058		35059		5/8				35154		35155		5/8			
35060		35061		11/16				35156		35157		11/16			
35062		35063		3/4		200		35158		35159		3/4		200	
35064	Cu-Be	35065	Al-Bron	25/32	82	6	230	35160	Cu-Be	35161	Al-Bron	25/32	82	12	230
35066		35067		13/16			240	35162		35163		13/16			240
35068		35069		7/8			260	35164		35165		7/8			260
35070		35071		15/16			300	35166		35167		15/16			300
35072		35073		1			320	35168		35169		1			320
35074		35075		1.1/16			360	35170		35171		1.1/16			360
35076		35077		1.1/8			410	35172		35173		1.1/8			410
35078		35079		1.3/16			430	35174		35175		1.3/16			430
35080		35081		1.1/4			500	35176		35177		1.1/4			500
35082		35083		1.7/16			650	35178		35179		1.7/16			650
36444		36445		1.1/2			800	36448		36449		1.1/2			800

LLAVE DE CARRACA REVERSIBLE / REVERSIBLE RATCHET HANDLE / CLÉ À CLIQUET RÉVERSIBLE / UMSCHALTKNARRE / CHIAVE A CRICCO REVERSIBILE / ROQUETE REVERSIVEL / РЕВЕРСИВНАЯ ТРЕЩЕТКА

COD.	MAT.	COD.	MAT.	AF inch	L (mm)	g
70375	Cu-Be	71272	Al-Bron	1/2	250	600



CARRACA MACHO-HEMBRA / MALE-FEMALE RATCHET / CLIQUET MALE-FEMELLE / RATSCHKE DOPPELT FUNKTION / CRICCO MASCHIO-FEMMINA / ROQUETE MACHO-FÊMEA / ТРЕЩЕТКА ПАПА-МАМА

COD.	MAT.	COD.	MAT.	AF inch	L (mm)	g
73724	Cu-Be	73725	Al-Bron	1/2	250	450



MANGO CORREDIZO EN "T" / SLIDING "T" HANDLE / POIGNÉE COULISSANTE / T-GLEITGRIF / ASTA CON QUADRO SCORREVOLE "T" / CABO "T" CORREDIÇO / Т-ОБРАЗНАЯ С ПЛАВАЮЩЕЙ РУЧКОЙ

COD.	MAT.	COD.	MAT.	AF inch	L (inch)	g
70378		71274		1/2	10	400
70379	Cu-Be	71275	Al-Bron		12	500



Cu-Be Cobre berillo / Beryllium copper / Cuivre beryllium / Kupfer beryllium / Koper beryllium / Rame-berillio / Сплав Медь Бериллий  
Al-Bron Aluminio bronze / Aluminium bronze / Alliage aluminium-bronze / Alliage aluminium-bronze / Aluminium brons / Aluminio bronzo / Сплав Алюминий Бронза

1/2"

**MANGO ARTICULADO / SWIVEL HANDLE / MANCHE ARTICULÉ / GELENKGRIF / MANICO ARTICOLATO / CABO ARTICULADO / ГИБКАЯ РУКОЯТКА**

COD.	MAT.	COD.	MAT.	AF inch	L (mm)	g
72400		72401		1/2	230	330
72402	Cu-Be	72403	Al-Bron		330	400
72404		72405			410	550



**MANGO ACODADO / OFFSET HANDLE / MANCHE CONTRE COUDÉ / GEKRÖPFTE HANDGRIF / DOPPIO MANICO / CABO DESALINHADO / ИЗОГНУТАЯ РУКОЯТКА**

COD.	MAT.	COD.	MAT.	AF inch	L (mm)	g
72410	Cu-Be	72411	Al-Bron	1/2	230	400



**PUNTA PLANA CON VASO / FLAT BIT SOCKET / EMBOUT FENTE À DOUILLE / FLACHE SCHRAUBENDREHEREINSATZ / PUNTA PIATTA CON BUSSOLA / PONTA DE FENDA COM CHAVE DE CAIXA / ГОЛОВКА С ПЛОСКОЙ ОТВЕРТКОЙ**

COD.	MAT.	COD.	MAT.	AF inch	L (mm)	mm	g
73709	Cu-Be	73710	Al-Bron	1/2	50	13 x 2	100



**BERBIQUÍ / SPEEDER HANDLE / VILEBREQUIN / WINDE / LEVA GIROBECCHINO / MANIVELA / КОЛЕНЧАТАЯ РУЧКА**

COD.	MAT.	COD.	MAT.	AF inch	L (mm)	g
72416	Cu-Be	72417	Al-Bron	1/2	390	750



**ALARGADERA / EXTENSION / RALLONGE / VERLÄNGERUNG / PROLUNGA / EXTENÇÃO / УДЛИНИТЕЛЬ**

COD.	MAT.	COD.	MAT.	AF inch	L (inch)	g
70383		71279		1/2	4	200
76490		76491			5	245
70384	Cu-Be	71280	Al-Bron		8	400
70385		71281			10	500
75477		75478			16	715



**ARTICULACIÓN UNIVERSAL / UNIVERSAL JOINT / CARDAN UNIVERSEL / KARDANGELNENK / SNODO CARDANICO / CARDAN UNIVERSAL / КАРДАННОЕ СОЕДИНЕНИЕ**

COD.	MAT.	COD.	MAT.	AF inch	L (mm)	g
70372	Cu-Be	71269	Al-Bron	1/2	80	200



**ADAPTADOR / ADAPTER / ADAPTATEUR / VERBINDUNGSTEILE / ADATTATORE / PEÇA DE CONEXÃO / АДАПТЕР**

COD.	MAT.	COD.	MAT.	AF inch	AF inch	g
75720		75721		1/2-3/8	1/2-3/4	70
70369	Cu-Be	71266	Al-Bron			200



# 05

**ANTICHISPA  
NON-SPARKING  
ANTIDÉFLAGRANT  
FUNKENFREI  
ANTISCINTILLA  
ANTI-DEFLAGRANTE  
ИСКРБЕЗОПАСНЫЙ**



- 3/4"
- STANDARD
- MM
- 6 PT.

- 12 PT.



COD.	MAT.	COD.	MAT.	AF mm	L (mm)	Pt	g
74649		74653		17	50		200
75724		75725		18			
74650		74654		19			
74651		74655		21			
74652		74656		22			
70345		71220		24			
71908		72953		26	55	280	
70346		71221		27			
75726		75727		28			
75728		75729		29		320	
70347		71222		30			
75730		75731		31			
70348		71223		32	60	410	
77792	Cu-Be	77793	Al-Bron	33			
74863		74864		34			
77794		77795		35	65	700	
70349		71224		36			
77796		77797		37			
74865		74866		38	70	900	
70350		71225		41			
77798		77799		42			
70351		71226		46	70	950	
77800		77801		47			
70352		71227		50			
77802		77803		52	1100		
77804		77805		55			
77806		77807		60			

COD.	MAT.	COD.	MAT.	AF mm	L (mm)	Pt	g
75734		75735		17	50		200
75736		75737		18			
75738		75739		19			
75740		75741		21			
75742		75743		22			
74538		74547		24			
74539		74548		26	55	280	
74540		74549		27			
75744		75745		28			
75746		75747		29		320	
74541		74550		30			
75748		75749		31			
74542		74551		32	60	410	
77810	Cu-Be	77811	Al-Bron	33			
75750		75751		34			
77812		77813		35	65	700	
74543		74552		36			
77814		77815		37			
75752		75753		38	70	900	
74544		74553		41			
77816		77817		42			
74545		74554		46	70	950	
77818		77819		47			
74546		74555		50			
77820		77821		52	1100		
77822		77823		55			
77824		77825		60			

**Cu-Be** Cobre berilio / Beryllium copper / Cuivre beryllium / Kupfer beryllium / Koper beryllium / Rame-berillio / Сплав Медь Бериллий  
**Al-Bron** Aluminio bronce / Aluminium bronze / Alliage aluminium-bronze / Alliage aluminium-bronze / Aluminium brons / Aluminio bronzo / Сплав Аллюминий Бронза

# 05

**ANTICHISPA  
NON-SPARKING  
ANTIDÉFLAGRANT  
FUNKENFREI  
ANTISCINTILLA  
ANTI-DEFLAGRANTE  
ИСКРБЕЗОПАСНЫЙ**



3/4"

■ INCH

■ 6 PT.



■ 12 PT.



COD.	MAT.	COD.	MAT.	AP inch	L (mm)	Pt	g
74786		74787		3/4	50		220
75732		75733		13/16			240
74788		74789		7/8			
74790		74791		15/16	55		
74792		74793		1		280	
74802		74803		1.1/16			
74804		74805		1.1/8		310	
35846		35847		1.5/32			360
74867		74868		1.3/16			
35848		35849		1.7/32		400	
74869		74870		1.1/4			
71228	Cu-Be	71239	Al-Bron	1.5/16	60	6	430
71229		71240		1.3/8			470
71230		71241		1.7/16			480
71231		71242		1.1/2			550
71232		71243		1.9/16			650
71233		71244		1.5/8			
71234		71245		1.11/16			
71235		71246		1.3/4	65	700	
71236		71247		1.13/16			
71237		71248		1.7/8			
77808		77809		1.15/16		800	
71238		71249		2	70	850	

COD.	MAT.	COD.	MAT.	AP inch	L (mm)	Pt	g
75754		75755		3/4	50		220
75752		75753		13/16			240
75758		75759		7/8			
75760		75761		15/16	55		
75762		75763		1		280	
75764		75765		1.1/16			
75766		75767		1.1/8		310	
35856		35857		1.5/32			360
75768		75769		1.3/16			
35858		35859		1.7/32		400	
75770		75771		1.1/4			
74556	Cu-Be	74567	Al-Bron	1.5/16	60	12	430
74557		74568		1.3/8			470
74558		74569		1.7/16			480
74559		74570		1.1/2			550
74560		74571		1.9/16			650
74561		74572		1.5/8			
74562		74573		1.11/16			
74563		74574		1.3/4	65	700	
74564		74575		1.13/16			
74565		74576		1.7/8			
77826		77827		1.15/16		800	
74566		74577		2	70	850	

# BE SAFE...BE EFFICIENT

**Cu-Be** Cobre berilio / Beryllium copper / Cuivre beryllium / Kupfer beryllium / Koper beryllium / Rame-berillio / Сплав Медь Бериллий  
**Al-Bron** Aluminio bronce / Aluminium bronze / Alliage aluminium-bronze / Alliage aluminium-bronze / Aluminium brons / Aluminio bronzo / Сплав Аллюминий Бронза

Si no encuentra el artículo que necesita, consúltenos en [info@egamaster.com](mailto:info@egamaster.com) o en [www.egamaster.com](http://www.egamaster.com)  
 If you can't find the item you look for, please ask us in [info@egamaster.com](mailto:info@egamaster.com) or in [www.egamaster.com](http://www.egamaster.com)  
 Si vous ne trouvez pas l'article que vous desirez, consultez-nous a [info@egamaster.com](mailto:info@egamaster.com) ou a [www.egamaster.com](http://www.egamaster.com)



05

ANTICHISPA  
NON-SPARKING  
ANTIDÉFLAGRANT  
FUNKENFREI  
ANTISCINTILLA  
ANTI-DEFLAGRANTE  
ИСКРОБЕЗОПАСНЫЙ



3/4"

■ SERIE LARGA / LONG SOCKETS / SÉRIE LONGUE / LANGE SERIE / SERIE LUNGA / SERIE LONGA / ВЫСОКАЯ СЕРИЯ

■ MM

■ 6 PT.

■ 12 PT.



COD.	MAT.	COD.	MAT.	AF mm	L (mm)	Pt	g
35180		35181		17			
35182		35183		18			
35184		35185		19		500	
35186		35187		21			
35188		35189		22			
35190		35191		24		550	
35192		35193		26			
35194		35195		27			
35196		35197		28		600	
35198		35199		29			
35200		35201		30	90		
35202		35203		31			
35204		70484		32			
35206	Cu-Be	35207	Al-Bron	33		6	650
35208		35209		34			
35210		35211		35			
76775		70485		36		700	
35212		35213		37		750	
35214		35215		38		800	
35216		35217		41		900	
35218		35219		42		950	
35220		35221		46		1150	
35222		35223		47		1200	
35224		35225		50	100	1250	
35226		35227		52			
35228		35229		55		1300	
35230		35231		60		1400	

COD.	MAT.	COD.	MAT.	AF mm	L (mm)	Pt	g
35274		35275		17			
35276		35277		18			
35278		35279		19		500	
35280		35281		21			
35282		35283		22			
35284		35285		24		550	
35286		35287		26			
35288		35289		27			
35290		35291		28		600	
35292		35293		29			
35294		35295		30	90		
35296		35297		31			
35298		35299		32			
35300	Cu-Be	35301	Al-Bron	33		12	650
35302		35303		34			
35304		35305		35			
35306		35307		36		700	
35308		35309		37		750	
35310		35311		38		800	
35312		35313		41		900	
35314		35315		42		950	
35316		35317		46		1150	
35318		35319		47		1200	
35320		35321		50	100	1250	
35322		35323		52			
35324		35325		55		1300	
35326		35327		60		1400	

**Cu-Be** Cobre berilio / Beryllium copper / Cuivre beryllium / Kupfer beryllium / Koper beryllium / Rame-berillio / Сплав Медь Бериллий  
**Al-Bron** Aluminio bronce / Aluminium bronze / Alliage aluminium-bronze / Alliage aluminium-bronze / Aluminium brons / Aluminio bronzo / Сплав Аллюминий Бронза

# 05

**ANTICHISPA  
NON-SPARKING  
ANTIDÉFLAGRANT  
FUNKENFREI  
ANTISCINTILLA  
ANTI-DEFLAGRANTE  
ИСКРБЕЗОПАСНЫЙ**



3/4"

■ INCH

■ 6 PT.



■ 12 PT.



COD.	MAT.	COD.	MAT.	AF inch	L (mm)	Pt	g	COD.	MAT.	COD.	MAT.	AF inch	L (mm)	Pt	g
35232	Cu-Be	35233	Al-Bron	3/4	90	6	500	35328	Cu-Be	35329	Al-Bron	3/4	90	12	500
35234		13/16		35330				13/16							
35236		7/8		35332				7/8							
35238		15/16		35334				15/16							
35240		1		35336				1							
35242		1.1/16		35338				1.1/16							
35244		1.1/8		35340				1.1/8							
35246		1.3/16		35342				1.3/16							
35248		1.1/4		35344				1.1/4							
35250		1.5/16		35346				1.5/16							
35252		1.3/8		35348	1.3/8										
35254		1.7/16		35350	1.7/16										
35256		1.1/2		35352	1.1/2										
35258		1.9/16		35354	1.9/16										
35260		1.5/8		35356	1.5/8										
35262		1.11/16		35358	1.11/16										
35264		1.3/4		35360	1.3/4										
35266		1.13/16		35362	1.13/16										
35268		1.7/8		35364	1.7/8										
35270		1.15/16		35366	1.15/16										
35272	2	35368	2												

**CARRACA MACHO-HEMBRA / MALE-FEMALE RATCHET / CLIQUET MALE-FEMELLE / RATSCHÉ DOPPELT FUNKTION / CRICCO MASCHIO-FEMMINA / ROQUETE MACHO-FÊMEA / ТРЕЩЕТКА ПАПА-МАМА**

COD.	MAT.	COD.	MAT.	AF inch	L (mm)	g
73726	Cu-Be	73727	Al-Bron	3/4	300	1000



**LLAVE DE CARRACA REVERSIBLE / REVERSIBLE RATCHET HANDLE / CLÉ À CLIQUET RÉVERSIBLE / UMSCHALTKNARRE / CHIAVE A CRICCO REVERSIBILE / ROQUETE REVERSIVEL / РЕВЕРСИВНАЯ ТРЕЩЕТКА**

COD.	MAT.	COD.	MAT.	AF inch	L (mm)	g
70376	Cu-Be	71273	Al-Bron	3/4	390	1400



**CABEZA DE CARRACA / RATCHET HEAD / TÊTE À CLIQUET / RATSCHÉ KOPF / TESTA A CRICCO / CABEÇA DE ROQUETE / ГОЛОВКА ТРЕЩЕТКИ**

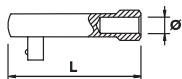

COD.	MAT.	COD.	MAT.	AF inch	L (mm)	O.D. mm	g
73712	Cu-Be	73713	Al-Bron	3/4	160	21	1500





**Cu-Be** Cobre berilio / Beryllium copper / Cuivre beryllium / Kupfer beryllium / Koper beryllium / Rame-berillio / Сплав Медь Бериллий  
**Al-Bron** Aluminio bronze / Aluminium bronze / Alliage aluminium-bronze / Alliage aluminium-bronze / Aluminium brons / Aluminio bronzo / Сплав Алюминий Бронза

Si no encuentra el artículo que necesita, consúltenos en [info@egamaster.com](mailto:info@egamaster.com) o en [www.egamaster.com](http://www.egamaster.com)  
 If you can't find the item you look for, please ask us in [info@egamaster.com](mailto:info@egamaster.com) or in [www.egamaster.com](http://www.egamaster.com)  
 Si vous ne trouvez pas l'article que vous desirez, consultez-nous a [info@egamaster.com](mailto:info@egamaster.com) ou a [www.egamaster.com](http://www.egamaster.com)





3/4"



**MANGO CORREDIZO EN "T" / SLIDING "T" HANDLE / POIGNÉE COULISSANTE / T-GLEITGRIF / ASTA CON QUADRO SCORREVOLE "T" / CABO "T" CORREDIÇO / Т-ОБРАЗНАЯ С ПЛАВАЮЩЕЙ РУЧКОЙ**

COD.	MAT.	COD.	MAT.		L (mm)	
70380	Cu-Be	71276	Al-Bron	3/4	250	900
70381		71277			460	1700



**MANGO CORREDIZO EN "T" LARGO / LONG SLIDING "T" HANDLE / POIGNÉE COULISSANTE LONGUE / LANGE T-GRIFF MIT GLEITSTÜCK / MANICO LUNGO SCORREVOLE A T / CABO T CORREDIÇO LONGO / Т-ОБРАЗНАЯ С ПЛАВАЮЩЕЙ РУЧКОЙ ДЛИННАЯ**

COD.	MAT.	COD.	MAT.		L (mm)	H (mm)	
73717	Cu-Be	73718	Al-Bron	3/4	350	190	1500



**MANGO ARTICULADO / SWIVEL HANDLE / MANCHE ARTICULÉ / GELENKGRIF / MANICO ARTICOLATO / CABO ARTICULADO / ГИБКАЯ РУКОЯТКА**

COD.	MAT.	COD.	MAT.		L (mm)	
72406	Cu-Be	72407	Al-Bron	3/4	300	600



**MANGO ACODADO / OFFSET HANDLE / MANCHE CONTRE COUDÉ / GEKRÖPFTE HANDGRIFF / DOPPIO MANICO / CABO DESALINHADO / ИЗГНУТАЯ РУКОЯТКА**

COD.	MAT.	COD.	MAT.		L (mm)	
72412	Cu-Be	72413	Al-Bron	3/4	280	700



**ALARGADERA / EXTENSION / RALLONGE / VERLÄNGERUNG / PROLUNGA / EXTENÇÃO / УДЛИНИТЕЛЬ**

COD.	MAT.	COD.	MAT.		L (inch)	
70386	Cu-Be	71282	Al-Bron	3/4	4	200
70387		71283			8	400
70388		71284			10	500
75487		75488			16	1590





**ARTICULACIÓN UNIVERSAL / UNIVERSAL JOINT / CARDAN UNIVERSEL / KARDANGELLENK / SNODO CARDANICO / CARDAN UNIVERSAL / КАРДАННОЕ СОЕДИНЕНИЕ**

COD.	MAT.	COD.	MAT.		L (mm)	
70373	Cu-Be	71270	Al-Bron	3/4	135	600

**ARTICULACIÓN FLEXIBLE / FLEXIBLE JOINT / ARTICULATION FLEXIBLE / FLEXIBLE VERBINDUNG / ARTICOLAZIONE FLESSIBILE / ARTICULAÇÃO FLEXÍVEL / ГИБКОЕ СОЕДИНЕНИЕ**

COD.	MAT.	COD.	MAT.		L (mm)		
72396	Cu-Be	72397	Al-Bron	3/4	120	21	800

**ADAPTADOR / ADAPTER / ADAPTATEUR / VERBINDUNGSTEILE / ADATTATORE / PEÇA DE CONEXÃO / АДАПТЕР**

COD.	MAT.	COD.	MAT.			
70368	Cu-Be	71265	Al-Bron	3/4-1/2		200
70371		71268		3/4-1		410





# 05

**ANTICHISPA  
NON-SPARKING  
ANTIDÉFLAGRANT  
FUNKENFREI  
ANTISCINTILLA  
ANTI-DEFLAGRANTE  
ИСКРБЕЗОПАСНЫЙ**



- 1"
- STANDARD
- MM
- 6 PT.

- 12 PT.



COD.	MAT.	COD.	MAT.	AF mm	L (mm)	Pt	g
75772		75773		22			330
75774		75775		24			340
75776		75777		25			350
75778		75779		26	55		360
75780		75781		27			370
75782		75783		28			380
75784		75785		29			400
75786		75787		30			410
75788		75789		31			440
75790		75791		32	60		450
75792		75793		34			460
75794		75795		36			500
75796		75797		38			600
70353	Cu-Be	71250	Al-Bron	41		6	700
70354		71251		42	65		800
70355		71252		46			1000
70356		71253		50	70		1100
70357		71254		55	75		1400
70358		71255		60			1500
70359		71256		65	80		2000
70360		71257		70			2200
70361		71258		75			4600
70362		71259		80	85		4800
70363		71260		85			4900
70364		71261		90			5000
70365		71262		95	90		5200
70366		71263		100			
70367		71264		105	95		

COD.	MAT.	COD.	MAT.	AF mm	L (mm)	Pt	g
75828		75829		22			330
75830		75831		24			340
75832		75833		25			350
75834		75835		26	55		360
75836		75837		27			370
75838		75839		28			400
75840		75841		29			410
75842		75843		30			440
75844		75845		31			450
75846		75847		32	60		460
75848		75849		34			500
75850		75851		36			600
75852		75853		38			700
74578	Cu-Be	74593	Al-Bron	41		12	800
74579		74594		42	65		1000
74580		74595		46			1100
74581		74596		50	70		1400
74582		74597		55	75		1500
74583		74598		60			2000
74584		74599		65	80		2200
74585		74600		70			4600
74586		74601		75			4800
74587		74602		80	85		4900
74588		74603		85			5000
74589		74604		90			5200
74590		74605		95	90		
74591		74606		100			
74592		74607		105	95		

**Cu-Be** Cobre berilio / Beryllium copper / Cuivre beryllium / Kupfer beryllium / Koper beryllium / Rame-berillio / Сплав Медь Бериллий  
**Al-Bron** Aluminio bronce / Aluminium bronze / Alliage aluminium-bronze / Alliage aluminium-bronze / Aluminium brons / Aluminio bronzo / Сплав Алюминий Бронза

Si no encuentra el artículo que necesita, consúltenos en [info@egamaster.com](mailto:info@egamaster.com) o en [www.egamaster.com](http://www.egamaster.com)  
 If you can't find the item you look for, please ask us in [info@egamaster.com](mailto:info@egamaster.com) or in [www.egamaster.com](http://www.egamaster.com)  
 Si vous ne trouvez pas l'article que vous desirez, consultez-nous a [info@egamaster.com](mailto:info@egamaster.com) ou a [www.egamaster.com](http://www.egamaster.com)



05

ANTICHISPA  
NON-SPARKING  
ANTIDÉFLAGRANT  
FUNKENFREI  
ANTISCINTILLA  
ANTI-DEFLAGRANTE  
ИСКРБЕЗОПАСНЫЙ



1"

■ STANDARD

■ INCH

■ 6 PT.

■ 12 PT.



COD.	MAT.	COD.	MAT.	AP inch	L (mm)	Pt	g
75798		75799		1.1/16	55	6	360
75800		75801		1.1/8			
75802		75803		1.3/16	60	6	400
75804		75805		1.1/4			
75806		75807		1.5/16	65	6	440
75808		75809		1.3/8			
75810		75811		1.7/16	70	6	460
75812		75813		1.1/2			
75814		75815		1.5/8	75	6	500
77828		77829		1.13/16			
75816	Cu-Be	75817	Al-Bron	1.7/8	80	6	700
75818		75819		2			
77830		77831		2.1/8	85	6	800
75820		75821		2.1/4			
77832		77833		2.3/8	90	6	850
75822		75823		2.1/2			
77834		77835		2.9/16	100	6	1000
75824		75825		2.3/4			
77836		77837		2.15/16	1250	6	1250
75826		75827		3			
77838		77839		3.1/8	1400	6	1400
					1500	6	1500
					2300	6	2300

COD.	MAT.	COD.	MAT.	AP inch	L (mm)	Pt	g
75854		75855		1.1/16	55	12	360
75856		75857		1.1/8			
75858		75859		1.3/16	60	12	400
75860		75861		1.1/4			
75862		75863		1.5/16	65	12	440
75864		75865		1.3/8			
75866		75867		1.7/16	70	12	460
75868		75869		1.1/2			
75870		75871		1.5/8	75	12	500
77840		77841		1.13/16			
75872	Cu-Be	75873	Al-Bron	1.7/8	80	12	700
75874		75875		2			
77842		77843		2.1/8	85	12	800
75876		75877		2.1/4			
77844		77845		2.3/8	90	12	850
75878		75879		2.1/2			
77846		77847		2.9/16	100	12	1000
75880		75881		2.3/4			
77848		77849		2.15/16	1250	12	1250
75882		75883		3			
77850		77851		3.1/8	1400	12	1400
					1500	12	1500
					2300	12	2300

# EGGA Master

## ART IN INNOVATION

**Cu-Be** Cobre berilio / Beryllium copper / Cuivre beryllium / Kupfer beryllium / Koper beryllium / Rame-berillio / Сплав Медь Бериллий  
**Al-Bron** Aluminio bronze / Aluminium bronze / Alliage aluminium-bronze / Alliage aluminium-bronze / Aluminium brons / Aluminio bronzo / Сплав Аллюминий Бронза

05

**ANTICHISPA**  
**NON-SPARKING**  
**ANTIDÉFLAGRANT**  
**FUNKENFREI**  
**ANTISCINTILLA**  
**ANTI-DEFLAGRANTE**  
**ИСКРБЕЗОПАСНЫЙ**



1"

■ **SERIE LARGA / LONG SOCKETS / SÉRIE LONGUE / LANGE SERIE / SERIE LUNGA / SERIE LONGA / ВЫСОКАЯ СЕРИЯ**■ **MM**■ **6 PT.**■ **12 PT.**

COD.	MAT.	COD.	MAT.	AF mm	L (mm)	Pt	g	COD.	MAT.	COD.	MAT.	AF mm	L (mm)	Pt	g
35370		35371		22				35468		35469		22			
35372		35373		24				35470		35471		24			
35374		35375		25				35472		35473		25			
35376		35377		26				35474		35475		26			
35378		35379		27				35476		35477		27			
35380		35381		28		800		35478		35479		28		800	
35382		35383		29				35480		35481		29			
35384		35385		30	100			35482		35483		30	100		
35386		35387		31				35484		35485		31			
35388		35389		32				35486		35487		32			
35390		35391		34		850		35488		35489		34		850	
35392		35393		36		900		35490		35491		36		900	
35394		35395		38		950		35492		35493		38		950	
35396		35397		41		1000		35494		35495		41		1000	
35398	Cu-Be	35399	Al-Bron	42		1050	6	35496	Cu-Be	35497	Al-Bron	42		1050	12
35400		35401		46		1250		35498		35499		46		1250	
35402		35403		50	115	1450		35500		35501		50	115	1450	
35404		35405		55	125	1750		35502		35503		55	125	1750	
35406		35407		60		2100		35504		35505		60		2100	
35408		35409		65	135	2600		35506		35507		65	135	2600	
35410		35411		70		3050		35508		35509		70		3050	
35412		35413		75		3850		35510		35511		75		3850	
35414		35415		80		4300		35512		35513		80		4300	
35416		35417		85		4600		35514		35515		85		4600	
35418		35419		90	140	4900		35516		35517		90	140	4900	
35420		35421		95		5300		35518		35519		95		5300	
35422		35423		100		5750		35520		35521		100		5750	
35424		35425		105		6200		35522		35523		105		6200	

**Cu-Be** Cobre berilio / Beryllium copper / Cuivre beryllium / Kupfer beryllium / Koper beryllium / Rame-berillio / Сплав Медь Бериллий  
**Al-Bron** Aluminio bronce / Aluminium bronze / Alliage aluminium-bronze / Alliage aluminium-bronze / Aluminium brons / Aluminio bronzo / Сплав Алюминий Бронза

Si no encuentra el artículo que necesita, consúltenos en [info@egamaster.com](mailto:info@egamaster.com) o en [www.egamaster.com](http://www.egamaster.com)  
 If you can't find the item you look for, please ask us in [info@egamaster.com](mailto:info@egamaster.com) or in [www.egamaster.com](http://www.egamaster.com)  
 Si vous ne trouvez pas l'article que vous desirez, consultez-nous a [info@egamaster.com](mailto:info@egamaster.com) ou a [www.egamaster.com](http://www.egamaster.com)

# 05

**ANTICHISPA  
NON-SPARKING  
ANTIDÉFLAGRANT  
FUNKENFREI  
ANTISCINTILLA  
ANTI-DEFLAGRANTE  
ИСКРОБЕЗОПАСНЫЙ**



1"

■ **SERIE LARGA / LONG SOCKETS / SÉRIE LONGUE / LANGE SERIE / SERIE LUNGA / SERIE LONGA / ВЫСОКАЯ СЕРИЯ**

■ **INCH**

■ **6 PT.**

■ **12 PT.**



COD.	MAT.	COD.	MAT.	AF inch	L (mm)	Pt	g	COD.	MAT.	COD.	MAT.	AF inch	L (mm)	Pt	g
35426		35427		1.1/16				35524		35525		1.1/16			
35428		35429		1.1/8		800		35526		35527		1.1/8		800	
35430		35431		1.3/16				35528		35529		1.3/16			
35432		35433		1.1/4				35530		35531		1.1/4			
35434		35435		1.5/16	100	850		35532		35533		1.5/16	100	850	
35436		35437		1.3/8				35534		35535		1.3/8			
35438		35439		1.7/16		900		35536		35537		1.7/16		900	
35440		35441		1.1/2		950		35538		35539		1.1/2		950	
35442		35443		1.5/8		1000		35540		35541		1.5/8		1000	
35444		35445		1.13/16		1250		35542		35543		1.13/16		1250	
35446	Cu-Be	35447	Al-Bron	1.7/8	115	6	1300	35544	Cu-Be	35545	Al-Bron	1.7/8	115	12	1300
35448		35449		2		1450		35546		35547		2		1450	
35450		35451		2.1/8		1650		35548		35549		2.1/8		1650	
35452		35453		2.1/4	125	1800		35550		35551		2.1/4	125	1800	
35454		35455		2.3/8		2100		35552		35553		2.3/8		2100	
35456		35457		2.1/2		2300		35554		35555		2.1/2		2300	
35458		35459		2.9/16	135	2600		35556		35557		2.9/16	135	2600	
35460		35461		2.3/4		3050		35558		35559		2.3/4		3050	
35462		35463		2.15/16		3850		35560		35561		2.15/16		3850	
35464		35465		3	140	4000		35562		35563		3	140	4000	
35466		35467		3.1/8		4300		35564		35565		3.1/8		4300	

■ **LLAVE DE CARRACA REVERSIBLE / REVERSIBLE RATCHET HANDLE / CLÉ À CLIQUET RÉVERSIBLE / UMSCHALTKNARRE / CHIAVE A CRICCO REVERSIBILE / ROQUETE REVERSIVEL / РЕВЕРСИВНАЯ ТРЕЩЕТКА**

COD.	MAT.	COD.	MAT.	AF inch	L (mm)	g
72630	Cu-Be	72629	Al-Bron	1	550	1600



■ **CABEZA DE CARRACA / RATCHET HEAD / TÊTE À CLIQUET / RATSCHEN KOPF / TESTA A CRICCO / CABEÇA DE ROQUETE / ГОЛОВКА ТРЕЩЕТКИ**

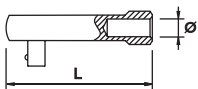

COD.	MAT.	COD.	MAT.	AF inch	L (mm)	O.D. mm	g
73714	Cu-Be	73715	Al-Bron	1	180	23	3000



■ **CARRACA MACHO-HEMBRA / MALE-FEMALE RATCHET / CLIQUET MALE-FEMELLE / RATSCHEN DOPPELT FUNKTION / CRICCO MASCHIO-FEMMINA / ROQUETE MACHO-FÊMEA / ТРЕЩЕТКА ПАПА-МАМА**



COD.	MAT.	COD.	MAT.	AF inch	L (mm)	g
73728	Cu-Be	73729	Al-Bron	1	300	1000



**Cu-Be** Cobre berilio / Beryllium copper / Cuivre beryllium / Kupfer beryllium / Koper beryllium / Rame-berillio / Сплав Медь Бериллий  
**Al-Bron** Aluminio bronze / Aluminium bronze / Alliage aluminium-bronze / Alliage aluminium-bronze / Aluminium brons / Aluminio bronzo / Сплав Алюминий Бронза



1"

**MANGO CORREDIZO EN "T" / SLIDING "T" HANDLE / POIGNÉE COULISSANTE / T-GLEITGRIF / ASTA CON QUADRO SCORREVOLE "T" / CABO "T" CORREDIÇO / Т-ОБРАЗНАЯ С ПЛАВАЮЩЕЙ РУЧКОЙ**

COD.	MAT.	COD.	MAT.		L (inch)	
70382	Cu-Be	71278	Al-Bron	1	12	2300



**MANGO CORREDIZO EN "T" LARGO / LONG SLIDING "T" HANDLE / POIGNÉE COULISSANTE LONGUE / LANGE T-GRIFF MIT GLEITSTÜCK / MANICO LUNGO SCORREVOLE A T / CABO T CORREDIÇO LONGO / Т-ОБРАЗНАЯ С ПЛАВАЮЩЕЙ РУЧКОЙ ДЛИННАЯ**

COD.	MAT.	COD.	MAT.		L (mm)	H (mm)	
73719	Cu-Be	73720	Al-Bron	1	400	190	2400





**ALARGADERA / EXTENSION / RALLONGE / VERLÄNGERUNG / PROLUNGA / EXTENÇÃO / УДЛИНИТЕЛЬ**

COD.	MAT.	COD.	MAT.		L (inch)	
70389	Cu-Be	71285	Al-Bron	1	4	400
70390	Cu-Be	71286	Al-Bron	1	10	800





**ADAPTADOR / ADAPTER / ADAPTATEUR / VERBINDUNGSTEILE / ADATTATORE / PEÇA DE CONEXÃO / АДАПТЕР**

COD.	MAT.	COD.	MAT.		L (inch)	
70370	Cu-Be	71267	Al-Bron	1-3/4		600





**ARTICULACIÓN UNIVERSAL / UNIVERSAL JOINT / CARDAN UNIVERSEL / KARDANGELNENK / SNODO CARDANICO / CARDAN UNIVERSAL / КАРДАННОЕ СОЕДИНЕНИЕ**

COD.	MAT.	COD.	MAT.		L (mm)	
70374	Cu-Be	71271	Al-Bron	1	145	1300





**ARTICULACIÓN FLEXIBLE / FLEXIBLE JOINT / ARTICULATION FLEXIBLE / FLEXIBLE VERBINDUNG / ARTICOLAZIONE FLESSIBILE / ARTICULAÇÃO FLEXÍVEL / ГИБКОЕ СОЕДИНЕНИЕ**

COD.	MAT.	COD.	MAT.		L (mm)		
72398	Cu-Be	72399	Al-Bron	1	120	21	1100





**MANGO ARTICULADO / SWIVEL HANDLE / MANCHE ARTICULÉ / GELENKGRIF / MANICO ARTICOLATO / CABO ARTICULADO / ГИБКАЯ РУКОЯТКА**

COD.	MAT.	COD.	MAT.		L (mm)	
72408	Cu-Be	72409	Al-Bron	1	315	850



**MANGO ACODADO / OFFSET HANDLE / MANCHE CONTRE COUDÉ / GEKRÖPFTE HANDGRIFF / DOPPIO MANICO / CABO DESALINHADO / ИЗОГНУТАЯ РУКОЯТКА**

COD.	MAT.	COD.	MAT.		L (mm)	
72414	Cu-Be	72415	Al-Bron	1	300	1100



**Cu-Be** Cobre berilio / Beryllium copper / Cuivre beryllium / Kupfer beryllium / Koper beryllium / Rame-berillio / Сплав Медь Бериллий  
**Al-Bron** Aluminio bronze / Aluminium bronze / Alliage aluminium-bronze / Alliage aluminium-bronze / Aluminium brons / Aluminio bronzo / Сплав Алюминий Бронза

Si no encuentra el artículo que necesita, consúltenos en [info@egamaster.com](mailto:info@egamaster.com) o en [www.egamaster.com](http://www.egamaster.com)  
 If you can't find the item you look for, please ask us in [info@egamaster.com](mailto:info@egamaster.com) or in [www.egamaster.com](http://www.egamaster.com)  
 Si vous ne trouvez pas l'article que vous désirez, consultez-nous a [info@egamaster.com](mailto:info@egamaster.com) ou a [www.egamaster.com](http://www.egamaster.com)

## ■ SET

## ■ 1/2"

COD.	MAT.	AF inch	PCS.	COD. PCS.	AF mm	AF inch	Kg
<b>74263</b>	Cu-Be	1/2	9	74452, 74453, 74454, 74456, 74459, 74461, 74464, 74466	10-11-12-14-17-19-22-24	-	1,4
<b>35810</b>				74504, 74505, 74506, 74509, 74510, 74511, 74514, 74515	-	3/8"-7/16"-1/2"-5/8"-11/16"-3/4" 7/8"-15/16"	

**ESPECIFICACIONES TÉCNICAS / TECHNICAL SPECIFICATION / DÉTAILS TECHNIQUES**

Mango acodado / Offset handle / Manche contre coudé 230 mm, 400 g (72410)

COD.	MAT.	AF inch	PCS.	COD. PCS.	AF mm	AF inch	Kg
<b>74264</b>	Al-Bron	1/2	9	74479, 74480, 74481, 74483, 74486, 74488, 74491, 74493	10-11-12-14-17-19-22-24	-	1,4
<b>35819</b>				74522, 74523, 74524, 74527, 74528, 74529, 74532, 74533	-	3/8"-7/16"-1/2"-5/8"-11/16"-3/4" 7/8"-15/16"	

**ESPECIFICACIONES TÉCNICAS / TECHNICAL SPECIFICATION / DÉTAILS TECHNIQUES**

Mango acodado / Offset handle / Manche contre coudé 230 mm, 400 g (72411)

COD.	MAT.	AF inch	PCS.	COD. PCS.	AF mm	AF inch	Kg
<b>74265</b>	Cu-Be	1/2	12	74450, 74452, 74453, 74454, 74456, 74459, 74461, 74464, 74466, 74469	8-10-11-12-14-17-19-22-24-27	-	2,3
<b>35811</b>				74503, 74504, 74505, 74506, 74509, 74510, 74511, 74514, 74515, 74517	-	5/16"-3/8"-7/16"-1/2"-5/8"- 11/16"-3/4"-7/8"-15/16"- 1.1/16"	

**ESPECIFICACIONES TÉCNICAS / TECHNICAL SPECIFICATION / DÉTAILS TECHNIQUES**

Mango articulado / Hinged handle / Manche articulé 230 mm, 330 g (72400)

Carraca / Ratchet / Cliquet 250 mm, 600 g (70375)

COD.	MAT.	AF inch	PCS.	COD. PCS.	AF mm	AF inch	Kg
<b>74266</b>	Al-Bron	1/2	12	74477, 74479, 74480, 74481, 74483, 74486, 74488, 74491, 74493, 74496	8-10-11-12-14-17-19-22-24-27	-	2,3
<b>35820</b>				74521, 74522, 74523, 74524, 74527, 74528, 74529, 74532, 74533, 74535	-	5/16"-3/8"-7/16"-1/2"-5/8"- 11/16"-3/4"-7/8"-15/16"- 1.1/16"	

**ESPECIFICACIONES TÉCNICAS / TECHNICAL SPECIFICATION / DÉTAILS TECHNIQUES**

Mango articulado / Hinged handle / Manche articulé 230 mm, 330 g (72401)

Carraca / Ratchet / Cliquet 250 mm, 600 g (71272)

COD.	MAT.	AF inch	PCS.	COD. PCS.	AF mm	AF inch	Kg
<b>74267</b>	Cu-Be	1/2	16	74452, 74453, 74454, 74456, 74459, 74461, 74464, 74466, 74469, 74472, 74473	10-11-12-14-17-19-22-24-27- 30-32	-	4,5
<b>35812</b>				74504, 74505, 74506, 74509, 74510, 74511, 74514, 74515, 74517, 77790, 74519	-	3/8"-7/16"-1/2"-5/8"-11/16"-3/4"- 7/8"-15/16"-1.1/16"-1.3/16"- 1.1/4"	

**ESPECIFICACIONES TÉCNICAS / TECHNICAL SPECIFICATION / DÉTAILS TECHNIQUES**

Alargadera / Extension / Rallonge 125-250 mm (70385)

Berbiquí / Speeder handle / Vilebrequin 390 mm (72416)

Mango corredizo en T / Sliding T handle / Poignée coulissante 250 mm (70378)

Carraca / Ratchet / Cliquet 250 mm (70375)



05

**ANTICHISPA  
NON-SPARKING  
ANTIDÉFLAGRANT  
FUNKENFREI  
ANTISCINTILLA  
ANTI-DEFLAGRANTE  
ИСКРОБЕЗОПАСНЫЙ**



1/2"

COD.	MAT.	AF $\frac{\downarrow}{\uparrow}$ inch	PCS.	COD. PCS.	AF $\frac{\downarrow}{\uparrow}$ mm	AF $\frac{\downarrow}{\uparrow}$ inch	Kg
<b>74268</b>				74479, 74480, 74481, 74483, 74486, 74488, 74491, 74493, 74496, 74499, 74500	10-11-12-14-17-19-22-24-27-30-32	-	
<b>35821</b>	Al-Bron	1/2	16	74522, 74523, 74524, 74527, 74528, 74529, 74532, 74533, 74535, 77791, 74537	-	3/8"-7/16"-1/2"-5/8"-11/16"-3/4"-7/8"-15/16"-1.1/16"-1.3/16"-1.1/4"	4,5

**ESPECIFICACIONES TÉCNICAS / TECHNICAL SPECIFICATION / DÉTAILS TECHNIQUES**

Alargadera / Extension / Rallonge	125-250 mm (71281)
Berbiquí / Speeder handle / Vilebrequin	390 mm (72417)
Mango corredizo en T / Sliding T handle / Poignée coulissante	250 mm (71274)
Carraca / Ratchet / Cliquet	250 mm (71272)

COD.	MAT.	AF $\frac{\downarrow}{\uparrow}$ inch	PCS.	COD. PCS.	AF $\frac{\downarrow}{\uparrow}$ mm	AF $\frac{\downarrow}{\uparrow}$ inch	Kg
<b>74269</b>				74452, 74453, 74454, 74455, 74456, 74457, 74458, 74459, 74460, 74461, 74462, 74463, 74464, 74465, 74466, 74469, 74472, 74473	10-11-12-13-14-15-16-17-18-19-20-21-22-23-24-27-30-32	-	
<b>35813</b>	Cu-Be	1/2	24	74502, 74503, 74504, 74505, 74506, 74507, 74508, 74509, 74510, 74511, 74512, 74513, 74514, 74515, 74516, 74517, 77790, 74519	-	1/4"-5/16"-3/8"-7/16"-1/2"-19/32"-5/8"-11/16"-9/16"-3/4"-25/32"-13/16"-7/8"-1"-15/16"-1.1/16"-1.3/16"-1.1/4"	5,5

**ESPECIFICACIONES TÉCNICAS / TECHNICAL SPECIFICATION / DÉTAILS TECHNIQUES**

Articulación universal / Universal Joint / Cardan Universel	80 mm (70372)
Alargadera / Extension / Rallonge	125-250 mm (70385)
Berbiquí / Speeder handle / Vilebrequin	390 mm (72416)
Mango corredizo en T / Sliding T handle / Poignée coulissante	250 mm (70378)
Carraca / Ratchet / Cliquet	250 mm (70375)



COD.	MAT.	AF $\frac{\downarrow}{\uparrow}$ inch	PCS.	COD. PCS.	AF $\frac{\downarrow}{\uparrow}$ mm	AF $\frac{\downarrow}{\uparrow}$ inch	Kg
<b>74270</b>				74479, 74480, 74481, 74482, 74483, 74484, 74485, 74486, 74487, 74488, 74489, 74490, 74491, 74492, 74493, 74496, 74499, 74500	10-11-12-13-14-15-16-17-18-19-20-21-22-23-24-27-30-32	-	
<b>35822</b>	Al-Bron	1/2	24	74520, 74521, 74522, 74523, 74524, 74525, 74526, 74527, 74528, 74529, 74530, 74531, 74532, 74533, 74534, 74535, 77791, 74537	-	1/4"-5/16"-3/8"-7/16"-1/2"-19/32"-5/8"-11/16"-9/16"-3/4"-25/32"-13/16"-7/8"-1"-15/16"-1.1/16"-1.3/16"-1.1/4"	5,5

**ESPECIFICACIONES TÉCNICAS / TECHNICAL SPECIFICATION / DÉTAILS TECHNIQUES**

Articulación universal / Universal Joint / Cardan Universel	80 mm (71269)
Alargadera / Extension / Rallonge	125-250 mm (71281)
Berbiquí / Speeder handle / Vilebrequin	390 mm (72417)
Mango corredizo en T / Sliding T handle / Poignée coulissante	250 mm (71274)
Carraca / Ratchet / Cliquet	250 mm (71272)

**Cu-Be** Cobre berilio / Beryllium copper / Cuivre beryllium / Kupfer beryllium / Koper beryllium / Rame-berillio / Сплав Медь Бериллий  
**Al-Bron** Aluminio bronce / Aluminium bronze / Alliage aluminium-bronze / Alliage aluminium-bronze / Aluminium brons / Aluminio bronzo / Сплав Алюминий Бронза

Si no encuentra el artículo que necesita, consúltenos en [info@egamaster.com](mailto:info@egamaster.com) o en [www.egamaster.com](http://www.egamaster.com)  
 If you can't find the item you look for, please ask us in [info@egamaster.com](mailto:info@egamaster.com) or in [www.egamaster.com](http://www.egamaster.com)  
 Si vous ne trouvez pas l'article que vous desirez, consultez-nous a [info@egamaster.com](mailto:info@egamaster.com) ou a [www.egamaster.com](http://www.egamaster.com)

**EGAMaster**  
ART IN INNOVATION

1/2"

COD.	MAT.	AF $\frac{1}{2}$ inch	PCS.	COD. PCS.	AF mm	AF inch	Kg
74271				74452, 74453, 74454, 74455, 74456, 74457, 74458, 74459, 74460, 74461, 74462, 74463, 74464, 74465, 74466, 74468, 74469, 74470, 74472, 74473	10-11-12-13-14-15-16-17-18-19-20-21-22-23-24-26-27-28-30-32	-	
35814	Cu-Be	1/2	27	74502, 74503, 74504, 74505, 74506, 74507, 74508, 74509, 74510, 74511, 74512, 74513, 74514, 35854, 74515, 74516, 74517, 74518, 77790, 74519	-	1/4"-5/16"-3/8"-7/16"-1/2"-19/32"-5/8"-11/16"-9/16"-3/4"-25/32"-13/16"-7/8"-29/32"-15/16"-1"-1.1/16"-1.1/8"-1.3/16"-1.1/4"	6,0

**ESPECIFICACIONES TÉCNICAS / TECHNICAL SPECIFICATION / DÉTAILS TECHNIQUES**

Punta plana con vaso / Flat bit socket / Embout fente à douille	13 x 2 mm (73709)
Articulación universal / Universal Joint / Cardan Universel	80 mm (70372)
Alargadera / Extension / Rallonge	125-250 mm (70385)
Berbiquí / Speeder handle / Vilebrequin	390 mm (72416)
Mango corredizo en T / Sliding T handle / Poignée coulissante	250 mm (70378)
Carraca / Ratchet / Cliquet	250 mm (70375)

COD.	MAT.	AF $\frac{1}{2}$ inch	PCS.	COD. PCS.	AF mm	AF inch	Kg
74272				74479, 74480, 74481, 74482, 74483, 74484, 74485, 74486, 74487, 74488, 74489, 74490, 74491, 74492, 74493, 74495, 74496, 74497, 74499, 74500	10-11-12-13-14-15-16-17-18-19-20-21-22-23-24-26-27-28-30-32	-	
35823	Al-Bron	1/2	27	74520, 74521, 74522, 74523, 74524, 74525, 74526, 74527, 74528, 74529, 74530, 74531, 74532, 35855, 74533, 74534, 74535, 74536, 77791, 74537	-	1/4"-5/16"-3/8"-7/16"-1/2"-19/32"-5/8"-11/16"-9/16"-3/4"-25/32"-13/16"-7/8"-29/32"-15/16"-1"-1.1/16"-1.1/8"-1.3/16"-1.1/4"	6,0

**ESPECIFICACIONES TÉCNICAS / TECHNICAL SPECIFICATION / DÉTAILS TECHNIQUES**

Punta plana con vaso / Flat bit socket / Embout fente à douille	13 x 2 mm (73710)
Articulación universal / Universal Joint / Cardan Universel	80 mm (71269)
Alargadera / Extension / Rallonge	125-250 mm (71281)
Berbiquí / Speeder handle / Vilebrequin	390 mm (72417)
Mango corredizo en T / Sliding T handle / Poignée coulissante	250 mm (71274)
Carraca / Ratchet / Cliquet	250 mm (71272)

COD.	MAT.	AF $\frac{1}{2}$ inch	PCS.	COD. PCS.	AF mm	AF inch	Kg
74273				74450, 74451, 74452, 74453, 74454, 74455, 74456, 74457, 74458, 74459, 74460, 74461, 74462, 74463, 74464, 74465, 74466, 74468, 74469, 74470, 74472, 74473	8-9-10-11-12-13-14-15-16-17-18-19-20-21-22-23-24-26-27-28-30-32	-	
35815	Cu-Be	1/2	31	74503, 35850, 74504, 74505, 74506, 74507, 74508, 74509, 74510, 35852, 74511, 74512, 74513, 74514, 35854, 74515, 74516, 74517, 74518, 77790, 74519	-	5/16"-11/32"-3/8"-7/16"-1/4"-1/2"-9/16"-19/32"-5/8"-11/16"-23/32"-3/4"-25/32"-13/16"-7/8"-29/32"-15/16"-1"-1.1/16"-1.1/8"-1.3/16"-1.1/4"	6,5

**ESPECIFICACIONES TÉCNICAS / TECHNICAL SPECIFICATION / DÉTAILS TECHNIQUES**

Vaso para bujías / Spark plug socket / Douille à bougie	13/16"
Punta plana con vaso / Flat bit socket / Embout fente à douille	13 x 2 mm (73709)
Mango acodado / Offset handle / Manche contre coudé	230 mm, 400 g (72410)
Articulación universal / Universal Joint / Cardan Universel	80 mm (70372)
Alargadera / Extension / Rallonge	125-250 mm (70385)
Berbiquí / Speeder handle / Vilebrequin	390 mm (72416)
Mango corredizo en T / Sliding T handle / Poignée coulissante	250 mm (70378)
Carraca / Ratchet / Cliquet	250 mm (70375)



**Cu-Be** Cobre berilio / Beryllium copper / Cuivre beryllium / Kupfer beryllium / Koper beryllium / Rame-berillio / Сплав Медь Бериллий  
**Al-Bron** Aluminio bronce / Aluminium bronze / Alliage aluminium-bronze / Alliage aluminium-bronze / Aluminium brons / Aluminio bronzo / Сплав Алюминий Бронза



05

**ANTICHISPA  
NON-SPARKING  
ANTIDÉFLAGRANT  
FUNKENFREI  
ANTISCINTILLA  
ANTI-DEFLAGRANTE  
ИСКРОБЕЗОПАСНЫЙ**



1/2"

COD.	MAT.	AF inch	PCS.	COD. PCS.	AF mm	AF inch	Kg
74274				74477, 74478, 74479, 74480, 74481, 74482, 74483, 74484, 74485, 74486, 74487, 74488, 74489, 74490, 74491, 74492, 74493, 74495, 74496, 74497, 74499, 74500	8-9-10-11-12-13-14-15-16-17-18-19-20-21-22-23-24-26-27-28-30-32		
35824	Al-Bron	1/2	31	74521, 35851, 74522, 74523, 74524, 74525, 74526, 74527, 74528, 35853, 74529, 74530, 74531, 74532, 35855, 74533, 74534, 74535, 74536, 77791, 74537	-	5/16"-11/32"-3/8"-7/16"-1/4"-1/2"-9/16"-19/32"-5/8"-11/16"-23/32"-3/4"-25/32"-13/16"-7/8"-29/32"-15/16"-1"-1.1/16"-1.1/8"-1.3/16"-1.1/4"	6,5
ESPECIFICACIONES TÉCNICAS / TECHNICAL SPECIFICATION / DÉTAILS TECHNIQUES							
Vaso para bujías / Spark plug socket / Douille à bougie					13/16"		
Punta plana con vaso / Flat bit socket / Embout fente à douille					13 x 2 mm (73710)		
Mango acodado / Offset handle / Manche contre coudé					230 mm, 400 g (72411)		
Articulación universal / Universal Joint / Cardan Universel					80 mm (71269)		
Alargadera / Extension / Rallonge					125-250 mm (71281)		
Berbiquí / Speeder handle / Vilebrequin					390 mm (72417)		
Mango corredizo en T / Sliding T handle / Poignée coulissante					250 mm (71274)		
Carraca / Ratchet / Cliquet					250 mm (71272)		

3/4"

COD.	MAT.	AF inch	PCS.	COD. PCS.	AF mm	AF inch	Kg
74275				75740, 74538, 74540, 74541, 74542, 75750, 74543, 75752, 74544, 74545, 74546	21-24-27-30-32-34-36-38-41-46-50		
35816	Cu-Be	3/4	14	75756, 75760, 75764, 75768, 75770, 74557, 74558, 74559, 74561, 74564, 74566	-	13/16"-15/16"-1-1/16"-1.3/16"-1.1/4"-1.3/8"-1.7/16"-1.1/2"-1.5/8"-1.13/16"-2"	8,5
ESPECIFICACIONES TÉCNICAS / TECHNICAL SPECIFICATION / DÉTAILS TECHNIQUES							
Alargadera / Extension / Rallonge					200 mm (70387)		
Mango corredizo en T / Sliding T handle / Poignée coulissante					400 mm		
Carraca / Ratchet / Cliquet					320 mm (70376)		
COD.	MAT.	AF inch	PCS.	COD. PCS.	AF mm	AF inch	Kg
74276				75741, 74547, 74549, 74550, 74551, 75751, 74552, 75753, 74553, 74554, 74555	21-24-27-30-32-34-36-38-41-46-50		
35825	Al-Bron	3/4	14	75757, 75761, 75765, 75769, 75771, 74568, 74569, 74570, 74572, 74575, 74577	-	13/16"-15/16"-1-1/16"-1.3/16"-1.1/4"-1.3/8"-1.7/16"-1.1/2"-1.5/8"-1.13/16"-2"	8,5
ESPECIFICACIONES TÉCNICAS / TECHNICAL SPECIFICATION / DÉTAILS TECHNIQUES							
Alargadera / Extension / Rallonge					200 mm (71283)		
Mango corredizo en T / Sliding T handle / Poignée coulissante					400 mm		
Carraca / Ratchet / Cliquet					320 mm (71273)		



**Cu-Be** Cobre berilio / Beryllium copper / Cuivre beryllium / Kupfer beryllium / Koper beryllium / Rame-berillio / Сплав Медь Бериллий  
**Al-Bron** Aluminio bronce / Aluminium bronze / Alliage aluminium-bronze / Alliage aluminium-bronze / Aluminium brons / Aluminio bronzo / Сплав Алюминий Бронза

Si no encuentra el artículo que necesita, consúltenos en [info@egamaster.com](mailto:info@egamaster.com) o en [www.egamaster.com](http://www.egamaster.com)  
 If you can't find the item you look for, please ask us in [info@egamaster.com](mailto:info@egamaster.com) or in [www.egamaster.com](http://www.egamaster.com)  
 Si vous ne trouvez pas l'article que vous désirez, consultez-nous à [info@egamaster.com](mailto:info@egamaster.com) ou à [www.egamaster.com](http://www.egamaster.com)

**EGAMaster**  
ART IN INNOVATION

05

**ANTICHISPA  
NON-SPARKING  
ANTIDÉFLAGRANT  
FUNKENFREI  
ANTISCINTILLA  
ANTI-DEFLAGRANTE  
ИСКРОБЕЗОПАСНЫЙ**



Management System  
ISO 9001:2015  
ISO 14001:2015  
www.tuc.com  
ID 0910098048



3/4"

COD.	MAT.	AF inch	PCS.	COD. PCS.	AF mm	AF inch	Kg
<b>74277</b>				75740, 75742, 74538, 74539, 74540, 75744, 75746, 74541, 75748, 74542, 75750, 74543, 75752, 74544, 74545, 74546	21-22-23-24-26-27-28-29-30-31-32-34-36-38-41-46-50	-	
<b>35817</b>	Cu-Be	3/4	20	75754, 75756, 75758, 75760, 75762, 75764, 75766, 35856, 75768, 35858, 75770, 74557, 74558, 74559, 74561, 74564, 74566	-	3/4"-13/16"-7/8"-15/16"-1"-1.1/16"-1.1/8"-1.5/32"-1.3/16"-1.7/32"-1.1/4"-1.3/8"-1.7/16"-1.1/2"-1.5/8"-1.13/16"-2"	8,5

**ESPECIFICACIONES TÉCNICAS / TECHNICAL SPECIFICATION / DÉTAILS TECHNIQUES**

Alargadera / Extension / Rallonge	200 mm (70387)
Mango corredizo en T / Sliding T handle / Poignée coulissante	400 mm
Carraca / Ratchet / Cliquet	320 mm (70376)



COD.	MAT.	AF inch	PCS.	COD. PCS.	AF mm	AF inch	Kg
<b>74278</b>				75741, 75743, 74547, 74548, 74549, 75745, 75747, 74550, 75749, 74551, 75751, 74552, 75753, 74553, 74554, 74555	21-22-23-24-26-27-28-29-30-31-32-34-36-38-41-46-50	-	
<b>35826</b>	Al-Bron	3/4	20	75755, 75757, 75759, 75761, 75763, 75765, 75767, 35857, 75769, 35859, 75771, 74568, 74569, 74570, 74572, 74575, 74577	-	3/4"-13/16"-7/8"-15/16"-1"-1.1/16"-1.1/8"-1.5/32"-1.3/16"-1.7/32"-1.1/4"-1.3/8"-1.7/16"-1.1/2"-1.5/8"-1.13/16"-2"	8,5

**ESPECIFICACIONES TÉCNICAS / TECHNICAL SPECIFICATION / DÉTAILS TECHNIQUES**

Alargadera / Extension / Rallonge	200 mm (71283)
Mango corredizo en T / Sliding T handle / Poignée coulissante	400 mm
Carraca / Ratchet / Cliquet	320 mm (71273)

1"

COD.	MAT.	AF inch	PCS.	COD. PCS.	AF mm	AF inch	Kg
<b>74279</b>				74541, 75748, 74542, 75750, 74543, 75752, 74544, 74545, 74546, 77822, 77824	30-31-32-34-36-38-41-46-50-55-60-65-70-75-80	-	
<b>35818</b>	Cu-Be	1	18	75766, 75768, 75770, 74557, 74558, 74559, 74561, 74564, 74566	-	1.1/8"-1.3/16"-1.1/4"-1.3/8"-1.7/16"-1.1/2"-1.5/8"-1.13/16"-2"-2.1/4"-2.3/8"-2.9/16"-2.3/4"-2.15/16"-3.1/8"	18

**ESPECIFICACIONES TÉCNICAS / TECHNICAL SPECIFICATION / DÉTAILS TECHNIQUES**

Articulación flexible / Flexible joint / Articulation universelle	120 mm (72396)
Alargadera / Extension / Rallonge	200 mm (70387)
Mango corredizo en T / Sliding T handle / Poignée coulissante	400 mm



COD.	MAT.	AF inch	PCS.	COD. PCS.	AF mm	AF inch	Kg
<b>74280</b>				74550, 75749, 74551, 75751, 74552, 75753, 74553, 74554, 74555, 77823, 77825	30-31-32-34-36-38-41-46-50-55-60-65-70-75-80	-	
<b>35827</b>	Al-Bron	1	18	75767, 75769, 75771, 74568, 74569, 74570, 74572, 74575, 74577	-	1.1/8"-1.3/16"-1.1/4"-1.3/8"-1.7/16"-1.1/2"-1.5/8"-1.13/16"-2"-2.1/4"-2.3/8"-2.9/16"-2.3/4"-2.15/16"-3.1/8"	18

**ESPECIFICACIONES TÉCNICAS / TECHNICAL SPECIFICATION / DÉTAILS TECHNIQUES**

Articulación flexible / Flexible joint / Articulation universelle	120 mm (72397)
Alargadera / Extension / Rallonge	200 mm (71283)
Mango corredizo en T / Sliding T handle / Poignée coulissante	400 mm

**Cu-Be** Cobre berilio / Beryllium copper / Cuivre beryllium / Kupfer beryllium / Koper beryllium / Rame-berillio / Сплав Медь Бериллий  
**Al-Bron** Aluminio bronce / Aluminium bronze / Alliage aluminium-bronze / Alliage aluminium-bronze / Aluminium brons / Aluminio bronzo / Сплав Алюминий Бронза

05

ANTICHISPA  
NON-SPARKING  
ANTIDÉFLAGRANT  
FUNKENFREI  
ANTISCINTILLA  
ANTI-DEFLAGRANTE  
ИСКРБЕЗОПАСНЫЙ



LLAVES DE VASO DE IMPACTO / IMPACT SOCKET WRENCHES / DOUILLES À CHOC / IMPACT STECKSCHLÜSSEL EINSÄTZE / BUSSOLA AD IMPULSI / CHAVES DE CAIXA DE IMPACTO / УДАРНАЯ ГОЛОВКА

■ 1/2"

■ STANDARD

■ MM

■ 6 PT.

■ 12 PT.



COD.	MAT.	COD.	MAT.	AF mm	L (mm)	Pt	g	COD.	MAT.	COD.	MAT.	AF mm	L (mm)	Pt	g
77852		77853		8			105	77930		77931		8			105
77854		77855		9	42			77932		77933		9	42		
77856		77857		10			115	76496		76497		10			115
77858		77859		11				76498		76499		11			
77860		77861		12			135	76500		76501		12			135
77862		77863		13				76502		76503		13			
77864		77865		14			145	76504		76505		14			145
77866		77867		15				76506		76507		15			
77868		77869		16				76508		76509		16			
77870		77871		17	44		160	74775		74776		17	44		160
77872		77873		18				77934		77935		18			
77874		77875		19				74777		74778		19			
77876		77877		20				77936		77937		20			
74717	Cu-Be	74718	Al-Bron	21		6	180	77938	Cu-Be	77939	Al-Bron	21		12	180
77878		77879		22				74779		74780		22			
77880		77881		23				76510		76511		23			
74719		74720		24			200	77940		77941		24			200
77882		77883		25	46			77942		77943		25	46		
77884		77885		26			210	77944		77945		26			210
77886		77887		27				74781		74782		27			
77888		77889		28	48		220	77946		77947		28	48		220
77890		77891		29			230	77948		77949		29			230
74721		74722		30			240	77950		77951		30			240
77892		77893		32			250	74783		74784		32			250
74723		74724		41	50		260	77952		77953		41	50		260
74725		74726		46			600	77954		77955		46			600
74716		74727		50	60		800	36458		36459		50	60		800



Llaves de Impacto - Neumáticas e Hidráulicas, Cuadrado 1/2", 3/4", 1" y 1.1/2" - Certificados ATEX para uso en zonas Ex: Ex II 2 GcT6 y Ex II 2 GcT5 - Ver capítulo de Seguridad Intrínseca.  
Impact Wrenches - Pneumatic and Hydraulic, 1/2", 3/4", 1" and 1.1/2" Sq. Drive - ATEX Certified for use in Ex Zones: Ex II 2 GcT6 y Ex II 2 GcT5 - See Intrinsic Safety chapter.  
Douilles à choc - Pneumatiques et Hydrauliques, Carrée de 1/2", 3/4", 1" et 1.1/2" - Certifiés ATEX pour usage dans les zones Ex: Ex II 2 GcT6 et Ex II 2 GcT5 - Voir chapitre Sécurité Intrinsèque.

**Cu-Be** Cobre berilio / Beryllium copper / Cuivre beryllium / Kupfer beryllium / Koper beryllium / Rame-berillio / Сплав Медь Бериллий  
**Al-Bron** Aluminio bronce / Aluminium bronze / Alliage aluminium-bronze / Alliage aluminium-bronze / Aluminium brons / Aluminio bronzo / Сплав Алюминий Бронза

Si no encuentra el artículo que necesita, consúltenos en [info@egamaster.com](mailto:info@egamaster.com) o en [www.egamaster.com](http://www.egamaster.com)  
If you can't find the item you look for, please ask us in [info@egamaster.com](mailto:info@egamaster.com) or in [www.egamaster.com](http://www.egamaster.com)  
Si vous ne trouvez pas l'article que vous desirez, consultez-nous a [info@egamaster.com](mailto:info@egamaster.com) ou a [www.egamaster.com](http://www.egamaster.com)

05

ANTICHISPA  
NON-SPARKING  
ANTIDÉFLAGRANT  
FUNKENFREI  
ANTISCINTILLA  
ANTI-DEFLAGRANTE  
ИСКРОБЕЗОПАСНЫЙ



1/2"

■ STANDARD

■ INCH

■ 6 PT.



COD.	MAT.	COD.	MAT.	AF inch	L (mm)	Pt	g
77894		77895		5/16			105
77896		77897		3/8	42		110
77898		77899		7/16			115
77900		77901		1/2			
77902		77903		9/16		145	
77904		77905		19/32			
77906		77907		5/8			
77908		77909		11/16		160	
77910		77911		3/4			
77912	Cu-Be	77913	Al-Bron	25/32		6	180
77914		77915		13/16	44		
77916		77917		7/8			
77918		77919		15/16			
77920		77921		1			200
77922		77923		1.1/16			
77924		77925		1.1/8			220
77926		77927		1.3/16			240
77928		77929		1.1/4			250

■ 12 PT.



COD.	MAT.	COD.	MAT.	AF inch	L (mm)	Pt	g
77956		77957		5/16			105
77958		77959		3/8	42		110
77960		77961		7/16			115
77962		77963		1/2			
77964		77965		9/16		145	
77966		77967		19/32			
77968		77969		5/8			
77970		77971		11/16		160	
77972		77973		3/4			
77974	Cu-Be	77975	Al-Bron	25/32		12	180
77976		77977		13/16	44		
77978		77979		7/8			
77980		77981		15/16			
77982		77983		1			200
77984		77985		1.1/16			
77986		77987		1.1/8			220
77988		77989		1.3/16			240
77990		77991		1.1/4			250



Llaves de Impacto - Neumáticas e Hidráulicas, Cuadrado 1/2", 3/4", 1" y 1.1/2" - Certificados ATEX para uso en zonas Ex: Ex II 2 GcT6 y Ex II 2 GcT5 - Ver capítulo de Seguridad Intrínseca.  
Impact Wrenches - Pneumatic and Hydraulic, 1/2", 3/4", 1" and 1.1/2" Sq. Drive - ATEX Certified for use in Ex Zones: Ex II 2 GcT6 y Ex II 2 GcT5 - See Intrinsic Safety chapter.  
Douilles à choc - Pneumatiques et Hydrauliques, Carrée de 1/2", 3/4", 1" et 1.1/2" - Certifiés ATEX pour usage dans les zones Ex: Ex II 2 GcT6 et Ex II 2 GcT5 - Voir chapitre Sécurité Intrinsèque.

**Cu-Be** Cobre berilio / Beryllium copper / Cuivre beryllium / Kupfer beryllium / Koper beryllium / Rame-berillio / Сплав Медь Бериллий  
**Al-Bron** Aluminio bronce / Aluminium bronze / Alliage aluminium-bronze / Alliage aluminium-bronze / Aluminium brons / Aluminio bronzo / Сплав Аллюминий Бронза

05

**ANTICHISPA  
NON-SPARKING  
ANTIDÉFLAGRANT  
FUNKENFREI  
ANTISCINTILLA  
ANTI-DEFLAGRANTE  
ИСКРБЕЗОПАСНЫЙ**



1/2"

■ **SERIE LARGA / LONG SOCKETS / SÉRIE LONGUE / LANGE SERIE / SERIE LUNGA / SERIE LONGA / ВЫСОКАЯ СЕРИЯ**■ **MM**■ **6 PT.**■ **12 PT.**

COD.	MAT.	COD.	MAT.	AF mm	L (mm)	Pt	g	COD.	MAT.	COD.	MAT.	AF mm	L (mm)	Pt	g
76202		76203		8				76990		76991		8			
76204		76205		9				76992		76993		9			
76206		76207		10		170		76994		76995		10		170	
76208		76209		11				76996		76997		11			
76210		76211		12				76998		76999		12			
76212		76213		13		180		78389		78390		13		180	
76214		76215		14		190		78391		78392		14		190	
76216		76217		15		200		78393		78394		15		200	
76218		76219		16		220		78395		78396		16		220	
76220		76221		17		240		78397		78398		17		240	
76222		76223		18		260		78399		78400		18		260	
76224		76225		19		270		78401		78402		19		270	
76226		76227		20		280		78403		78404		20		280	
76228	Cu-Be	76229	Al-Bron	21	82	6	290	78405	Cu-Be	78406	Al-Bron	21	82	12	290
76230		76231		22			310	78407		78408		22			310
76232		76233		23			320	78409		78410		23			320
76766		76767		24			340	78411		78412		24			340
76234		76235		25			380	78413		78414		25			380
76236		76237		26			400	78415		78416		26			400
76768		76769		27			420	78417		78418		27			420
76280		76281		28			440	78419		78420		28			440
76282		76283		29			460	78421		78422		29			460
76770		76771		30			500	78423		78424		30			500
76772		76773		32				78425		78426		32			500
76284		76285		41			800	78427		78428		41			800
76286		76287		46			1000	78429		78430		46			1000
36456		36457		50			1275	36460		36461		50			1275



LLAVES DE IMPACTO - Neumáticas e Hidráulicas, Cuadrado 1/2", 3/4", 1" y 1.1/2" - Certificados ATEX para uso en zonas Ex: Ex II 2 GcT6 y Ex II 2 GcT5 - Ver capítulo de Seguridad Intrínseca.  
Impact Wrenches - Pneumatic and Hydraulic, 1/2", 3/4", 1" and 1.1/2" Sq. Drive - ATEX Certified for use in Ex Zones: Ex II 2 GcT6 y Ex II 2 GcT5 - See Intrinsic Safety chapter.  
Douilles à choc - Pneumatiques et Hydrauliques, Carrée de 1/2", 3/4", 1" et 1.1/2" - Certifiés ATEX pour usage dans les zones Ex: Ex II 2 GcT6 et Ex II 2 GcT5 - Voir chapitre Sécurité Intrinsèque.

**Cu-Be** Cobre berilio / Beryllium copper / Cuivre beryllium / Kupfer beryllium / Koper beryllium / Rame-berillio / Сплав Медь Бериллий  
**Al-Bron** Aluminio bronce / Aluminium bronze / Alliage aluminium-bronze / Alliage aluminium-bronze / Aluminium brons / Aluminio bronzo / Сплав Алюминий Бронза

Si no encuentra el artículo que necesita, consúltenos en [info@egamaster.com](mailto:info@egamaster.com) o en [www.egamaster.com](http://www.egamaster.com)  
If you can't find the item you look for, please ask us in [info@egamaster.com](mailto:info@egamaster.com) or in [www.egamaster.com](http://www.egamaster.com)  
Si vous ne trouvez pas l'article que vous désirez, consultez-nous à [info@egamaster.com](mailto:info@egamaster.com) ou à [www.egamaster.com](http://www.egamaster.com)



05

**ANTICHISPA**  
**NON-SPARKING**  
**ANTIDÉFLAGRANT**  
**FUNKENFREI**  
**ANTISCINTILLA**  
**ANTI-DEFLAGRANTE**  
**ИСКРОБЕЗОПАСНЫЙ**



Management System  
 ISO 9001:2015  
 ISO 14001:2015  
 www.tuc.com  
 ID 0910098048



1/2"

■ SERIE LARGA / LONG SOCKETS / SÉRIE LONGUE / LANGE SERIE / SERIE LUNGA / SERIE LONGA / ВЫСОКАЯ СЕРИЯ

■ INCH

■ 6 PT.

■ 12 PT.



COD.	MAT.	COD.	MAT.	AP inch	L (mm)	Pt	g
76352		76353		5/16			
76354		76355		3/8		170	
76356		76357		7/16			
76358		76359		1/2		180	
76360		76361		9/16		190	
76362		76363		19/32		200	
76364		76365		5/8		220	
76366		76367		11/16		250	
76368		76369		3/4		270	
76370	Cu-Be	76371	Al-Bron	25/32	82	6	280
76372		76373		13/16		290	
76374		76375		7/8		310	
76376		76377		15/16		340	
76378		76379		1		380	
76380		76381		1.1/16		420	
76382		76383		1.1/8		460	
76384		76385		1.3/16		490	
76386		76387		1.1/4		500	

COD.	MAT.	COD.	MAT.	AP inch	L (mm)	Pt	g
78431		78432		5/16			
78433		78434		3/8		170	
78435		78436		7/16			
78437		78438		1/2		180	
78439		78440		9/16		190	
78441		78442		19/32		200	
78443		78444		5/8		220	
78445		78446		11/16		250	
78447		78448		3/4		270	
78449	Cu-Be	78450	Al-Bron	25/32	82	12	280
78451		78452		13/16		290	
78453		78454		7/8		310	
78455		78456		15/16		340	
78457		78458		1		380	
78459		78460		1.1/16		420	
78461		78462		1.1/8		460	
78463		78464		1.3/16		490	
78465		78466		1.1/4		500	



Llaves de Impacto - Neumáticas e Hidráulicas, Cuadrado 1/2", 3/4", 1" y 1.1/2" - Certificados ATEX para uso en zonas Ex: Ex II 2 GcT6 y Ex II 2 GcT5 - Ver capítulo de Seguridad Intrínseca.  
 Impact Wrenches - Pneumatic and Hydraulic, 1/2", 3/4", 1" and 1.1/2" Sq. Drive - ATEX Certified for use in Ex Zones: Ex II 2 GcT6 y Ex II 2 GcT5 - See Intrinsic Safety chapter.  
 Douilles à choc - Pneumatiques et Hydrauliques, Carrée de 1/2", 3/4", 1" et 1.1/2" - Certifiés ATEX pour usage dans les zones Ex: Ex II 2 GcT6 et Ex II 2 GcT5 - Voir chapitre Sécurité Intrinsèque.

**Cu-Be** Cobre berilio / Beryllium copper / Cuivre beryllium / Kupfer beryllium / Koper beryllium / Rame-berillio / Сплав Медь Бериллий  
**Al-Bron** Aluminio bronce / Aluminium bronze / Alliage aluminium-bronze / Alliage aluminium-bronze / Aluminium brons / Aluminio bronzo / Сплав Алюминий Бронза

# 05

**ANTICHISPA  
NON-SPARKING  
ANTIDÉFLAGRANT  
FUNKENFREI  
ANTISCINTILLA  
ANTI-DEFLAGRANTE  
ИСКРБЕЗОПАСНЫЙ**



- 3/4"
- STANDARD
- MM
- 6 PT.

- 12 PT.



COD.	MAT.	COD.	MAT.	AF mm	L (mm)	Pt	g
79839		79840		17			
77992		77993		19			
79841		79842		21		350	
77994		77995		22	55		
75884		75885		24			
79879		79880		26		370	
75886		75887		27		380	
79881		79882		28	50	400	
75888		75889		30		500	
75890	Cu-Be	75891	Al-Bron	32		6	
79843		79844		33	60		
77996		77997		34		550	
75892		75893		36			
77998		77999		38		700	
75894		75895		41	65	800	
75896		75897		46		900	
75898		75899		50		1100	
78000		78001		55	70	1250	
78002		78003		60			

COD.	MAT.	COD.	MAT.	AF mm	L (mm)	Pt	g
78040		78041		19			
78042		78043		22	55		350
72314		72315		24			
72316		72317		27			380
72318		72319		30			500
72320		72321		32	60		
76512	Cu-Be	76513	Al-Bron	34		12	550
72322		72323		36			
76514		76515		38			700
72324		72325		41	65		800
72326		72327		46			900
72328		72329		50			1100
76516		76517		55	70		1250
78044		75968		60			



Llaves de Impacto - Neumáticas e Hidráulicas, Cuadrado 1/2", 3/4", 1" y 1.1/2" - Certificados ATEX para uso en zonas Ex: Ex II 2 GcT6 y Ex II 2 GcT5 - Ver capítulo de Seguridad Intrínseca.  
Impact Wrenches - Pneumatic and Hydraulic, 1/2", 3/4", 1" and 1.1/2" Sq. Drive - ATEX Certified for use in Ex Zones: Ex II 2 GcT6 y Ex II 2 GcT5 - See Intrinsic Safety chapter.  
Douilles à choc - Pneumatiques et Hydrauliques, Carrée de 1/2", 3/4", 1" et 1.1/2" - Certifiés ATEX pour usage dans les zones Ex: Ex II 2 GcT6 et Ex II 2 GcT5 - Voir chapitre Sécurité Intrinsèque.

**Cu-Be** Cobre berilio / Beryllium copper / Cuivre beryllium / Kupfer beryllium / Koper beryllium / Rame-berillio / Сплав Медь Бериллий  
**Al-Bron** Aluminio bronce / Aluminium bronze / Alliage aluminium-bronze / Alliage aluminium-bronze / Aluminium brons / Aluminio bronzo / Сплав Алюминий Бронза

Si no encuentra el artículo que necesita, consúltenos en [info@egamaster.com](mailto:info@egamaster.com) o en [www.egamaster.com](http://www.egamaster.com)  
If you can't find the item you look for, please ask us in [info@egamaster.com](mailto:info@egamaster.com) or in [www.egamaster.com](http://www.egamaster.com)  
Si vous ne trouvez pas l'article que vous desirez, consultez-nous a [info@egamaster.com](mailto:info@egamaster.com) ou a [www.egamaster.com](http://www.egamaster.com)



05

**ANTICHISPA  
NON-SPARKING  
ANTIDÉFLAGRANT  
FUNKENFREI  
ANTISCINTILLA  
ANTI-DEFLAGRANTE  
ИСКРОБЕЗОПАСНЫЙ**



3/4"

■ STANDARD

■ INCH

■ 6 PT.



COD.	MAT.	COD.	MAT.	AF inch	L (mm)	Pt	g
79883		79884		9/16	50		320
79885		79886		5/8			340
78004		78005		3/4			430
78006		78007		13/16	55	450	
78008		78009		7/8			
78010		78011		15/16			
78012		78013		1	60	6	600
78014		78015		1.1/16			
78016		78017		1.1/8			
78018		78019		1.3/16	65	700	
78020	Cu-Be	78021	Al-Bron	1.1/4			
78022		78023		1.5/16			
78024		78025		1.3/8	70	850	
78026		78027		1.7/16			
78028		78029		1.1/2			
78030		78031		1.5/8	60	670	
79887		79888		1.11/16			
78032		78033		1.3/4			
78034		78035		1.7/8	65	1200	
78036		78037		1.13/16			
78038		78039		2			

■ 12 PT.



COD.	MAT.	COD.	MAT.	AF inch	L (mm)	Pt	g
78045		78046		3/4	55	450	430
78047		78048		13/16			
78049		78050		7/8			
78051		78052		15/16	60	12	650
78053		78054		1			
78055		78056		1.1/16			
78057		78058		1.1/8	65	700	850
78059		78060		1.3/16			
78061	Cu-Be	78062	Al-Bron	1.1/4			
78063		78064		1.5/16	70	850	1200
78065		78066		1.3/8			
78067		78068		1.7/16			
78069		78070		1.1/2	70	1250	
78071		78072		1.5/8			
78073		78074		1.3/4			
78075		78076		1.7/8	70	1250	
78077		78078		1.13/16			
78079		78080		2			



Llaves de Impacto - Neumáticas e Hidráulicas, Cuadrado 1/2", 3/4", 1" y 1.1/2" - Certificados ATEX para uso en zonas Ex: Ex II 2 GcT6 y Ex II 2 GcT5 - Ver capítulo de Seguridad Intrínseca.  
Impact Wrenches - Pneumatic and Hydraulic, 1/2", 3/4", 1" and 1.1/2" Sq. Drive - ATEX Certified for use in Ex Zones: Ex II 2 GcT6 y Ex II 2 GcT5 - See Intrinsic Safety chapter.  
Douilles à choc - Pneumatiques et Hydrauliques, Carrée de 1/2", 3/4", 1" et 1.1/2" - Certifiés ATEX pour usage dans les zones Ex: Ex II 2 GcT6 et Ex II 2 GcT5 - Voir chapitre Sécurité Intrinsèque.

**Cu-Be** Cobre berilio / Beryllium copper / Cuivre beryllium / Kupfer beryllium / Koper beryllium / Rame-berillio / Сплав Медь Бериллий  
**Al-Bron** Aluminio bronce / Aluminium bronze / Alliage aluminium-bronze / Alliage aluminium-bronze / Aluminium brons / Aluminio bronzo / Сплав Алюминий Бронза



05

**ANTICHISPA  
NON-SPARKING  
ANTIDÉFLAGRANT  
FUNKENFREI  
ANTISCINTILLA  
ANTI-DEFLAGRANTE  
ИСКРОБЕЗОПАСНЫЙ**



3/4"

■ **SERIE LARGA / LONG SOCKETS / SÉRIE LONGUE / LANGE SERIE / SERIE LUNGA / SERIE LONGA / ВЫСОКАЯ СЕРИЯ**■ **MM**■ **6 PT.**■ **12 PT.**

COD.	MAT.	COD.	MAT.	AF mm	L (mm)	Pt	g
78467		78468		19	90	6	800
78469		78470		22			
78471		78472		24			
78473		78474		27			
78475		78476		30	95	6	900
78477		78478		32			
78479		78480		34			
78481		78482		36			
78483		78484		38	100	6	1100
78485		78486		41			
78487		78488		46			
78489		78490		50			
78491		78492		55	1750	6	1200
78493		78494		60			

COD.	MAT.	COD.	MAT.	AF mm	L (mm)	Pt	g
78531		78532		19	90	6	800
78533		78534		22			
78535		78536		24			
78537		78538		27			
78539		78540		30	95	6	900
78541		78542		32			
78543		78544		34			
78545		78546		36			
78547		78548		38	100	6	1100
78549		78550		41			
78551		78552		46			
78553		78554		50			
78555		78556		55	1700	6	1200
78557		78558		60			



Llaves de Impacto - Neumáticas e Hidráulicas, Cuadrado 1/2", 3/4", 1" y 1.1/2" - Certificados ATEX para uso en zonas Ex: Ex II 2 GcT6 y Ex II 2 GcT5 - Ver capítulo de Seguridad Intrínseca.  
Impact Wrenches - Pneumatic and Hydraulic, 1/2", 3/4", 1" and 1.1/2" Sq. Drive - ATEX Certified for use in Ex Zones: Ex II 2 GcT6 y Ex II 2 GcT5 - See Intrinsic Safety chapter.  
Douilles à choc - Pneumatiques et Hydrauliques, Carrée de 1/2", 3/4", 1" et 1.1/2" - Certifiés ATEX pour usage dans les zones Ex: Ex II 2 GcT6 et Ex II 2 GcT5 - Voir chapitre Sécurité Intrinsèque.

**Cu-Be** Cobre berilio / Beryllium copper / Cuivre beryllium / Kupfer beryllium / Koper beryllium / Rame-berillio / Сплав Медь Бериллий  
**Al-Bron** Aluminio bronce / Aluminium bronze / Alliage aluminium-bronze / Alliage aluminium-bronze / Aluminium brons / Aluminio bronzo / Сплав Алюминий Бронза

Si no encuentra el artículo que necesita, consúltenos en [info@egamaster.com](mailto:info@egamaster.com) o en [www.egamaster.com](http://www.egamaster.com)  
If you can't find the item you look for, please ask us in [info@egamaster.com](mailto:info@egamaster.com) or in [www.egamaster.com](http://www.egamaster.com)  
Si vous ne trouvez pas l'article que vous desirez, consultez-nous a [info@egamaster.com](mailto:info@egamaster.com) ou a [www.egamaster.com](http://www.egamaster.com)

**EGAMaster**  
ART IN INNOVATION

05

ANTICHISPA  
NON-SPARKING  
ANTIDÉFLAGRANT  
FUNKENFREI  
ANTISCINTILLA  
ANTI-DEFLAGRANTE  
ИСКРБЕЗОПАСНЫЙ



3/4"

■ SERIE LARGA / LONG SOCKETS / SÉRIE LONGUE / LANGE SERIE / SERIE LUNGA / SERIE LONGA / ВЫСОКАЯ СЕРИЯ

■ INCH

■ 6 PT.

■ 12 PT.



COD.	MAT.	COD.	MAT.	AP inch	L (mm)	Pt	g	COD.	MAT.	COD.	MAT.	AP inch	L (mm)	Pt	g
78495		78496		3/4				78559		78560		3/4			
78497		78498		13/16				78561		78562		13/16			
78499		78500		7/8	90		800	78563		78564		7/8	90		800
78501		78502		15/16				78565		78566		15/16			
78503		78504		1				78567		78568		1			
78505		78506		1.1/16				78569		78570		1.1/16			
78507		78508		1.1/8				78571		78572		1.1/8			
78509		78510		1.3/16				78573		78574		1.3/16			
78511	Cu-Be	78512	Al-Bron	1.1/4	95	6	900	78575	Cu-Be	78576	Al-Bron	1.1/4	95	12	900
78513		78514		1.5/16				78577		78578		1.5/16			
78515		78516		1.3/8				78579		78580		1.3/8			
78517		78518		1.7/16				78581		78582		1.7/16			
78519		78520		1.1/2			1100	78583		78584		1.1/2			1100
78521		78522		1.5/8			1150	78585		78586		1.5/8			1150
78523		78524		1.3/4	100			78587		78588		1.3/4	100		
78525		78526		1.13/16			1200	78589		78590		1.13/16			1200
78527		78528		1.7/8				78591		78592		1.7/8			
78529		78530		2			1700	78593		78594		2			1700



Llaves de Impacto - Neumáticas e Hidráulicas, Cuadrado 1/2", 3/4", 1" y 1.1/2" - Certificados ATEX para uso en zonas Ex: Ex II 2 GcT6 y Ex II 2 GcT5 - Ver capítulo de Seguridad Intrínseca.  
Impact Wrenches - Pneumatic and Hydraulic, 1/2", 3/4", 1" and 1.1/2" Sq. Drive - ATEX Certified for use in Ex Zones: Ex II 2 GcT6 y Ex II 2 GcT5 - See Intrinsic Safety chapter.  
Dovilles à choc - Pneumatiques et Hydrauliques, Carrée de 1/2", 3/4", 1" et 1.1/2" - Certifiés ATEX pour usage dans les zones Ex: Ex II 2 GcT6 et Ex II 2 GcT5 - Voir chapitre Sécurité Intrinsèque.

**Cu-Be** Cobre berilio / Beryllium copper / Cuivre beryllium / Kupfer beryllium / Koper beryllium / Rame-berillio / Сплав Медь Бериллий  
**Al-Bron** Aluminio bronce / Aluminium bronze / Alliage aluminium-bronze / Alliage aluminium-bronze / Aluminium brons / Aluminio bronzo / Сплав Алюминий Бронза

- 1"
- STANDARD
- MM
- 6 PT.

- 12 PT.



COD.	MAT.	COD.	MAT.	AF mm	L (mm)	Pt	g
72330		72331		19			650
72332		72333		21			650
72334		72335		22			
72336		72337		24			
72338		72339		26	60		700
72340		72341		27			
72342		72343		29			
72344		72345		30			750
72346		72347		32			
72348		72349		34			800
72350		72351		35			
72352		72353		36	70		850
72354		72355		38			
72356		72357		41			900
72358		72359		46	80		1200
72360	Cu-Be	72361	Al-Bron	50	80	6	1500
72362		72363		52			1700
72364		72365		55			1800
72366		72367		58			1900
72368		72369		60			2000
72370		72371		65	90		2300
72372		72373		70			2700
72374		72375		75			3000
72376		72377		80			3300
79845		79846		85			3500
79847		79848		90			3700
79869		79870		95	100		4000
79871		79872		100			4500
79873		79874		105	110		5500
79875		79876		110			5750
79877		79878		115	115		7000

COD.	MAT.	COD.	MAT.	AF mm	L (mm)	Pt	g
75900		75901		19			650
75902		75903		21			650
75904		75905		22			
75906		75907		24			
75908		75909		26	60		700
75910		75911		27			
75912		75913		29			
75914		75915		30			750
75916		75917		32			
75918		75919		34			800
75920		75921		35			
75922	Cu-Be	75923	Al-Bron	36	70	12	850
75924		75925		38			900
75926		75927		41			
75928		75929		46	80		1200
75930		75931		50	80		1500
75932		75933		52			1700
75934		75935		55			1800
75936		75937		58			1900
75938		75939		60			2000
75940		75941		65	90		2300
75942		75943		70			2700
75944		75945		75			3000
75946		75947		80			3300



LLAVES DE IMPACTO - Neumáticas e Hidráulicas, Cuadrado 1/2", 3/4", 1" y 1.1/2" - Certificados ATEX para uso en zonas Ex: Ex II 2 GcT6 y Ex II 2 GcT5 - Ver capítulo de Seguridad Intrínseca.  
Impact Wrenches - Pneumatic and Hydraulic, 1/2", 3/4", 1" and 1.1/2" Sq. Drive - ATEX Certified for use in Ex Zones: Ex II 2 GcT6 y Ex II 2 GcT5 - See Intrinsic Safety chapter.  
Dovilles à choc - Pneumatiques et Hydrauliques, Carrée de 1/2", 3/4", 1" et 1.1/2" - Certifiés ATEX pour usage dans les zones Ex: Ex II 2 GcT6 et Ex II 2 GcT5 - Voir chapitre Sécurité Intrinsèque.

**Cu-Be** Cobre berilio / Beryllium copper / Cuivre beryllium / Kupfer beryllium / Koper beryllium / Rame-berillio / Сплав Медь Бериллий  
**Al-Bron** Aluminio bronce / Aluminium bronze / Alliage aluminium-bronze / Alliage aluminium-bronze / Aluminium brons / Aluminio bronzo / Сплав Алюминий Бронза

Si no encuentra el artículo que necesita, consúltenos en [info@egamaster.com](mailto:info@egamaster.com) o en [www.egamaster.com](http://www.egamaster.com)  
If you can't find the item you look for, please ask us in [info@egamaster.com](mailto:info@egamaster.com) or in [www.egamaster.com](http://www.egamaster.com)  
Si vous ne trouvez pas l'article que vous desirez, consultez-nous à [info@egamaster.com](mailto:info@egamaster.com) ou à [www.egamaster.com](http://www.egamaster.com)

05

**ANTICHISPA  
NON-SPARKING  
ANTIDÉFLAGRANT  
FUNKENFREI  
ANTISCINTILLA  
ANTI-DEFLAGRANTE  
ИСКРОБЕЗОПАСНЫЙ**



1"

■ STANDARD

■ INCH

■ 6 PT.



COD.	MAT.	COD.	MAT.	AF inch	L (mm)	Pt	g
79837		79838		3/4	60		
79849		79850		7/8			650
79851		79852		1	55		700
79853		79854		1.1/16			
78081		78082		1.1/8		750	
79855		79856		1.3/16			
78083		78084		1.1/4	60		
78085		78086		1.5/16		800	
79857		79858		1.3/8			
79859		79860		1.7/16			
78087		78088		1.1/2		850	
78089	Cu-Be	78090	Al-Bron	1.5/8	65	6	950
79865		79866		1.11/16			900
79861		79862		1.3/4			1350
78091		78092		1.13/16	70		
79863		79864		1.7/8		1400	
79867		79868		1.15/16			
78093		78094		2	75		1450
78095		78096		2.1/8			1850
78097		78098		2.3/8	85		2200
78099		78100		2.9/16			2450
78101		78102		2.3/4			2900
78103		78104		2.15/16	90		3150
78105		78106		3.1/8			3550

■ 12 PT.



COD.	MAT.	COD.	MAT.	AF inch	L (mm)	Pt	g
78107		78108		1.1/8	60		800
78109		78110		1.1/4	65		900
78111		78112		1.5/16			
78113		78114		1.1/2	70		1050
78115		78116		1.5/8			
78117		78118		1.13/16	75		1500
78119	Cu-Be	78120	Al-Bron	2	80	12	2050
78121		78122		2.1/8	85		2300
78123		78124		2.3/8	90		2700
78125		78126		2.9/16			2950
78127		78128		2.3/4	95		3150
78129		78130		2.15/16			3350
78131		78132		3.1/8			3550



Llaves de Impacto - Neumáticas e Hidráulicas, Cuadrado 1/2", 3/4", 1" y 1.1/2" - Certificados ATEX para uso en zonas Ex: Ex II 2 GcT6 y Ex II 2 GcT5 - Ver capítulo de Seguridad Intrínseca.  
Impact Wrenches - Pneumatic and Hydraulic, 1/2", 3/4", 1" and 1.1/2" Sq. Drive - ATEX Certified for use in Ex Zones: Ex II 2 GcT6 y Ex II 2 GcT5 - See Intrinsic Safety chapter.  
Douilles à choc - Pneumatiques et Hydrauliques, Carrée de 1/2", 3/4", 1" et 1.1/2" - Certifiés ATEX pour usage dans les zones Ex: Ex II 2 GcT6 et Ex II 2 GcT5 - Voir chapitre Sécurité Intrinsèque.

**Cu-Be** Cobre berilio / Beryllium copper / Cuivre beryllium / Kupfer beryllium / Koper beryllium / Rame-berillio / Сплав Медь Бериллий  
**Al-Bron** Aluminio bronce / Aluminium bronze / Alliage aluminium-bronze / Alliage aluminium-bronze / Aluminium brons / Aluminio bronzo / Сплав Алюминий Бронза

05

**ANTICHISPA  
NON-SPARKING  
ANTIDÉFLAGRANT  
FUNKENFREI  
ANTISCINTILLA  
ANTI-DEFLAGRANTE  
ИСКРОБЕЗОПАСНЫЙ**



1"

■ **SERIE LARGA / LONG SOCKETS / SÉRIE LONGUE / LANGE SERIE / SERIE LUNGA / SERIE LONGA / ВЫСОКАЯ СЕРИЯ**■ **MM**■ **6 PT.**■ **12 PT.**

COD.	MAT.	COD.	MAT.	AF mm	L (mm)	Pt	g
78595		78596		19			900
78597		78598		21			950
78599		78600		22			1000
78601		78602		24			1050
78603		78604		26			1150
78605		78606		27			1250
78607		78608		29	100		1300
78609		78610		30			1350
78611		78612		32			1400
78613		78614		34			1450
78615		78616		35			1500
78617	Cu-Be	78618	Al-Bron	36		6	1400
78619		78620		38			1450
78621		78622		41			1500
78623		78624		46	115		2200
78625		78626		50			2300
78627		78628		52			2650
78629		78630		55	125		2700
78631		78632		58			100
78633		78634		60			3000
78635		78636		65	135		3950
78637		78638		70			4750
78639		78640		75	140		4800
				80			4800

COD.	MAT.	COD.	MAT.	AF mm	L (mm)	Pt	g
78667		78668		19			900
78669		78670		21			950
78671		78672		22			1000
78673		78674		24			1050
78675		78676		26			1150
78677		78678		27			1250
78679		78680		29	100		1300
78681		78682		30			1350
78683		78684		32			1400
78685		78686		34			1450
78687		78688		35			1500
78689	Cu-Be	78690	Al-Bron	36		12	1400
78691		78692		38			1450
78693		78694		41			1500
78695		78696		46	115		2200
78697		78698		50			2300
78699		78700		52			2650
78701		78702		55	125		2700
78703		78704		58			2950
78705		78706		60			3000
78707		78708		65	135		3950
78709		78710		70			4750
78711		78712		75	140		4800
78713		78714		80			4800



Llaves de Impacto - Neumáticas e Hidráulicas, Cuadrado 1/2", 3/4", 1" y 1.1/2" - Certificados ATEX para uso en zonas Ex: Ex II 2 GcT6 y Ex II 2 GcT5 - Ver capítulo de Seguridad Intrínseca.  
Impact Wrenches - Pneumatic and Hydraulic, 1/2", 3/4", 1" and 1.1/2" Sq. Drive - ATEX Certified for use in Ex Zones: Ex II 2 GcT6 y Ex II 2 GcT5 - See Intrinsic Safety chapter.  
Douilles à choc - Pneumatiques et Hydrauliques, Carrée de 1/2", 3/4", 1" et 1.1/2" - Certifiés ATEX pour usage dans les zones Ex: Ex II 2 GcT6 et Ex II 2 GcT5 - Voir chapitre Sécurité Intrinsèque.

**Cu-Be** Cobre berilio / Beryllium copper / Cuivre beryllium / Kupfer beryllium / Koper beryllium / Rame-berillio / Сплав Медь Бериллий  
**Al-Bron** Aluminio bronce / Aluminium bronze / Alliage aluminium-bronze / Alliage aluminium-bronze / Aluminium brons / Aluminio bronzo / Сплав Алюминий Бронза

Si no encuentra el artículo que necesita, consúltenos en [info@egamaster.com](mailto:info@egamaster.com) o en [www.egamaster.com](http://www.egamaster.com)  
If you can't find the item you look for, please ask us in [info@egamaster.com](mailto:info@egamaster.com) or in [www.egamaster.com](http://www.egamaster.com)  
Si vous ne trouvez pas l'article que vous desirez, consultez-nous a [info@egamaster.com](mailto:info@egamaster.com) ou a [www.egamaster.com](http://www.egamaster.com)

**EGAMaster**  
ART IN INNOVATION

05

ANTICHISPA  
NON-SPARKING  
ANTIDÉFLAGRANT  
FUNKENFREI  
ANTISCINTILLA  
ANTI-DEFLAGRANTE  
ИСКРОБЕЗОПАСНЫЙ



1"

■ SERIE LARGA / LONG SOCKETS / SÉRIE LONGUE / LANGE SERIE / SERIE LUNGA / SERIE LONGA / ВЫСОКАЯ СЕРИЯ

■ INCH

■ 6 PT.

■ 12 PT.



COD.	MAT.	COD.	MAT.	AP <sup>+</sup> inch	L (mm)	Pt	g
78641		78642		1.1/8			1150
78643		78644		1.1/4			1300
78645		78646		1.5/16	100		1450
78647		78648		1.1/2			1500
78649		78650		1.5/8			2200
78651		78652		1.13/16	115		2300
78653	Cu-Be	78654	Al-Bron	2		6	2700
78655		78656		2.1/8	125		3000
78657		78658		2.3/8			3950
78659		78660		2.9/16	135		4700
78661		78662		2.3/4			4800
78663		78664		2.15/16	140		
78665		78666		3.1/8			

COD.	MAT.	COD.	MAT.	AP <sup>+</sup> inch	L (mm)	Pt	g
78715		78716		1.1/8			1150
78717		78718		1.1/4			1300
78719		78720		1.5/16	100		1450
78721		78722		1.1/2			1500
78723		78724		1.5/8			2200
78725		78726		1.13/16	115		2300
78727	Cu-Be	78728	Al-Bron	2		12	2700
78729		78730		2.1/8	125		3000
78731		78732		2.3/8			3950
78733		78734		2.9/16	135		4700
78735		78736		2.3/4			4800
78737		78738		2.15/16	140		
78739		78740		3.1/8			



Llaves de Impacto - Neumáticas e Hidráulicas, Cuadrado 1/2", 3/4", 1" y 1.1/2" - Certificados ATEX para uso en zonas Ex: Ex II 2 GcT6 y Ex II 2 GcT5 - Ver capítulo de Seguridad Intrínseca.  
Impact Wrenches - Pneumatic and Hydraulic, 1/2", 3/4", 1" and 1.1/2" Sq. Drive - ATEX Certified for use in Ex Zones: Ex II 2 GcT6 y Ex II 2 GcT5 - See Intrinsic Safety chapter.  
Douilles à choc - Pneumatiques et Hydrauliques, Carrée de 1/2", 3/4", 1" et 1.1/2" - Certifiés ATEX pour usage dans les zones Ex: Ex II 2 GcT6 et Ex II 2 GcT5 - Voir chapitre Sécurité Intrinsèque.

**Cu-Be** Cobre berilio / Beryllium copper / Cuivre beryllium / Kupfer beryllium / Koper beryllium / Rame-berillio / Сплав Медь Бериллий  
**Al-Bron** Aluminio bronce / Aluminium bronze / Alliage aluminium-bronze / Alliage aluminium-bronze / Aluminium brons / Aluminio bronzo / Сплав Алюминий Бронза

05

**ANTICHISPA**  
**NON-SPARKING**  
**ANTIDÉFLAGRANT**  
**FUNKENFREI**  
**ANTISCINTILLA**  
**ANTI-DEFLAGRANTE**  
**ИСКРОБЕЗОПАСНЫЙ**



- 1.1/2"
- STANDARD
- MM
- 6 PT.

- 12 PT.



COD.	MAT.	COD.	MAT.	AF mm	L (mm)	Pt	g
78133		78134		34			
78135		78136		36	80		2200
78137		78138		38			
78139		78140		41			
78141		78142		46	85		2400
78143		78144		48			2450
78145		78146		50			2600
78147		78148		54	90		2650
78149		78150		55			
78151	Cu-Be	78152	Al-Bron	60		6	3050
78153		78154		65	95		3350
78155		78156		70			3800
78157		78158		75	100		4100
78159		78160		80			4800
78161		78162		85	110		5600
78163		78164		90	125		6850
78165		78166		95	130		7650
78167		78168		100	135		8200
78169		78170		105	140		8800

COD.	MAT.	COD.	MAT.	AF mm	L (mm)	Pt	g
78211		78212		34			
78213		78214		36	80		2200
78215		78216		38			
78217		78218		41			
78219		78220		46	85		2400
78221		78222		48			2450
78223		78224		50			2600
78225		78226		54	90		2650
78227		78228		55			
78229	Cu-Be	78230	Al-Bron	60	95	12	3050
78231		78232		65	100		3350
78233		78234		70	105		3800
78235		78236		75	110		4100
78237		78238		80	115		4800
78239		78240		85	120		5600
78241		78242		90	125		6850
78243		78244		95			7650
78245		78246		100	130		8200
78247		78248		105			8800



Llaves de Impacto - Neumáticas e Hidráulicas, Cuadrado 1/2", 3/4", 1" y 1.1/2" - Certificados ATEX para uso en zonas Ex: Ex II 2 GcT6 y Ex II 2 GcT5 - Ver capítulo de Seguridad Intrínseca.  
 Impact Wrenches - Pneumatic and Hydraulic, 1/2", 3/4", 1" and 1.1/2" Sq. Drive - ATEX Certified for use in Ex Zones: Ex II 2 GcT6 y Ex II 2 GcT5 - See Intrinsic Safety chapter.  
 Douilles à choc - Pneumatiques et Hydrauliques, Carrée de 1/2", 3/4", 1" et 1.1/2" - Certifiés ATEX pour usage dans les zones Ex: Ex II 2 GcT6 et Ex II 2 GcT5 - Voir chapitre Sécurité Intrinsèque.

**Cu-Be** Cobre berilio / Beryllium copper / Cuivre beryllium / Kupfer beryllium / Koper beryllium / Rame-berillio / Сплав Медь Бериллий  
**Al-Bron** Aluminio bronce / Aluminium bronze / Alliage aluminium-bronze / Alliage aluminium-bronze / Aluminium brons / Aluminio bronzo / Сплав Аллюминий Бронза

Si no encuentra el artículo que necesita, consúltenos en [info@egamaster.com](mailto:info@egamaster.com) o en [www.egamaster.com](http://www.egamaster.com)  
 If you can't find the item you look for, please ask us in [info@egamaster.com](mailto:info@egamaster.com) or in [www.egamaster.com](http://www.egamaster.com)  
 Si vous ne trouvez pas l'article que vous desirez, consultez-nous a [info@egamaster.com](mailto:info@egamaster.com) ou a [www.egamaster.com](http://www.egamaster.com)

# 05

**ANTICHISPA  
NON-SPARKING  
ANTIDÉFLAGRANT  
FUNKENFREI  
ANTISCINTILLA  
ANTI-DEFLAGRANTE  
ИСКРБЕЗОПАСНЫЙ**



1.1/2"

■ STANDARD

■ INCH

■ 6 PT.



■ 12 PT.



COD.	MAT.	COD.	MAT.	AF inch	L (mm)	Pt	g
78171		78172		1.3/8	80		2200
78173		78174		1.5/8	80		2200
78175		78176		1.13/16	85		2400
78177		78178		2	90		2600
78179		78180		2.1/8	90		2650
78181		78182		2.3/8	95		3050
78183		78184		2.1/2	95		3300
78185		78186		2.9/16	100		3350
78187		78188		2.5/8	100		3400
78189	Cu-Be	78190	Al-Bron	2.3/4	105	6	3800
78191		78192		2.15/16	110		4100
78193		78194		3	110		4200
78195		78196		3.1/8	115		4800
78197		78198		3.3/8	120		5600
78199		78200		3.1/2	125		6700
78201		78202		3.3/4			7650
78203		78204		3.15/16			8200
78205		78206		4	130		8200
78207		78208		4.1/8			8800
78209		78210		4.1/2			10000

COD.	MAT.	COD.	MAT.	AF inch	L (mm)	Pt	g
78249		78250		1.3/8	80		2200
78251		78252		1.5/8	80		2200
78253		78254		1.13/16	85		2400
78255		78256		2	90		2600
78257		78258		2.1/8	90		2650
78259		78260		2.3/8	95		3050
78261		78262		2.1/2	95		3300
78263		78264		2.9/16	100		3350
78265		78266		2.5/8	100		3400
78267	Cu-Be	78268	Al-Bron	2.3/4	105	12	3800
78269		78270		2.15/16	110		4100
78271		78272		3	110		4200
78273		78274		3.1/8	115		4800
78275		78276		3.3/8	120		5600
78277		78278		3.1/2	125		6700
78279		78280		3.3/4			7650
78281		78282		3.15/16			8200
78283		78284		4	130		8200
78285		78286		4.1/8			8800
78287		78288		4.1/2			10000



Llaves de Impacto - Neumáticas e Hidráulicas, Cuadrado 1/2", 3/4", 1" y 1.1/2" - Certificados ATEX para uso en zonas Ex: Ex II 2 GcT6 y Ex II 2 GcT5 - Ver capítulo de Seguridad Intrínseca.  
Impact Wrenches - Pneumatic and Hydraulic, 1/2", 3/4", 1" and 1.1/2" Sq. Drive - ATEX Certified for use in Ex Zones: Ex II 2 GcT6 y Ex II 2 GcT5 - See Intrinsic Safety chapter.  
Douilles à choc - Pneumatiques et Hydrauliques, Carrée de 1/2", 3/4", 1" et 1.1/2" - Certifiés ATEX pour usage dans les zones Ex: Ex II 2 GcT6 et Ex II 2 GcT5 - Voir chapitre Sécurité Intrinsèque.

**Cu-Be** Cobre berilio / Beryllium copper / Cuivre beryllium / Kupfer beryllium / Koper beryllium / Rame-berillio / Сплав Медь Бериллий  
**Al-Bron** Aluminio bronce / Aluminium bronze / Alliage aluminium-bronze / Alliage aluminium-bronze / Aluminium brons / Aluminio bronzo / Сплав Аллюминий Бронза



# 05

**ANTICHISPA  
NON-SPARKING  
ANTIDÉFLAGRANT  
FUNKENFREI  
ANTISCINTILLA  
ANTI-DEFLAGRANTE  
ИСКРОБЕЗОПАСНЫЙ**



- 2.1/2"
- STANDARD
- MM
- 6 PT.



- 12 PT.



COD.	MAT.	COD.	MAT.	AP mm	L (mm)	Pt	g
78289		78290		75	140	6	8400
78291		78292		80			8700
78293		78294		85			8900
78295		78296		90			10250
78297		78298		95			10500
78299	Cu-Be	78300	Al-Bron	100	150	12	11300
78301		78302		105			12200
78303		78304		110			13250
78305		78306		115			14150
78307		78308		120			15050
78309		78310		125	15950		

COD.	MAT.	COD.	MAT.	AP mm	L (mm)	Pt	g
78333		78334		75	140	6	8400
78335		78336		80			8700
78337		78338		85			8900
78339		78340		90			10250
78341		78342		95			10500
78343	Cu-Be	78344	Al-Bron	100	150	12	11300
78345		78346		105			12200
78347		78348		110			13250
78349		78350		115			14150
78351		78352		120			15050
78353		78354		125	15950		

- INCH
- 6 PT.



- 12 PT.



COD.	MAT.	COD.	MAT.	AP inch	L (mm)	Pt	g
78311		78312		2.15/16	140	6	8400
78313		78314		3.1/8			8700
78315		78316		3.3/8			8900
78317		78318		3.1/2			10100
78319		78320		3.3/4			10500
78321	Cu-Be	78322	Al-Bron	3.15/16	150	12	11300
78323		78324		4.1/8			12250
78325		78326		4.5/16			12700
78327		78328		4.1/2			14200
78329		78330		4.3/4			15100
78331		78332		4.15/16	16000		

COD.	MAT.	COD.	MAT.	AP inch	L (mm)	Pt	g
78355		78356		2.15/16	140	6	8400
78357		78358		3.1/8			8700
78359		78360		3.3/8			8900
78361		78362		3.1/2			10100
78363		78364		3.3/4			10500
78365	Cu-Be	78366	Al-Bron	3.15/16	150	12	11300
78367		78368		4.1/8			12250
78369		78370		4.5/16			12700
78371		78372		4.1/2			14200
78373		78374		4.3/4			15100
78375		78376		4.15/16	16000		





Llaves de Impacto - Neumáticas e Hidráulicas, Cuadrado 1/2", 3/4", 1" y 1.1/2" - Certificados ATEX para uso en zonas Ex: Ex II 2 GcT6 y Ex II 2 GcT5 - Ver capítulo de Seguridad Intrínseca.  
Impact Wrenches - Pneumatic and Hydraulic, 1/2", 3/4", 1" and 1.1/2" Sq. Drive - ATEX Certified for use in Ex Zones: Ex II 2 GcT6 y Ex II 2 GcT5 - See Intrinsic Safety chapter.  
Douilles à choc - Pneumatiques et Hydrauliques, Carrée de 1/2", 3/4", 1" et 1.1/2" - Certifiés ATEX pour usage dans les zones Ex: Ex II 2 GcT6 et Ex II 2 GcT5 - Voir chapitre Sécurité Intrinsèque.

**Cu-Be** Cobre berilio / Beryllium copper / Cuivre beryllium / Kupfer beryllium / Koper beryllium / Rame-berillio / Сплав Медь Бериллий  
**Al-Bron** Aluminio bronce / Aluminium bronze / Alliage aluminium-bronze / Alliage aluminium-bronze / Aluminium brons / Aluminio bronzo / Сплав Алюминий Бронза

Si no encuentra el artículo que necesita, consúltenos en [info@egamaster.com](mailto:info@egamaster.com) o en [www.egamaster.com](http://www.egamaster.com)  
If you can't find the item you look for, please ask us in [info@egamaster.com](mailto:info@egamaster.com) or in [www.egamaster.com](http://www.egamaster.com)  
Si vous ne trouvez pas l'article que vous désirez, consultez-nous a [info@egamaster.com](mailto:info@egamaster.com) ou a [www.egamaster.com](http://www.egamaster.com)





**ALARGADERA DE IMPACTO / IMPACT EXTENSION / RALLONGE À CHOC / KRAFTSCHRAUBER-VERLÄNGERUNG / PROLUNGA IMPACT / EXTENSÃO DE IMPACTO / УДАРНЫЙ УДЛИНИТЕЛЬ**

COD.	MAT.	COD.	MAT.		L (mm)	
78377	Cu-Be	78378	Al-Bron	1/2	75	155
78379		78380			125	240
78381		78382		3/4	550	
78383		78384			250	1100
78385		78386			150	2200
78387		78388		1	300	2200





**ADAPTADOR DE IMPACTO / IMPACT ADAPTER / ADAPTATEUR À CHOC / IMPACT STECKCHLÜSSEL EINSATZ / ADATTATORE AD URTO / ADAPTADOR DE IMPACTO / УДАРНЫЙ ПЕРЕХОДНИК**

COD.	MAT.	COD.	MAT.		
76711	Cu-Be	76712	Al-Bron	1/2-3/4	230
76495		76492		3/4-1/2	350
76713		76714		3/4-1	460
76715		76716		1-3/4	700
36202		36207		1-1.1/2	1550
73740		73743		1.1/2-1	3150





**ARTICULACIÓN UNIVERSAL DE IMPACTO / IMPACT UNIVERSAL JOINT / CARDAN UNIVERSAL POUR DOUILLE IMPACTE / KRAFTSCHRAUBER-UNIVERSAL-GELENK / SNODO CARDANICO IMPACT / CARDAN UNIVERSAL DE IMPACTO / УДАРНОЕ УНИВЕРСАЛЬНОЕ СОЕДИНЕНИЕ**

COD.	MAT.	COD.	MAT.		L (mm)	
76518	Cu-Be	76519	Al-Bron	1/2	90	180
76520		76521		3/4	110	320
76522		76525		1	125	950





**PASADOR DE SEGURIDAD / SAFETY PIN / GOUPILLE DE SECURITE / SICHERUNGSSTIFF / COPPIGLIA / PINO DE SEGURANÇA / ФИКСИРУЮЩИЙ ПАЛЕЦ**

COD.	MAT.	COD.	MAT.		L (mm)	Ø x L (mm)	
73711	Cu-Be	73716	Al-Bron	1/2	8-14	4 x 20	2,1
73721		73733			15-50	4 x 25	2,3
73621		73622		3/4	24-30	6 x 30	10
73623		73624			32-50	6 x 40	
73625		73626		1	19-41	6 x 50	15
73627		73628			46-80	6 x 60	



Llaves de Impacto - Neumáticas e Hidráulicas, Cuadrado 1/2", 3/4", 1" y 1.1/2" - Certificados ATEX para uso en zonas Ex: Ex II 2 GcT6 y Ex II 2 GcT5 - Ver capítulo de Seguridad Intrínseca.  
Impact Wrenches - Pneumatic and Hydraulic, 1/2", 3/4", 1" and 1.1/2" Sq. Drive - ATEX Certified for use in Ex Zones: Ex II 2 GcT6 y Ex II 2 GcT5 - See Intrinsic Safety chapter.  
Douilles à choc - Pneumatiques et Hydrauliques, Carrée de 1/2", 3/4", 1" et 1.1/2" - Certifiés ATEX pour usage dans les zones Ex: Ex II 2 GcT6 et Ex II 2 GcT5 - Voir chapitre Sécurité Intrinsèque.



**LLAVES ESPECIALES / SPECIAL WRENCHES / CLÉS SPÉCIALES / SPEZIELL ZANGEN / CHIAVE SPECIALE / CHAVES ESPECIAIS / СПЕЦИАЛЬНЫЕ КЛЮЧИ**
**LLAVE EN "C" / C WRENCH / CLÉ EN C / C SCHLÜSSEL / CHIAVE A C / CHAVE EM C / C-ОБРАЗНЫЙ КЛЮЧ**

COD.	MAT.	COD.	MAT.	L (mm)		
72418	Cu-Be	72419	Al-Bron	450	40	1100



**LLAVE EN "C" DOBLE / DOUBLE C WRENCH / CLÉ EN DOUBLE C / DOPPEL C SCHLÜSSEL / CHIAVE DOPPIA A C / CHAVE EM C DUPLA / ДВОЙНОЙ C-ОБРАЗНЫЙ КЛЮЧ**

COD.	MAT.	COD.	MAT.	L (mm)			
72420	Cu-Be	72421	Al-Bron	200	14,5	18,5	380

**GANCHO GIRADOR DE VÁLVULAS / VALVE WHEEL HOOK / FIXATION GIRATOIRE DE VALVE / VENTILHAKEN / GANCIO GIREVOLE PER VALVOLE / GANCHO DE RODA VÁLVULAS / КЛЮЧ ДЛЯ ОТКРЫТИЯ КЛАПАНОВ**

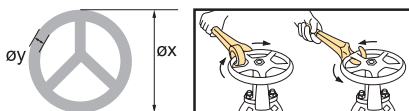
COD.	MAT.	COD.	MAT.	L (mm)		
72422	Cu-Be	72423	Al-Bron	200	30	250
72424		72425		300	32	500
72426		72427		300	35	350
72428		72429		350	40	450
72430		72431		350	45	550
72432		72433		375	48	600
72434		72435		400	50	650
72436		72437		450	55	900
72438		72439		500	60	1150
72440		72441		550	65	1300
72442		72443		600	70	1400
72444		72445		650	75	1600
72446		72447		700	80	1700
72448		72449		750	85	2100
72450		72451		800	90	2200

**LLAVE DE VÁLVULA LARGA / LONG VALVE SPANNER / CLÉ POUR LONGUES VALVES / LANGER VENTIL-SCHLÜSSEL / CHIAVE LARGA PER VALVOLE / CHAVE DE VALVULA LONGA / КЛЮЧ ДЛЯ ОТКРЫТИЯ КЛАПАНОВ ДЛИННЫЙ**

COD.	MAT.	COD.	MAT.	L (mm)	Ø x (inch)	Ø y (mm)	
71432	Cu-Be	71435	Al-Bron	210	3-7	< 36	400
71433		71436		400	8-15	< 48	900
71434		71437		490	16-20	< 60	1400
71441		71445		800			4600

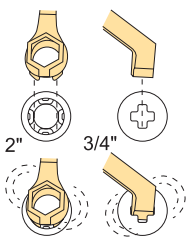

**LLAVE TAPONADORA / BUNG WRENCH / CLÉ OUVRE-BIDONS / PFROPFEN-SCHLÜSSEL / CHIAVE APRIFUSTI / CHAVE ABRE BIDÕES / ОТКРЫВАТЕЛЬ ПРОБОК**

COD.	MAT.	COD.	MAT.	L (mm)	CAP. (inch)	
71446	Cu-Be	71447	Al-Bron	300	2-3/4	800





**Cu-Be** Cobre berilio / Beryllium copper / Cuivre beryllium / Kupfer beryllium / Koper beryllium / Rame-berillio / Сплав Медь Бериллий  
**Al-Bron** Aluminio bronze / Aluminium bronze / Alliage aluminium-bronze / Alliage aluminium-bronze / Aluminium brons / Aluminio bronzo / Сплав Алюминий Бронза

**LLAVE TAPONADORA UNIVERSAL / MUTI-HEAD BUNG WRENCH / CLÉ UNIVERSELLE À BOUCHON / MULTI-HEAD FASSSCHLÜSSEL / CHIAVE A TAPPO UNIVERSALE / CHAVE DE BUJÕES UNIVERSAL / ОТКРЫВАТЕЛЬ ПРОБОК С ГОЛОВКОЙ МУТИ**

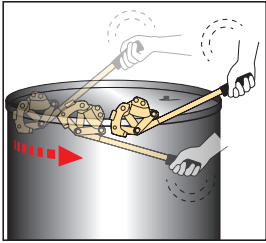
COD.	MAT.	COD.	MAT.	L (mm)	
72452	Cu-Be	72453	Al-Bron	385	1200



**ABREBIDONES / DRUM OPENER / OUVRES BIDONS / FASSÖFFNER / APRITIOIO A TAMBURO / ABRE BIDONS / ОТКРЫВАТЕЛЬ БОЧЕК**

COD.	MAT.	COD.	MAT.	L (mm)		
74282	Cu-Be	74283	Al-Bron	485	3	1



**ABRIDOR DE TONELES DE CARBURO / CARBIDE DRUM OPENER / OUVRE BARIL DE CARBURANT / KARBID-TROMMELÖFFNER / APRIFUSTI PER BARILI DI CARBURO / OUTENSÍLIO PARA ABERTURA DE TAMBORES DE CARBONETO / ИСКРБЕЗОПАСНЫЙ НОЖ ДЛЯ ВСКРЫТИЯ БОЧЕК С КАРБИДОМ**

COD.	MAT.	COD.	MAT.	L (mm)	
72169	Cu-Be	72170	Al-Bron	280	650

**LLAVE DE GANCHO / HOOK SPANNER / CLÉ À ERGOT / ECKZANGE / CHIAVE A SETTORE / CHAVE DE GANCHO / КЛЮЧ КРЮК**

COD.	MAT.	COD.	MAT.	L (mm)	CAP. (mm)	
71392	Cu-Be	71409	Al-Bron	105	12 - 14	40
71393		71410		110	16 - 20	50
71394		71411		130	25 - 28	80
71395		71412		170	30 - 32	100
71396		71413			34 - 36	150
71397		71414		40 - 42	200	
71398		71415		45 - 50	230	
71399		71416		52 - 55	250	
71400		71417		58 - 62	280	
71401		71418		68 - 75	300	
71402		71419		80 - 90	310	
71403		71420		90 - 100	330	
71404		71421		95 - 100	340	
71405		71422		100 - 110	350	
71406		71423		110 - 115		
71407		71424		120 - 130		
71408		71425		135 - 145		

**LLAVE DE GANCHO ARTICULADA / ADJUSTABLE HOOK SPANNER / CLÉ À ERGOT ARTICULEE / ZANGE MIT VERSTELLBARE BACKE / CHIAVE A SETTORE REGOLABILE / CHAVE DE GANCHO ARTICULADA / РУГУЛИРУЕМЫЙ КЛЮЧ КРЮК**

COD.	MAT.	COD.	MAT.	L (mm)	CAP. (mm)	
71426	Cu-Be	71429	Al-Bron	210	32-75	200
71427		71430		280	50-120	500
71428		71431		310	115-170	



**HERRAMIENTA PARA TUBO / PIPE TOOLS / OUTILLAGE TUBE / ROHR WERKZEUGE / FERRAMENTI PER TUBI / FERRAMENTA PARA TUBOS / ТРУБНЫЕ КЛЮЧИ**
**LLAVE HEAVY DUTY / HEAVY DUTY PIPE WRENCH / CLÉ SERRE-TUBES H.D. / EINHAND-ROHRZANGEN / GIRATUBI MODELLO AMERICANO PESANTE / CHAVE HEAVY DUTY / ТРУБНЫЙ КЛЮЧ ДЛЯ ТЯЖЕЛЫХ РАБОТ**

COD.	MAT.	COD.	MAT.	L (inch)	CAP. (inch)	Kg
70121	Cu-Be	71458	Al-Bron	8	1	0,3
70122		71459		10	1.1/2	0,8
70123		71460		12	2	1,3
70124		71461		14	1,7	
70125		71462		18	2.1/2	2,6
70126		71463		24	3	4,5
70127		71464		36	5	9,0
70128		71465		48	6	16

**LLAVE PICO PATO / OFFSET PIPE WRENCH 90° / CLÉ SERRE TUBE 90° / ECKROHRZANGE 90° / GIRATUBO 90° / CHAVE BICO DE PATO / КОЛЕНЧАТЫЙ ТРУБНЫЙ КЛЮЧ**

COD.	MAT.	COD.	MAT.	L (inch)	CAP. (mm)	Kg
36305	Cu-Be	36310	Al-Bron	8	34	0,5
36306		36311		10	48	0,8
36307		36312		12	50	1,1
36308		36313		15	60	1,9
36309		36314		18	76	2,6

**LLAVES SUECAS / SWEDISH PIPE WRENCHES / CLÉS SERRE-TUBES SUEDOISES / ECKROHRZANGE / GIRATUBI MOD. SUEDESE / CHAVES PARA TUBOS SUECAS / ТРУБНЫЕ ШВЕДСКИЕ КЛЮЧИ**
**LLAVE SUECA 45° / SWEDISH PIPE WRENCH 45° / SERRE-TUBES SUEDOISE 45° / ECKROHRZANGE 45° / GIRATUBI MOD. SUEDESE 45° / CHAVE SUECA 45° / ШВЕДСКИЙ КЛЮЧ S 45°**

COD.	MAT.	COD.	MAT.	CAP. (inch)	L (mm)	Kg
70129	Cu-Be	71466	Al-Bron	1.1/2	420	1,4
70130		71467		550	2,5	
79821		79824		2	700	4,5

**LLAVE SUECA 90° / SWEDISH PIPE WRENCH 90° / CLÉ SERRE-TUBES SUEDOISE 90° / ECKROHRZANGE 90° / GIRATUBI MOD. SUEDESE 90° / CHAVE SUECA 90° / ТРУБНЫЙ ШВЕДСКИЙ КЛЮЧ 90°**

COD.	MAT.	COD.	MAT.	CAP. (inch)	Kg
79822	Cu-Be	79825	Al-Bron	2	2,5
79823		79826		3	4,5

**LLAVE SPUD / SPUD PIPE WRENCH / CLÉ SPUD / VERSTELLBARE ROHRZANGE / GIRATUBI MODELLO SPUD / CHAVE PARA TUBO SPUD / ТРУБНЫЙ КЛЮЧ С ПАРАЛЛЕЛЬНЫМИ ГУБКАМИ**

COD.	MAT.	COD.	MAT.	L (inch)	CAP. (mm)	Kg
71822	Cu-Be	71823	Al-Bron	12	58	1,2

**LLAVE DE CORREA / STRAP WRENCH / CLÉ À SANGLE / GURTRÖHRZANGE / GIRATUBI A NASTRO / CHAVE DE CORREIA / РЕМЕШКОВЫЙ КЛЮЧ**

COD.	MAT.	COD.	MAT.	L (mm)	CAP. (inch)	g
73906	Cu-Be	73907	Al-Bron	300	3	800



**LLAVE DE CADENA / CHAIN PIPE WRENCH / CLÉ À CHAÎNE / KETTEN-ROHRZANGE / GIRATUBI A CATENA / CHAVE CORRENTE / ЦЕПНОЙ КЛЮЧ**

COD.	MAT.	COD.	MAT.	L (mm)	CAP. (inch)	Kg
72976	Cu-Be	72977	Al-Bron	600	4	3,8
72978		72979			6	4,2
72980		72981		900	8	8,5
72982		72983			12	9,5



COD.	MAT.	COD.	MAT.	L (mm)	CAP. (inch)	Kg
70131	Cu-Be	71468	Al-Bron	600	2	2,2
70132		71469			4	2,8
70133		71470			6	3,5

**CORTATUBOS / PIPE CUTTER / COUPE-TUBES / ROHRABSCHNEIDER / TAGLIATUBI / CORTA TUBOS / ТРУБОРЕЗ ДЛЯ СТАЛИ**

COD.	MAT.	COD.	MAT.	L (mm)	CAP. (inch)	H (mm)	Kg
70134	Cu-Be	71471	Al-Bron	380	2	60	2,4



COD.	MAT.	COD.	MAT.	L (mm)	CAP. (inch)	H (mm)	Kg
74327	Cu-Be	74330	Al-Bron	740	4-6	280	12,3
74340		74343		860	8-12	465	21

**TORNILLO DE BANCO PARALELO / PARALLEL BENCH VICE / ÉTAU À MORS PARALLELES / PARALLELSCHRAUBSTÖCKE / MORSA DA BANCO PARALLELA / TORNO DE BANCADA PARALELO / СЛЕСАРНЫЕ ТИСКИ**

COD.	MAT.	COD.	MAT.	inch	mm	Kg
70482	Cu-Be	71636	Al-Bron	4	100	15
70483		71637		5	140	18
70486		72191		6	150	27
70487		72192		7	170	28

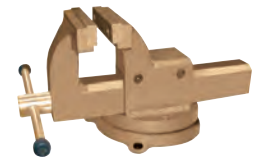
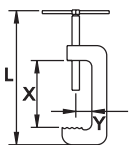
**PRENSA / CLAMP / PRESSE / KNEBEL / MORSETTO / PRENSA / СТРУБЦИНА**





COD.	MAT.	COD.	MAT.	L (mm)	X	Y	g
72478	Cu-Be	72479	Al-Bron	210	60		1200
72480		72481		250	80	36	1400
72482		72483		290	100		1600
72484		72485		340	150	50	2000
73418		73425		400	250	150	4900

**SARGENTOS / CLAMPS / SERRE-JOINTS / ZWINGEN / MORSETTI SERRAGIUNTI / GRAMPOS / СТРУБЦИНЫ**
**MOD. F**





COD.	MAT.	COD.	MAT.	CAP. (mm)	g
74250	Cu-Be	74251	Al-Bron	400	2200







**■ DESTORNILLADORES / SCREWDRIVERS / TOURNEVIS / SCHRAUBENDREHER / CACCIAVITI / CHAVES DE FENDA / ОТВЕРТКИ**
**■ MECÁNICO / SLOTTED / MECANICIEN / WERSTATT / PER MECCANICI / MECÂNICO / ПЛОСКАЯ**

COD.	MAT.	COD.	MAT.				
72258	Cu-Be	72279	Al-Bron	50	3	80	35
72259		4,5			43		
72260		3			35		
72261		75		4	45		
72262				5	70		
72263				4	82	45	
72264				5	103	75	
72265		100		5	103	85	
72266				6	100		
72267				7	110		
72268		150		7	125		
72269				8	140		
72270		200		8	165		
72271		250		9	185		
72272		200		10	260		
72273		300		10	230		
72274		250		11	240		
72275		300		11	290		
72276		350		11	320		







COD.	MAT.	COD.	MAT.				
72277	Cu-Be	72298	Al-Bron	400	12	150	400
72278		450		13	480		

**■ ELECTRICISTA / ELECTRICIAN / ELECTRICIEN / ELEKTRIKER / PER ELETRICISTI / ELETTRICISTA / ЭЛЕКТРИЧЕСКАЯ**





COD.	MAT.	COD.	MAT.				
74756	Cu-Be	74757	Al-Bron	50	2,5	84	36
71581		3			75	50	
76480		100		3	84	70	
71582				4	84	80	
76482				5	105	150	
71583				7	115	200	
72306		100		75	100		
76484		150		5	105	150	
72307		200		75	200		
74758		100		5,5	115	100	
71584				6	95	100	
75268		150		7	115	200	
71585				8	105	200	
71586				10	105	300	
71587		300		10	300		

**■ PHILIPS**





COD.	MAT.	COD.	MAT.				
72909	Cu-Be	72910	Al-Bron	PH-0	60	75	40
71595		80			70	50	
76486		PH-1		100	105	70	
71596				95	70		
76488		PH-2		125	115	100	
76489				115	100		







**Cu-Be** Cobre berilio / Beryllium copper / Cuivre beryllium / Kupfer beryllium / Koper beryllium / Rame-berillio / Сплав Медь Бериллий  
**Al-Bron** Aluminio bronze / Aluminium bronze / Alliage aluminium-bronze / Alliage aluminium-bronze / Aluminium brons / Aluminio bronzo / Сплав Алюминий Бронза

COD.	MAT.	COD.	MAT.				
71597	Cu-Be	71601	Al-Bron	PH-3	150	95	80
71598		71602		PH-4	200	105	100





**POZIDRIV®\***

COD.	MAT.	COD.	MAT.				
74336	Cu-Be	74337	Al-Bron	PZ-0	50	82	35
74347		74348		PZ-1	75	80	40
72247		72246		PZ-2	100	80	80
72249		72248		PZ-3	150	112	135
74365		74366		PZ-4	200	210	210





**TORX®\***

COD.	MAT.	COD.	MAT.				
35714	Cu-Be	35715	Al-Bron	T 10	75	98	67
35716		35717		T 15			71
35718		35719		T 20			98
74367		74368		T 25	125	103	
35720		35721		T 27	150	108	108
35722		35723		T 30			
35724		35725		T 40	200	120	160
35726		35727		T 45	250	180	180

**TAMPER TORX**

COD.	MAT.	COD.	MAT.				
35700	Cu-Be	35701	Al-Bron	TT 10	75	98	67
35702		35703		TT 15			71
35704		35705		TT 20			98
74349		74350		TT 25	125	103	
35706		35707		TT 27	150	108	108
35708		35709		TT 30			
35710		35711		TT 40	200	120	160
35712		35713		TT 45	250	180	180

**DE VASO HEXAGONAL / HEXAGONAL SOCKET / DOUILLE HEXAGONALE / SCHRAUBENDREHER EINSATZ HEX / BUSSOLE ESAGONALI / CHAVE DE CAIXA HEXAGONAL / ШЕСТИГРАННАЯ ГОЛОВКА**

COD.	MAT.	COD.	MAT.				
73879	Cu-Be	73880	Al-Bron	6	90	100	85
73878		73891		7			95
73881		73882		8			100
73883		73884		10	110	110	140
73885		73886		13			180
73887		73888		16	120	120	220
73889		73890		17			230



**Cu-Be** Cobre berilio / Beryllium copper / Cuivre beryllium / Kupfer beryllium / Koper beryllium / Rame-berillio / Сплав Медь Бериллий

**Al-Bron** Aluminio bronce / Aluminium bronze / Alliage aluminium-bronze / Alliage aluminium-bronze / Aluminium brons / Aluminium bronzo / Сплав Алюминий Бронза

\*Para tornillos POZIDRIV® (Marca registrada por European Ind. Serv. Ltd.) / \*For screws POZIDRIV® (European Ind. Serv. Ltd. registered trademark) / \*Pour vis POZIDRIV® (Marque enregistrée par European Ind. Serv. Ltd.)

\*Para tornillos TORX® (Marca registrada por Acument Intellectual Properties, LLC, Troy, Mich., US) / \*For screws TORX® (Acument Intellectual Properties, LLC, Troy, Mich., US registered trademark) / \*Pour vis TORX® (Marque enregistrée par Acument Intellectual Properties, LLC, Troy, Mich., US)





05



**ANTICHISPA  
NON-SPARKING  
ANTIDÉFLAGRANT  
FUNKENFREI  
ANTISCINTILLA  
ANTI-DEFLAGRANTE  
ИСКРБЕЗОПАСНЫЙ**



## ■ SET



## ■ 6 PCS.



COD.	MAT.	PCS.		
<b>76465</b>	Cu-Be	6	3 x 50 (72258), 4 x 100 (72263), 5 x 100 (72264), 8 x 150 (72269)	PH-1 (71595), PH-2 (71596)
<b>76466</b>	Al-Bron			

COD.	MAT.	PCS.		
<b>76467</b>	Cu-Be	6	3 x 50 (71581), 4 x 100 (71582), 5 x 100 (72306), 8 x 150 (71585)	PH-1 (71595), PH-2 (71596)
<b>76468</b>	Al-Bron			





## ■ 8 PCS.

COD.	MAT.	PCS.			
<b>76469</b>	Cu-Be	8	3 x 50 (72258), 4 x 100 (72263), 5 x 100 (72264), 6 x 100 (72265)	PH-1 (71595), PH-2 (71596)	PZ-1 (74347), PZ-2 (72247)
<b>76470</b>	Al-Bron				

COD.	MAT.	PCS.			
<b>76471</b>	Cu-Be	8	3 x 50 (71581), 4 x 100 (71582), 5 x 100 (72306), 6 x 100 (71584)	PH-1 (71595), PH-2 (71596)	PZ-1 (74347), PZ-2 (72247)
<b>76472</b>	Al-Bron				

**DESTORNILLADOR ACODADO / OFFSET SCREWDRIVER / TOURNEVIS CONTRE COUDÉ / WINKELSCHRAUBENDREHER / CACCIAVITE A SQUADRA / CHAVE DE PARAFUSOS ANGULAR / КОЛЕНЧАТАЯ ОТВЕРТКА**

COD.	MAT.	COD.	MAT.	L (mm)		
<b>74301</b>	Cu-Be	<b>74302</b>	Al-Bron	125	4	100
<b>72462</b>		<b>72463</b>		72	6	25
<b>72464</b>		<b>72465</b>		125	8	50
<b>72466</b>		<b>72467</b>		195	10	125



**Cu-Be** Cobre berilio / Beryllium copper / Cuivre beryllium / Kupfer beryllium / Koper beryllium / Rame-berillio / Сплав Медь Бериллий  
**Al-Bron** Aluminio bronce / Aluminium bronze / Alliage aluminium-bronze / Alliage aluminium-bronze / Aluminium brons / Aluminio bronzo / Сплав Алюминий Бронза

Si no encuentra el artículo que necesita, consúltenos en [info@egamaster.com](mailto:info@egamaster.com) o en [www.egamaster.com](http://www.egamaster.com)  
 If you can't find the item you look for, please ask us in [info@egamaster.com](mailto:info@egamaster.com) or in [www.egamaster.com](http://www.egamaster.com)  
 Si vous ne trouvez pas l'article que vous désirez, consultez-nous à [info@egamaster.com](mailto:info@egamaster.com) ou à [www.egamaster.com](http://www.egamaster.com)

**EGAMaster**  
ART IN INNOVATION

05

ANTICHISPA  
NON-SPARKING  
ANTIDÉFLAGRANT  
FUNKENFREI  
ANTISCINTILLA  
ANTI-DEFLAGRANTE  
ИСКРОБЕЗОПАСНЫЙ



■ PALAS Y RASTRILLOS / SHOVELS AND RAKES / PELLE ET RACLETTES / SCHAUFEL UND RECHEN / PALE E RASTRELLI / PÁS E ANSINHOS / ЛОПАТЫ И ГРАБЛИ

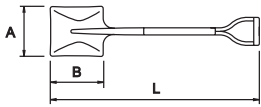

COD.	MAT.	COD.	MAT.	L (mm)	A (mm)	B (mm)	
71615	Cu-Be	71616	Al-Bron	1350	240	290	1500



■ PALA PUNTA / ROUND POINT SHOVEL / PELLE EN POINTE / SCHWANENHALSSCHAUFEL / PALA A PUNTA TONDA / PA DE BICO / САДОВАЯ ЛОПАТА

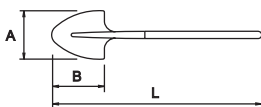

COD.	MAT.	COD.	MAT.	L (mm)	A (mm)	B (mm)	
71617	Cu-Be	71618	Al-Bron	1350	240	290	1500



■ PALA DE CAVAR / EDGING SPADE / PELLE BÊCHE / SCHAUFEL VIERECKING / PALA PER SCAVARE / PA DE VALAR / СОВКОВАЯ ЛОПАТА

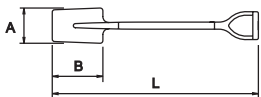

COD.	MAT.	COD.	MAT.	L (mm)	A (mm)	B (mm)	
71619	Cu-Be	71620	Al-Bron	1120	180	280	1500



■ PALETA / BRICKLAYER / SPATULE / MAUERKELLE / PALETTA / COLHER / МАСТЕРОК

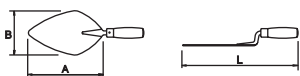

COD.	MAT.	COD.	MAT.	L (mm)	A (mm)	B (mm)	
73772	Cu-Be	73773	Al-Bron	335	210	130	650



■ AZADA / HOE / PIOCHE / HAUE / ZAPPA / ENXADA / МОТЫГА

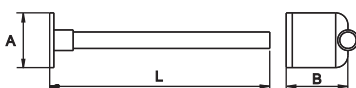

COD.	MAT.	COD.	MAT.	L (mm)	A (mm)	B (mm)	
74253	Cu-Be	74254	Al-Bron	900	130	130	1200
74255		200			200	1800	



■ HORQUILLA 3 PUNTAS / 3 PRONG FORK / FOURCHE À TROIS POINTES / SPATENGABEL MIT 2 ZINKEN / FORCA A 3 PUNTE / FORQUILHA 3 PONTAS / 3-ЗУБЬЕВЫЕ ВИЛЫ

COD.	MAT.	COD.	MAT.	L x W x H (mm)	
74231	Cu-Be	74232	Al-Bron	1025 x 200 x 185	1500



**Cu-Be** Cobre berilio / Beryllium copper / Cuivre beryllium / Kupfer beryllium / Koper beryllium / Rame-berillio / Сплав Медь Бериллий  
**Al-Bron** Aluminio bronze / Aluminium bronze / Alliage aluminium-bronze / Alliage aluminium-bronze / Aluminium brons / Aluminio bronzo / Сплав Алюминий Бронза

05

**ANTICHISPA  
NON-SPARKING  
ANTIDÉFLAGRANT  
FUNKENFREI  
ANTISCINTILLA  
ANTI-DEFLAGRANTE  
ИСКРОБЕЗОПАСНЫЙ**



**HORQUILLA 4 PUNTAS / 4 PRONG FORK / FOURCHE À QUATRE POINTES / SPATENGABEL MIT 4 ZINKEN / FORCA A 4 PUNTE / FORQUILHA 4 PONTAS / 4-ЗУБЬЕВЫЕ ВИЛЫ**

COD.	MAT.	COD.	MAT.	L x W (mm)	
74234	Cu-Be	74235	Al-Bron	1225 x 200	2000



**RASTRILLO LIMPIADOR DE OXIDO / RUST CLEANING RAKE / RÂTEAU POUR NETTOYAGE DE L'OXIDE / RECHEN F / ROST RASTRELLO PER PULIRE L'OSSIDO / ANSINHO LIMPADOR DE OXIDO / СКРЕБОК ДЛЯ УДАЛЕНИЯ РЖАВЧИНЫ**

COD.	MAT.	COD.	MAT.	L x W x H (mm)	
74237	Cu-Be	74238	Al-Bron	350 x 100 x 100	900



**RASTRILLO / RAKE / RATEAU / RECHEN / RASTRELLO / ANSINHO / СКРЕБОК**

COD.	MAT.	COD.	MAT.	L x W x H (mm)	
74258	Cu-Be	74259	Al-Bron	1270 x 350 x 100	1300
74260	Cu-Be	74261	Al-Bron	1270 x 450 x 120	1500



**CORTE / CUTTING / OUTILS COUPANTS / SCHNEIDWERKZEUG / ARCHETTI / CORTE / РЕЗКА**

**CORTAVARILLAS / BOLT CUTTERS / COUPE-BOULONS / BOLZENSCHNEIDER / TAGLIABULLONI / CORTA VARAO / АРМАТУРНЫЕ НОЖНИЦЫ**

COD.	MAT.	COD.	MAT.	L (inch)		
73415	Cu-Be	73423	Al-Bron	24	50 kg/mm <sup>2</sup> 100 kg/mm <sup>2</sup>	3000
35760	Cu-Be	35761	Al-Bron	24		



**CIZALLA DE PASO LIBRE A LA DERECHA / RIGTH CUT NIPPER SHEAR / CISAILLE COUPE DROITE / SCHNEIDSCHERE RECHTS / CESAIO TAGLIO DESTRO / TESOURA DE PASSAGEM LIVRE A DIREITA / НОЖНИЦЫ ПРАВОЙ РЕЗКИ**

COD.	MAT.	COD.	MAT.	L (mm)	
70528	Cu-Be	70545	Al-Bron	275	600



**TIJERAS / TIN SNIPS / CISAILLES / BLECHSCHERE / FORBICI / TESOURAS / НОЖНИЦЫ ДЛЯ ЖЕСТИ**

COD.	MAT.	COD.	MAT.	L (mm)	
70529	Cu-Be	70546	Al-Bron	225	300



COD.	MAT.	COD.	MAT.	L (mm)	
72460	Cu-Be	72461	Al-Bron	150	90



COD.	MAT.	COD.	MAT.	L (mm)	
73892	Cu-Be	73893	Al-Bron	290	220
73894	Cu-Be	73895	Al-Bron	360	850



**Cu-Be** Cobre berilio / Beryllium copper / Cuivre beryllium / Kupfer beryllium / Koper beryllium / Rame-berillio / Сплав Медь Бериллий  
**Al-Bron** Aluminio bronze / Aluminium bronze / Alliage aluminium-bronze / Alliage aluminium-bronze / Aluminium brons / Aluminio bronzo / Сплав Алюминий Бронза

Si no encuentra el artículo que necesita, consúltenos en [info@egamaster.com](mailto:info@egamaster.com) o en [www.egamaster.com](http://www.egamaster.com)  
 If you can't find the item you look for, please ask us in [info@egamaster.com](mailto:info@egamaster.com) or in [www.egamaster.com](http://www.egamaster.com)  
 Si vous ne trouvez pas l'article que vous desirez, consultez-nous a [info@egamaster.com](mailto:info@egamaster.com) ou a [www.egamaster.com](http://www.egamaster.com)

**EGAMaster**  
ART IN INNOVATION

TIJERAS DE HOJALATERO / TIN SNIPS / CISEAUX DE TOLIER / BLECHSCHEREN / CESCOIA PER LATTONNIERI / TESOURAS DE CHAPA / НОЖНИЦЫ ПО ЖЕСТИ

COD.	MAT.	COD.	MAT.	L (mm)	g
72458	Cu-Be	72459	Al-Bron	300	450



ARCO DE SIERRA / HACK SAW / MONTURE DE SCIE À METAUX / METALLSÄGEN GEBOGEN / ARCHETTI / ARCO DE SERRA / НОЖОВКА

COD.	MAT.	COD.	MAT.	L (mm)	g
72220	Cu-Be	72221	Al-Bron	500	600



HOJAS PARA ARCO DE SIERRA / HACKSAW BLADES / LAMES DE SCIES / METALLSÄGEBLÄTTER / LAME PER ARCHETTI / FOLHA DE SERRA / ПОЛОТНА ДЛЯ НОЖОВКИ

COD.	MAT.	L (mm)	TPI	g
72223	Cu-Be	300	18	35



SIERRA MANUAL / HANDSAW / SCIE À MAIN / HANDSÄGE / ARCO MANUALE / SERROTE MANUAL / НОЖОВКА

COD.	MAT.	COD.	MAT.	L (mm)	g
72468	Cu-Be	72469	Al-Bron	370	125



SERRUCHO / HANDSAW / SCIE ÉGOÏNE / HANDSÄGE / SEGHETTO / SERROTE / НОЖОВКА

COD.	MAT.	COD.	MAT.	L (mm)	g
74228	Cu-Be	74229	Al-Bron	700	550



CUCHILLOS / KNIVES / COUTEAUX / MESSER / COLTELLI / FACAS / НОЖИ

COD.	MAT.	COD.	MAT.	L (mm)	g
71611	Cu-Be	71612	Al-Bron	30 x 200	70



COD.	MAT.	COD.	MAT.	L (mm)	g
71613	Cu-Be	71614	Al-Bron	250	90





NAVAJA DE ELECTRICISTA / ELECTRICIAN KNIFE / COUTEAU ELECTRICIEN / ELEKTRIKER MESSER / COLTELLO PER ELETTRICISTI / NAVALHA DE ELETRICISTA / НОЖИ ДЛЯ ЭЛЕКТРИКА

COD.	MAT.	COD.	MAT.	L (mm)	g
73741	Cu-Be	73742	Al-Bron	61 x 113	180



■ **BROCAS / TWIST DRILL / MÈCHES / BOHRER / PUNTE PER TRAPANO / BROCAS / СВЕРЛО**

COD.	MAT.		L (mm)	
73632	Cu-Be	6	100	25
73633		7	120	35
73634		8	140	55
73635		9	160	80
73636		10	180	110
73637		11	200	150
73638		12	220	200
73639		13	240	250
73640		14	260	320
73641		15	280	400
73642		16	300	470
73643		17	320	540
73644		18	320	650
73645		19	320	720
73646		20	330	820





**CARACTERÍSTICAS / FEATURES / CARACTÉRISTIQUES**

Para materiales con dureza < 20HRC / For materials with hardness < 20HRC / Pour les matériaux de dureté < 20HRC

■ **LIMAS / FILES / LIMES / FEILEN / LIMA / LIMAS / НАПИЛЬНИКИ**

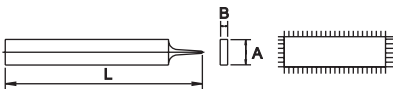
■ **LIMA PLANA / HAND FILE / LIME PLATE / HANDFEILE / LIMA PIATTA / LIMA PARALELA / РУЧНОЙ НАПИЛЬНИК**



COD.	MAT.	L (mm)	A (mm)	B (mm)	
71607	Cu-Be	200	20	6	350
71608		300	31	8	750

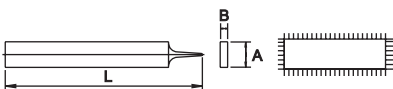

COD.	MAT.	L (mm)	A (mm)	B (mm)	
72237	Cu-Be	500	41	12	1800



■ **LIMAS MEDIA CAÑA / HALF ROUND FILES / LIMES DEMI-RONDES / HALBRUND FEILEN / LIMA MEZZATONDA / LIMAS MEIA CANA / ПОЛУКОУГЛЫЙ НАПИЛЬНИК**

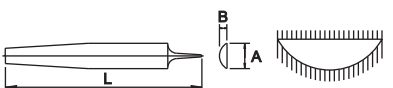

COD.	MAT.	L (mm)	A (mm)	B (mm)	
71603	Cu-Be	200	19	10	450



■ **LIMA REDONDA / ROUND FILE / LIME RONDE / RUND FEILE / LIME TONDE / LIMATÃO REDONDO / КРУГЛЫЙ НАПИЛЬНИК**



COD.	MAT.	L (mm)	Ø A (mm)	
71605	Cu-Be	200	9	450



**Cu-Be** Cobre berilio / Beryllium copper / Cuivre beryllium / Kupfer beryllium / Koper beryllium / Rame-berillio / Сплав Медь Бериллий

■ MISCELÁNEA / MISCELLANEOUS / DIVERS / VERSCHIEDENE / MISCELLANEA / MISTURA / РАЗНОЕ

■ CINCEL / FLAT CHISEL / CISEAU / MAURERMEISSEL / SCALPELLI / ESCOPRO / ПЛОСКОЕ ЗУБИЛО

COD.	MAT.	COD.	MAT.	L (mm)	g
70447	Cu-Be	71509	Al-Bron	150 x 22	300
70448		71510		200 x 22	400
79829		79832		225 x 20	320
70449		71511		250 x 24	600
70450		71512		300 x 25	800
79827		79830		305 x 13	210
70451		71513		400 x 27	1000
79828		79831		460 x 26	1250



■ CINCEN EN PUNTA / CROSS CUTTING CHISEL / BURIN / DURCHSCHLAGMEISSEL / SCALPELLI A PUNTA / PONTEIRO / ВЫРУБНОЕ ЗУБИЛО

COD.	MAT.	COD.	MAT.	L (mm)	g
73778	Cu-Be	73779	Al-Bron	140	270
73780		73781		200	450
73782		73783		300	800



■ CORTAFRÍOS CILÍNDRICO / CYLINDRICAL COLD CHISEL / BÉDANE CYLINDRIQUE / ZYLINDRISCHE MEISSEL / SCALPELLO CILINDRICO TAGLIO A FREDDO / ESCOPRO CILINDRICO / ЦИЛИНДРИЧЕСКОЕ ЗУБИЛО

COD.	MAT.	COD.	MAT.	L (mm)	O.D. mm	g
73788	Cu-Be	73789	Al-Bron	14 x 160	14	175
73790		73791		16 x 160	16	230
73792		73793		18 x 160	18	280
73794		73795		18 x 200	18	370
73796		73797		20 x 200	20	470
73798		73799		24 x 250	24	800
73800		73801		24 x 300	24	1000
73802		73803		25 x 300	25	1250
73804		73805		25 x 400	25	1400
73806		73807		25 x 500	25	1800
73808		73809		30 x 500	30	2650



■ CORTAFRÍOS HEXAGONAL / HEXAGONAL COLD CHISEL / BÉDANE HÉXAGONALE / HEX MEIBEL / SCALPELLO ESAGONALE TAGLIO A FREDDO / ESCOPRO HEXAGONAL / ШЕСТИГРАННОЕ ЗУБИЛО

COD.	MAT.	COD.	MAT.	L (mm)	AF mm	g
73811	Cu-Be	73812	Al-Bron	12 x 150	10	100
73813		73814		16 x 200	14	250
73815		73816		18 x 160	16	260
73817		73818		16 x 250	14	320
73819		73820		19 x 300	17	700
73821		73822		19 x 350	17	900
73823		73824		24 x 600	22	1800
73825		73826		28 x 300	25	1100
73827		73828		35 x 500	30	2700



■ GRANETE / CENTRE PUNCH / POINTEAU / KÖRNER / PUNTE DA CENTRO / PUNÇÃO DE BICO / МЕТЧИК

COD.	MAT.	COD.	MAT.	L (mm)	g
71514	Cu-Be	71516	Al-Bron	100	60
71515		71517		150	80



05

**ANTICHISPA  
NON-SPARKING  
ANTIDÉFLAGRANT  
FUNKENFREI  
ANTISCINTILLA  
ANTI-DEFLAGRANTE  
ИСКРОБЕЗОПАСНЫЙ**



■ **BOTADORES CÓNICOS / TAPER PUNCHES / CHASSE CLOU / KÖRNER / PUNZONE CONICO / PUNÇÕES CÓNICOS / КОНИЧЕСКИЕ ПРОБОЙНИКИ**

■ **MM**

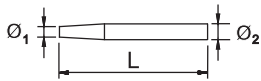

COD.	MAT.	COD.	MAT.	L (mm)	Ø 1 (mm)	Ø 2 (mm)			
70426		71472		150	2	10	60		
70427		71473			3				
70428		71474			4				
70429		71475			5				
70430		71476			6				
70431		71477			7				
70432		71478			8	12	70		
70433		71479			9				
70434		71480			10				
70435		71481			11				
70436	Cu-Be	71482	Al-Bron	200	12	16	200		
70437		71483			13				
70438		71484			14	18	300		
70439		71485			15				
70440		71486			16			20	400
70441		71487			17				
70442		71488			18	22	500		
70443		71489			19				
70444		71490			20			24	800
70445		71491			21				
70446	71492	22	250	26	900				



■ **INCH**

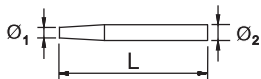

COD.	MAT.	COD.	MAT.	L (mm)	Ø 1 (inch)	Ø 2 (inch)		
73583		73572		150	1/8"	3/8"	950	
73584		73573			3/16"			
73585		73574			1/4"			
73586		73575			5/16"	7/16"		
73587	Cu-Be	73576	Al-Bron		200	3/8"		17/32"
73588		73577				1/2"		19/32"
73589		73578		5/8"		3/4"		
73590		73579		250		3/4"	15/16"	1000
73591		73580				7/8"	1"	



■ **BOTADORES CILÍNDRICOS / PIN PUNCHES / CHASSES GOUPILLES / DURCHSCHLÄGER / PUNZONE CILINDRICO / PUNÇÕES CILÍNDRICOS / ПРОБОЙНИКИ**

COD.	MAT.	COD.	MAT.	L (mm)		
71518		71527		110	1,4	5
71519		71528			1,8	10
71520		71529			2,4	
71521		71530			2,8	
71522	Cu-Be	71531	Al-Bron		120	3
71523		71532		4		38
71524		71533		5		65
71525		71534		6		95
71526		71535		8		175



**Cu-Be** Cobre berilio / Beryllium copper / Cuivre beryllium / Kupfer beryllium / Koper beryllium / Rame-berillio / Сплав Медь Бериллий  
**Al-Bron** Aluminio bronze / Aluminium bronze / Alliage aluminium-bronze / Alliage aluminium-bronze / Aluminium brons / Aluminio bronzo / Сплав Алюминий Бронза

Si no encuentra el artículo que necesita, consúltenos en [info@egamaster.com](mailto:info@egamaster.com) o en [www.egamaster.com](http://www.egamaster.com)  
 If you can't find the item you look for, please ask us in [info@egamaster.com](mailto:info@egamaster.com) or in [www.egamaster.com](http://www.egamaster.com)  
 Si vous ne trouvez pas l'article que vous desirez, consultez-nous a [info@egamaster.com](mailto:info@egamaster.com) ou a [www.egamaster.com](http://www.egamaster.com)

**EGAMaster**  
ART IN INNOVATION

**PUNTERO / DIAMOND POINT CHISEL / BURIN / KÖRNER / PUNTE / PUNÇAO / ПРОБОЙНИК С АЛМАЗНЫМ НАКОНЕЧНИКОМ**

COD.	MAT.	COD.	MAT.	L (mm)	AF mm	g
71544	Cu-Be	71548	Al-Bron	200	16	300
71545		71549		250	17	500
71546		71550		300	19	600
71547		71551		400	20	1000

**PUNTERO ESPECIAL / CAULKING TOOL / BURIN SPECIAL / KÖRNER LANG / PUNTE SPECIALI / PUNÇAO ESPECIAL / МОНТИРОВКА**

COD.	MAT.	COD.	MAT.	L (mm)	AF mm	Kg
71552	Cu-Be	71557	Al-Bron	1000	32	6,5
71553		71558		1200	36	9,5
71554		71559		1500		13
71555		71560		1000	50	16
71556	71561	1200	18			

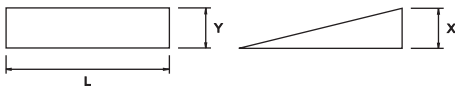
**CUÑA / WEDGE / COIN / KEIL / CUNEO / CUNHA / КЛИН**

COD.	MAT.	COD.	MAT.	L (mm)	Y	X	g
78967	Cu-Be	78968	Al-Bron	80	13	6-0	50
70452		71493		100	50	10-0	200
70453		71494		135		18-0	500
70454		71495		150		25	8-0
70455		71496			13-0	200	
70456		71497			40	8-0	400
70457		71498			50	13-0	300
70458		71499		180	13	6-0	700
70459		71500			32	13-0	
70460		71501		200	50	19-0	2500
70461		71502			20	30-0	
70377		36216			30	20-0	
70462		71503			30	30-0	
70463		71504			40	40-0	
70464		71505			50	12-0	
70465		71506			230	20-0	
70466		71507			250	30-0	
70467		71508		300	40-0		

**PALANCA / PINCHBAR / PINCE À TALON / BRECHSTANGE / LEVA / AVALANCA / МОНТИРОВКА**

COD.	MAT.	COD.	MAT.	L (mm)	Kg
70468	Cu-Be	71570	Al-Bron	19 x 500	1,3
70469		71571		23 x 800	2,9
70470		71572		28 x 1000	4,5



COD.	MAT.	COD.	MAT.	L (mm)	O.D. mm	Kg
73833	Cu-Be	73834	Al-Bron	500	15	0,7
73835		73836			19	1,0
73837		73838			20	1,2
73839		73840			25	1,8
73841		73842		600	30	2,7
73843		73844			25	2,2
73845		73846			30	3,3





05

**ANTICHISPA  
NON-SPARKING  
ANTIDÉFLAGRANT  
FUNKENFREI  
ANTISCINTILLA  
ANTI-DEFLAGRANTE  
ИСКРБЕЗОПАСНЫЙ**



COD.	MAT.	COD.	MAT.	L (mm)	O.D. mm	Kg
73847	Cu-Be	73848	Al-Bron	800	23	2,1
73849		73850			25	3,0
73851		73852		850	30	4,5
73853		73854			25	3,8
73855		73856		1000	28	4,5
73857		73858			30	5,5
73859		73860			25	4,5
73861		73862		1200	30	6,5
73863		73864			30	8,5
73865		73866			30	8,5

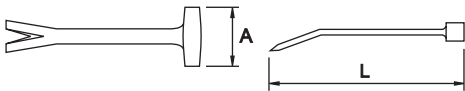

COD.	MAT.	COD.	MAT.	L (mm)	A (mm)	Kg
76545	Cu-Be	76546	Al-Bron	230	70	0,45



■ **BARRA DE DESENCOFRAR / WRECKING BAR / PINCE MONSEIGNEUR / BRECHEISEN / APRICASSE CON LEVA CHIODI / PE DE CABRA / КРЮК**

COD.	MAT.	COD.	MAT.	L (mm)	Kg
71573	Cu-Be	71577	Al-Bron	16 x 460	1,3
71574		71578		19 x 600	2,4
71575		71579		19 x 750	3,0
71576		71580		19 x 900	3,3



■ **HERRAMIENTA DE REMATAR / CAULKING TOOL / CLÉ DE FINITION / ABDICHTEN-WERKZEUG / UTENSILI DA SVENDERE / FERRAMENTA DE CALAFETAR / МОТИРОВОКА**

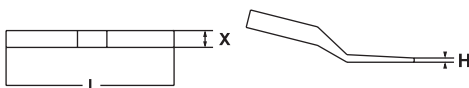

COD.	MAT.	COD.	MAT.	L (mm)	X	H (mm)	g
72601	Cu-Be	72602	Al-Bron	200	20	5	450
72603		72604		250		8	600



■ **CINCELES NEUMÁTICOS / PNEUMATIC CHISELS / BURINS PNEUMATIQUES / PNEUMATISCHE MEISSEL / SCALPELLO PNEUMATICO / ESCOPROS PNEUMÁTICOS / ПНЕВМО ДОЛОТА**

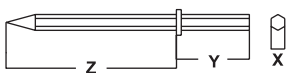

COD.	MAT.	COD.	MAT.	X	Y	Z	g
72583	Cu-Be	72584	Al-Bron	28	150	350	3200

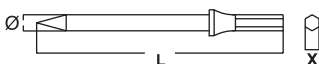

COD.	MAT.	COD.	MAT.	L (mm)	X	O.D. mm	g
72585	Cu-Be	72586	Al-Bron	125	10	12	120
72587		72588		175			170



**Cu-Be** Cobre berilio / Beryllium copper / Cuivre beryllium / Kupfer beryllium / Koper beryllium / Rame-berillio / Сплав Медь Бериллий  
**Al-Bron** Aluminio bronze / Aluminium bronze / Alliage aluminium-bronze / Alliage aluminium-bronze / Aluminium brons / Aluminio bronzo / Сплав Алюминий Бронза

Si no encuentra el artículo que necesita, consúltenos en [info@egamaster.com](mailto:info@egamaster.com) o en [www.egamaster.com](http://www.egamaster.com)  
 If you can't find the item you look for, please ask us in [info@egamaster.com](mailto:info@egamaster.com) or in [www.egamaster.com](http://www.egamaster.com)  
 Si vous ne trouvez pas l'article que vous desirez, consultez-nous à [info@egamaster.com](mailto:info@egamaster.com) ou à [www.egamaster.com](http://www.egamaster.com)

**EGAMaster**  
ART IN INNOVATION

# 05

**ANTICHISPA  
NON-SPARKING  
ANTIDÉFLAGRANT  
FUNKENFREI  
ANTISCINTILLA  
ANTI-DEFLAGRANTE  
ИСКРБЕЗОПАСНЫЙ**



COD.	MAT.	COD.	MAT.	L (mm)	X	Y	g
<b>72589</b>	Cu-Be	<b>72590</b>	Al-Bron	125	10	20	150
<b>72591</b>		<b>72592</b>		175			190

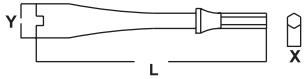

COD.	MAT.	COD.	MAT.	L (mm)	X	Y	g
<b>72593</b>	Cu-Be	<b>72594</b>	Al-Bron	125	10	20	150
<b>72595</b>		<b>72596</b>		175			190



COD.	MAT.	COD.	MAT.	L (mm)	X	Y	g
<b>72597</b>	Cu-Be	<b>72598</b>	Al-Bron	125	10	20	150
<b>72599</b>		<b>72600</b>		175			190

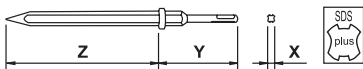

COD.	MAT.	COD.	MAT.	X	Y	Z	g
<b>35570</b>	Cu-Be	<b>35571</b>	Al-Bron	28	150	350	3200

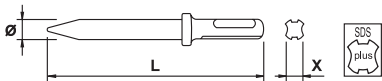

COD.	MAT.	COD.	MAT.	L (mm)	X	O.D. mm	g
<b>35572</b>	Cu-Be	<b>35573</b>	Al-Bron	125	10	12	120
<b>35574</b>		<b>35575</b>		175			170

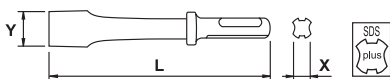

COD.	MAT.	COD.	MAT.	L (mm)	X	Y	g
<b>35576</b>	Cu-Be	<b>35577</b>	Al-Bron	125	10	20	150
<b>35578</b>		<b>35579</b>		175			190



**Cu-Be** Cobre berilio / Beryllium copper / Cuivre beryllium / Kupfer beryllium / Koper beryllium / Rame-berillio / Сплав Медь Бериллий  
**Al-Bron** Aluminio bronze / Aluminium bronze / Alliage aluminium-bronze / Alliage aluminium-bronze / Aluminium brons / Aluminio bronzo / Сплав Аллюминий Бронза

05

**ANTICHISPA  
NON-SPARKING  
ANTIDÉFLAGRANT  
FUNKENFREI  
ANTISCINTILLA  
ANTI-DEFLAGRANTE  
ИСКРБЕЗОПАСНЫЙ**

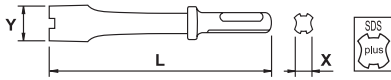

COD.	MAT.	COD.	MAT.	L (mm)	X	Y	g
35580	Cu-Be	35581	Al-Bron	125	10	20	150
35582		35583		175			190

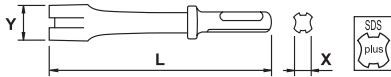

COD.	MAT.	COD.	MAT.	L (mm)	X	Y	g
35584	Cu-Be	35585	Al-Bron	125	10	20	150
35586		35587		175			190



#### TRAZADOR / MARKING TOOL / POINTE À TRACER / MARKIERUNGSWERKZEUG / TRACCIATORE / TRAÇADOR / МАРКИРОВЩИКИ

COD.	MAT.	COD.	MAT.	L (mm)	O.D. mm	g
74217	Cu-Be	74218	Al-Bron	400	12	500
74219		74220		600	16	1000



COD.	MAT.	COD.	MAT.	L (mm)	O.D. mm	g
72216	Cu-Be	72217	Al-Bron	190	4	15
74222		74223		250		20



#### PUNZÓN / AWL / POINÇON / AHLE / PUNZONE / PUNÇÃO / ШИЛО

COD.	MAT.	COD.	MAT.	L (mm)	O.D. mm	g
74225	Cu-Be	74226	Al-Bron	100 x 200	3	50



#### GANCHOS AJUSTABLES PARA BIDONES / ADJUSTABLE BARREL HOOKS / CROCHETS LÈVE BIDONS / VERSTELBARE FASSHAKEN / GANCIO REGOLABILE PER BIDONI / GANCHOS AJUSTÁVEIS PARA BIDONS / КРЮК ДЛЯ БОЧЕК РЕГУЛИРУЕМЫЙ

COD.	MAT.	COD.	MAT.	MAX mm	CAP. (kg)	g
74247	Cu-Be	74248	Al-Bron	1060	700	3200



#### RASQUETA / LONG BLADE SCRAPER / LONGUE RACLETTE / FLACHSCHABER / RASCHIETTO / RASCADOR / ШИРОКАЯ ЛОПАТКА

COD.	MAT.	COD.	MAT.	L x W (mm)	Kg
71562	Cu-Be	71566	Al-Bron	60 x 185	1,2
71563		71567		100 x 225	1,5
71564		71568		150 x 180	2,6
71565		71569		125 x 225	1,2











COD.	MAT.	COD.	MAT.	L (mm)	g
73759	Cu-Be	73760	Al-Bron	95 x 480	650





**Cu-Be** Cobre berilio / Beryllium copper / Cuiivre beryllium / Kupfer beryllium / Koper beryllium / Rame-berillio / Сплав Медь Бериллий  
**Al-Bron** Aluminio bronze / Aluminium bronze / Alliage aluminium-bronze / Alliage aluminium-bronze / Aluminium brons / Aluminio bronzo / Сплав Алюминий Бронза

Si no encuentra el artículo que necesita, consúltenos en [info@egamaster.com](mailto:info@egamaster.com) o en [www.egamaster.com](http://www.egamaster.com)  
 If you can't find the item you look for, please ask us in [info@egamaster.com](mailto:info@egamaster.com) or in [www.egamaster.com](http://www.egamaster.com)  
 Si vous ne trouvez pas l'article que vous desirez, consultez-nous à [info@egamaster.com](mailto:info@egamaster.com) ou à [www.egamaster.com](http://www.egamaster.com)



**EGAMaster**  
ART IN INNOVATION

COD.	MAT.	COD.	MAT.	L (mm)		
72155	Cu-Be	72156	Al-Bron	50 x 900	650	
73744	Cu-Be	73745	Al-Bron	50 x 900	650	
73750	Cu-Be	73751	Al-Bron	50 x 695	900	
73752		73753		75 x 710	1100	
73754		73755		100 x 710	1200	
73756		73757		150 x 750	2000	
72167	Cu-Be	72168	Al-Bron	40 x 270	350	
73747	Cu-Be	73749	Al-Bron	48 x 300	400	
73762	Cu-Be	73763	Al-Bron	75 x 600	650	

■ **RASQUETA CURVA / ARCHED SCRAPER / GRATTOIR COURBÉ / SPACHTEL FÜR GEBOGEN FLÄCHEN / RASPE CURVE / RASPADOR CURVO / ИЗОГНУТЫЙ СКРЕБОК**



COD.	MAT.	COD.	MAT.	L (mm)		
73765	Cu-Be	73766	Al-Bron	50 x 190	400	
73767		73768		100 x 210	650	
73769		73770		150 x 220	800	

■ **RASQUETA PLANA / FLAT SCRAPER / GRATTOIR PLAT / FLACHSCHABER / RASCHIETTO PIATTO / RASPADOR PLANO / ЛОСКИЙ СКРЕБОК**

COD.	MAT.	COD.	MAT.	L (mm)		
72157	Cu-Be	72162	Al-Bron	30 x 200	300	
72158		72163		30 x 300	425	
72159		72164		35 x 350	550	
72160		72165		50 x 350	900	
72161		72166		60 x 400	1400	

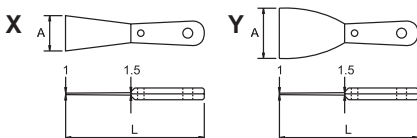
■ **ESPÁTULA / SCRAPER / SPATULE / SPACHTEL / SPATOLA / ESPATULA / СКРЕБОК**



COD.	MAT.	COD.	MAT.	A (mm)	L (mm)		
70471	Cu-Be	71621	Al-Bron	25	200	85	
70472		71622		30		95	
70473		71623		40		105	
70474		71624		50		115	
70475		71625		60		115	
79834		79835		140		190	

# 05

**ANTICHISPA  
NON-SPARKING  
ANTIDÉFLAGRANT  
FUNKENFREI  
ANTISCINTILLA  
ANTI-DEFLAGRANTE  
ИСКРБЕЗОПАСНЫЙ**



COD.	MAT.	COD.	MAT.	A (mm)	L (mm)	g
70476	Cu-Be	71626	Al-Bron	75	200	135
70477		71627		80		150
70478		71628		100		

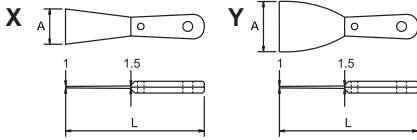

COD.	MAT.	COD.	MAT.	A (mm)	L (mm)	g
36030	Cu-Be	36031	Al-Bron	25	200	100
36032		36033		30		110
36034		36035		40		120
36036		36037		50		130
36038		36039		60		140



COD.	MAT.	COD.	MAT.	A (mm)	L (mm)	g
36040	Cu-Be	36041	Al-Bron	75	200	180
36042		36043		80		190
36044		36045		100		220

**ESPÁTULA DE HOJA FLEXIBLE / FLEXIBLE BLADE SCRAPER / SPATULE À LÂME SOUPLE / SCHABER MIT FLEXIBLES BLATT / SPATOLA FLESSIBILE / ESPÁTULA DE FOLHA FLÉXIVEL / ШПАТЕЛЬ**

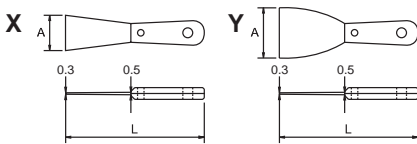

COD.	MAT.	COD.	MAT.	A (mm)	L (mm)	g
35730	Cu-Be	35731	Al-Bron	25	200	85
35732		35733		30		95
35734		35735		40		105
35736		35737		50		115
35738		35739		60		



COD.	MAT.	COD.	MAT.	A (mm)	L (mm)	g
35740	Cu-Be	35741	Al-Bron	75	200	135
35742		35743		80		150
35744		35745		100		

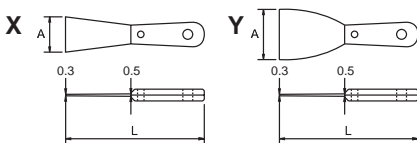

COD.	MAT.	COD.	MAT.	A (mm)	L (mm)	g
36046	Cu-Be	36047	Al-Bron	25	200	100
36048		36049		30		110
36050		36051		40		120
36052		36053		50		130
36054		36055		60		140



**Cu-Be** Cobre berilio / Beryllium copper / Cuivre beryllium / Kupfer beryllium / Koper beryllium / Rame-berillio / Сплав Медь Бериллий  
**Al-Bron** Aluminio bronze / Aluminium bronze / Alliage aluminium-bronze / Alliage aluminium-bronze / Aluminium brons / Aluminio bronzo / Сплав Аллюминий Бронза

Si no encuentra el artículo que necesita, consúltenos en [info@egamaster.com](mailto:info@egamaster.com) o en [www.egamaster.com](http://www.egamaster.com)  
 If you can't find the item you look for, please ask us in [info@egamaster.com](mailto:info@egamaster.com) or in [www.egamaster.com](http://www.egamaster.com)  
 Si vous ne trouvez pas l'article que vous desirez, consultez-nous à [info@egamaster.com](mailto:info@egamaster.com) ou à [www.egamaster.com](http://www.egamaster.com)



05

**ANTICHISPA  
NON-SPARKING  
ANTIDÉFLAGRANT  
FUNKENFREI  
ANTISCINTILLA  
ANTI-DEFLAGRANTE  
ИСКРОБЕЗОПАСНЫЙ**



COD.	MAT.	COD.	MAT.	A (mm)	L (mm)	
36056	Cu-Be	36057	Al-Bron	75	200	180
36058		36059		80		190
36060		36061		100		220

**RASQUETA TRIANGULAR / TRIANGULAR SCRAPER / GRATTOIR TRIANGULAIRE / DREIECKIGER SPACHTEL / RASCHIETTO TRIANGOLARE / RASCADOR TRIANGULAR / ТРЕУГОЛЬНЫЙ СКРЕБОК**

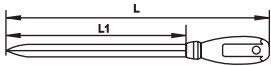

COD.	MAT.	COD.	MAT.	L (mm)	L1 (mm)	
73422	Cu-Be	73399	Al-Bron	360	255	250



COD.	MAT.	COD.	MAT.	L (mm)	
73775	Cu-Be	73776	Al-Bron	150 x 470	1000



**PICO Y RASQUETA / SCRAPER PICK AND SCALER / PIQUE ET RACLETTE / REINIGUNGSWERKZEUG / PICCONE E RASCHIETTI / BICO E PÁ / СКАЛЫВАЮЩИЙ СКРЕБОК**

COD.	MAT.	COD.	MAT.	L (mm)	
73785	Cu-Be	73786	Al-Bron	75 x 450	1200



**LLANA / TROWEL / TRUELLE / KELLEN / FRATTONI / TALOCHA / ГЛАДИЛКА**

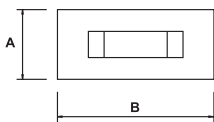

COD.	MAT.	COD.	MAT.	A (mm)	B (mm)	
36070	Cu-Be	36071	Al-Bron	150	300	850



**CUBO / BUCKET / SEAU / EIMER / SECCHIO / BALDE / ВЕДРО**

COD.	MAT.	L (mm)		
72486	Cu-Be	250	270	1500



**CUCHARA RECOGEDORA DE AZÚCAR / SUGAR SCOOP / CUILLÈRE À SUCRE / SCHÖPFSCHAUFEL / RACCOGLITORE DI ZUCCHERI / COLHER PARA AÇUCAR / КОВШ**

COD.	MAT.	L (mm)	Ø 1 (mm)	Ø 2 (mm)	H (mm)	H1 (mm)	
72487	Cu-Be	150	70	45	40	87	100
72488		200	120	100	75	118	250
72489		270	140	120	80	149	350
74620		350	160	135	90	190	600



**Cu-Be** Cobre berilio / Beryllium copper / Cuivre beryllium / Kupfer beryllium / Koper beryllium / Rame-berillio / Сплав Медь Бериллий  
**Al-Bron** Aluminio bronce / Aluminium bronze / Alliage aluminium-bronze / Alliage aluminium-bronze / Aluminium brons / Aluminio bronzo / Сплав Алюминий Бронза

05

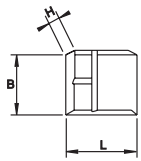

**ANTICHISPA  
NON-SPARKING  
ANTIDÉFLAGRANT  
FUNKENFREI  
ANTISCINTILLA  
ANTI-DEFLAGRANTE  
ИСКРОБЕЗОПАСНЫЙ**





COD.	MAT.	L (mm)	H (mm)	B (mm)	
74621	Cu-Be	150	20	130	130
74622		200		200	335
74623		270	50	250	650
72490		350	60	320	1000





#### AGUJA / NEEDLE / AIGUILLE / NADEL / AGO / AGULHA / ИГЛА

COD.	MAT.	COD.	MAT.	L (mm)		
73868	Cu-Be	73869	Al-Bron	250	6	80
73870		73871		300	8	150
73872		73873		400	7	160
73874		73875		500	10	320

COD.	MAT.	L (mm)		
73877	Cu-Be	180	3	12





#### EMBUDO / FUNNEL / ENTONNOIR / TRICHTER / IMBUTO / FUNIL / ВОРОНКА

COD.	MAT.	L (mm)		
74240	Cu-Be	130	160	230
74241		165		250





#### BOMBA MANUAL DE ACEITE / PORTABLE OIL PUMP / BURETTE À HUILE / TRAGBARE ÖLPUMPE / POMPA DELL'OLIO MANULE / BOMBA MANUAL PARA ÓLEO / ПЕРЕНОСНОЙ МАСЛЯНЫЙ НАСОС

COD.	MAT.	L (mm)		
74243	Cu-Be	1100	165	2300





#### CAZO / DIPPER / LOUCHE / TRICHTER KANNE / RECIPIENTE / CONCHA / КОВШ

COD.	MAT.	L (mm)		
74245	Cu-Be	350	85	200



#### PLOMADA / LINER / PLOMB / SCHLAGSCHNURROLLER / GESSO TRACCIATORE / LINHAS DE TRAÇAR / ОТБЕЖ

COD.	MAT.	COD.	MAT.	L (mm)		
72454	Cu-Be	72455	Al-Bron	60	50	250



**Cu-Be** Cobre berilio / Beryllium copper / Cuiivre beryllium / Kupfer beryllium / Koper beryllium / Rame-berillio / Сплав Медь Бериллий  
**Al-Bron** Aluminio bronze / Aluminium bronze / Alliage aluminium-bronze / Alliage aluminium-bronze / Aluminium brons / Aluminio bronzo / Сплав Алюминий Бронза

Si no encuentra el artículo que necesita, consúltenos en [info@egamaster.com](mailto:info@egamaster.com) o en [www.egamaster.com](http://www.egamaster.com)  
 If you can't find the item you look for, please ask us in [info@egamaster.com](mailto:info@egamaster.com) or in [www.egamaster.com](http://www.egamaster.com)  
 Si vous ne trouvez pas l'article que vous desirez, consultez-nous a [info@egamaster.com](mailto:info@egamaster.com) ou a [www.egamaster.com](http://www.egamaster.com)

05

**ANTICHISPA  
NON-SPARKING  
ANTIDÉFLAGRANT  
FUNKENFREI  
ANTISCINTILLA  
ANTI-DEFLAGRANTE  
ИСКРОБЕЗОПАСНЫЙ**



**POLEA / CHAIN HOIST / PALAN / KETTENZUG / PARANCHI A MANO CON CATENA / DIFERENCIAL MANUAL / ЦЕПНАЯ ТАЛЬ**

COD.	MAT.	COD.	MAT.	CAP. (kg)	CAP. (m)	Kg
71638	Cu-Be	71642	Al-Bron	500	3	14
71639		71643		1000		
71640		71644		2000		
71641		71645		3000		
72141		72142		5000		



**CARRO PARA POLEA / TROLLEY FOR CHAIN HOIST / CHARIOT POUR PALAN / WAREN FÜR KETTENHUB / CARRELLO PER PULEGIA / CARRO PARA DIFERENCIAL / ТЕЛЕЖКА ДЛЯ ЦЕПНЫХ ТАЛЕЙ**

COD.	MAT.	COD.	MAT.	CAP. (kg)	I	Kg
76693	Cu-Be	76694	Al-Bron	500	68-94	13
76695		76696		1000	68-100	16
76697		76698		2000	94-124	22
76699		76700		3000	116-140	24



**GRILLETE / SHACKLE / MANILLE / SCHÄKEL / GRILLI / MANILHA / РЫМ**

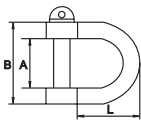

COD.	MAT.	COD.	MAT.	Kg-MAX	A (mm)	B (mm)	L	g
73429	Cu-Be	73424	Al-Bron	1200	30	50	55	170



**TRANSPALETA HIDRÁULICA / HYDRAULIC PALLET TRUCK / TRANSPALETTE HYDRAULIQUE / HYDRAULISCHER HUBWAGEN / TRASPALLET IDRAULICO / PORTA-PALETES HIDRÁULICO / ГИДРАВЛИЧЕСКАЯ ТЕЛЕЖКА**

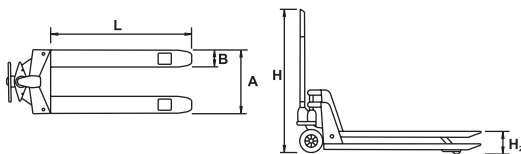

COD.	MAT.	COD.	MAT.	CAP. (kg)	L	A (mm)	B (mm)	H (mm)	H2 (mm)	Kg
76547	Cu-Be	76548	Al-Bron	2000	1190	550	160	1240	90-190	125



**GATO / SCREW JACK / CRIQUE HYDRAULIQUE / HEBEBOCK / MARTINETTO IDRAULICO / MACACO HIDRÁULICO DE GARRAFA / ВИНТОВОЙ ДОМКРАТ**

COD.	MAT.	CAP. (kg)	H (mm)	Kg
76703	Al-Bron	3200	220-330	6,5
76705		5000	250-380	7
76707		10000	280-430	11
76709		16000	320-500	14



**Cu-Be** Cobre berilio / Beryllium copper / Cuivre beryllium / Kupfer beryllium / Koper beryllium / Rame-berillio / Сплав Медь Бериллий  
**Al-Bron** Aluminio bronce / Aluminium bronze / Alliage aluminium-bronze / Alliage aluminium-bronze / Aluminium brons / Aluminio bronzo / Сплав Аллюминий Бронза



CEPILLOS / BRUSHES / BROSSES / STAHLBÜRSTEN / SPAZZOLE / ESCOVAS / ЩЕТКИ

COD.	N.º filas / Rows / Rangées	L (mm)	
70479	3		170
70480	4	280	200
70481	5		220



CARACTERÍSTICAS / FEATURES / CARACTÉRISTIQUES

Latón / Brass / Laiton

COD.	N.º filas / Rows / Rangées	L (mm)	
71632	5	180	200



CARACTERÍSTICAS / FEATURES / CARACTÉRISTIQUES

Latón / Brass / Laiton

COD.	N.º filas / Rows / Rangées	L (mm)	
72739	3	350	150



CARACTERÍSTICAS / FEATURES / CARACTÉRISTIQUES

Latón / Brass / Laiton

COD.	N.º filas / Rows / Rangées	L (mm)	
73419	6	215	60
72526	4	290	170



CARACTERÍSTICAS / FEATURES / CARACTÉRISTIQUES



Latón / Brass / Laiton

COD.	N.º filas / Rows / Rangées	L (mm)		
61581	4	280	120	3



CARACTERÍSTICAS / FEATURES / CARACTÉRISTIQUES

Latón / Brass / Laiton

COD.	 I.D. mm	 O.D. mm	
71634	22,2	150	700
73426	32	200	1000



CARACTERÍSTICAS / FEATURES / CARACTÉRISTIQUES

Latón / Brass / Laiton

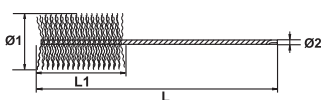

COD.	L (mm)	L1 (mm)	Ø 1 (mm)	Ø 2 (mm)	
79226	320	100	82	6,6	55



CARACTERÍSTICAS / FEATURES / CARACTÉRISTIQUES

Latón / Brass / Laiton

Cerdas antiestáticas / Antistatic bristles / Brosses antistatiques

**PICOS / PICKS / PIOCHES / MAURER HAMMERS / PICCONI / PICADEIRA / КИРКИ**

COD.	MAT.	COD.	MAT.	L (mm)	H (mm)	B (mm)	Kg
72143	Cu-Be	72147	Al-Bron	1050	360	53	1,1
72144		72148			385	55	1,7
72145		72149			410	56	2,0
72146		72150			470		2,5

**HACHA / AXE / HACHE / AXTE / ASCIA / MACHADO / ТОПОР**

COD.	MAT.	COD.	MAT.	L (mm)	H (mm)	B (mm)	g
72153	Cu-Be	72154	Al-Bron	340	200	82	950

**HACHA BOMBERO / FIREMAN TYPE AXE / HACHE POUR POMPIERS / FEUERWEHRAXT / ASCIA TIPO PER POMPIERI / MACHADO DE BOMBEIRO / ТОПОР ПОЖАРНОГО ТИПА**

COD.	MAT.	COD.	MAT.	L (mm)	A (mm)	B (mm)	Kg
72151	Cu-Be	72152	Al-Bron	340	145	98	1,3

**MARTILLOS / HAMMERS / MARTEAUX / HÄMMER / MARTELLI / MARTELOS / МОЛОТКИ**
**MARTILLO DE BOLA / BALL PEIN HAMMER / MARTEAU À BOULE / SCHLOSSER HAMMER / MARTELLO A PALLA / MARTELO DE BOLA / МОЛОТОК С ШАРОВОЙ ГОЛОВКОЙ**

COD.	MAT.	COD.	MAT.	L (mm)	g
70488	Cu-Be	71743	Al-Bron	280	200
70489		71744		310	500
70490		71745		340	700
70491		71746		350	900

**CARACTERÍSTICAS / FEATURES / CARACTÉRISTIQUES**

Fibra de vidrio / Fiberglass / Fibre en verre

COD.	MAT.	COD.	MAT.	L (mm)	g
35933	Cu-Be	35937	Al-Bron	280	200
35934		35938		310	500
35935		35939		340	700
35936		35940		350	900

**CARACTERÍSTICAS / FEATURES / CARACTÉRISTIQUES**

Madera de nogal / Hickory wood / Bois de noyer

COD.	MAT.	COD.	MAT.	L (mm)	g
72782	Latón / Brass / Laiton	72788	Cu	280	230
72783		72789		340	340
72784		72790		310	450
72785		72791		340	680
72786		72792		350	910
72787		72793		400	1130

**CARACTERÍSTICAS / FEATURES / CARACTÉRISTIQUES**

Fibra de vidrio / Fiberglass / Fibre en verre

<b>Cu-Be</b>	Cobre berilio / Beryllium copper / Cuivre beryllium / Kupfer beryllium / Koper beryllium / Rame-berillio / Сплав Медь Бериллий
<b>Al-Bron</b>	Aluminio bronce / Aluminium bronze / Alliage aluminium-bronze / Alliage aluminium-bronze / Aluminium brons / Aluminio bronzo / Сплав Аллюминий Бронза
<b>Lat/Brass</b>	Latón / Brass / Laiton / Messing / Ottone / Latão / БРОНЗА
<b>Cu</b>	Cobre / Copper / Cuivre / Kupfer / Rame / Cobre / МЕДНАЯ

05

**ANTICHISPA  
NON-SPARKING  
ANTIDÉFLAGRANT  
FUNKENFREI  
ANTISCINTILLA  
ANTI-DEFLAGRANTE  
ИСКРБЕЗОПАСНЫЙ**



COD.	MAT.	COD.	MAT.	L (mm)	g
36001	Latón / Brass / Laiton	36007	Cu	300	230
36002		36008			340
36003		36009			450
36004		36010		680	
36005		36011		910	
36006		36012		1130	



**CARACTERÍSTICAS / FEATURES / CARACTÉRISTIQUES**

Madera de nogal / Hickory wood / Bois de noyer

**MARTILLO MECÁNICO DE PEÑA / ENGINEER'S CROSS PEIN HAMMER / MARTEAU À GARNIR / MECCANICO CON PENNA / SCHLOSSER HAMMER / MECÂNICO DE PENA / МОЛОТОК С ШАРОВОЙ ГОЛОВКОЙ**

COD.	MAT.	COD.	MAT.	L (mm)	g
70492	Cu-Be	71747	Al-Bron	350	500
70493		71748			900



**CARACTERÍSTICAS / FEATURES / CARACTÉRISTIQUES**

Fibra de vidrio / Fiberglass / Fibre en verre

COD.	MAT.	COD.	MAT.	L (mm)	g
35941	Cu-Be	35943	Al-Bron	380	500
35942		35944			900



**CARACTERÍSTICAS / FEATURES / CARACTÉRISTIQUES**

Madera de nogal / Hickory wood / Bois de noyer

**MARTILLO ALEMÁN / GERMAN TYPE MACHINIST'S HAMMER / MARTEAU DE MECANICIEN / SCHLOSSER HAMMER / MARTELO TEDESCO / MARTELO TIPO ALEMÃO / СЛЕСАРНЫЙ МОЛОТОК НЕМЕЦКОГО ТИПА**

COD.	MAT.	COD.	MAT.	L (mm)	g
70494	Cu-Be	71749	Al-Bron	300	100
70495		71750			200
70496		71751			300
70497		71752			500
70498		71753		800	
70499		71754		1000	
70500		71755		1500	
70501		71756		2000	



**CARACTERÍSTICAS / FEATURES / CARACTÉRISTIQUES**

Fibra de vidrio / Fiberglass / Fibre en verre

COD.	MAT.	COD.	MAT.	L (mm)	g
35945	Cu-Be	35953	Al-Bron	300	100
35946		35954			200
35947		35955			300
35948		35956			500
35949		35957		800	
35950		35958		1000	
35951		35959		1500	
35952		35960		2000	



**CARACTERÍSTICAS / FEATURES / CARACTÉRISTIQUES**

Madera de nogal / Hickory wood / Bois de noyer

<b>Cu-Be</b>	Cobre berilio / Beryllium copper / Cuivre beryllium / Kupfer beryllium / Koper beryllium / Rame-berillio / Сплав Медь Бериллий
<b>Al-Bron</b>	Aluminio bronze / Aluminium bronze / Alliage aluminium-bronze / Alliage aluminium-bronze / Aluminium brons / Aluminio bronzo / Сплав Алюминий Бронза
<b>Lat/Brass</b>	Latón / Brass / Laiton / Messing / Ottone / Latão / БРОНЗА
<b>Cu</b>	Cobre / Copper / Cuivre / Kupfer / Rame / Cobre / МЕДНАЯ

Si no encuentra el artículo que necesita, consúltenos en [info@egamaster.com](mailto:info@egamaster.com) o en [www.egamaster.com](http://www.egamaster.com)  
If you can't find the item you look for, please ask us in [info@egamaster.com](mailto:info@egamaster.com) or in [www.egamaster.com](http://www.egamaster.com)  
Si vous ne trouvez pas l'article que vous desirez, consultez-nous a [info@egamaster.com](mailto:info@egamaster.com) ou a [www.egamaster.com](http://www.egamaster.com)

**MACETA OCTOGONAL / SLEDGE HAMMER / MASSETTE OCTOGONALE / SCHLAGHAMMER / MAZZETTA OTTOGONALE / MARRETA OCTOGONAL / КУВАЛДА**

COD.	MAT.	COD.	MAT.	L (mm)	Kg
36215		36028		370	0,5
70502		71757			1
70503		71758			1,5
70504		71759			2,0
70505		71760			2,5
70506		71761			3,0
70507	Cu-Be	71762	Al-Bron	900	4,5
70508		71763			5,0
70509		71764			6,8
70510		71765			8,0
72213		72211			10
72975		72974			12

**CARACTERÍSTICAS / FEATURES / CARACTÉRISTIQUES**

Fibra de vidrio / Fiberglass / Fibre en verre

COD.	MAT.	COD.	MAT.	L (mm)	Kg
36184		36185		370	0,5
35865		35882			1
35866		35883			1,5
35867		35884			2,0
35868		35885			2,5
35869		35886			3,0
35870	Cu-Be	35887	Al-Bron	900	4,5
35871		35888			5,0
35872		35889			6,8
35873		35890			8,0
35874		35891			10
35875		35892			12

**CARACTERÍSTICAS / FEATURES / CARACTÉRISTIQUES**

Madera de nogal / Hickory wood / Bois de noyer

COD.	MAT.	COD.	MAT.	L (mm)	lb
79930		79931		380	2
35762		35763			3
35764		35765			5
35766		35767		840	7,5
35768	Cu-Be	35769	Al-Bron		10
79932		79933			12
35770		35771			15
35772		35773			18

**CARACTERÍSTICAS / FEATURES / CARACTÉRISTIQUES**

Fibra de vidrio / Fiberglass / Fibre en verre

COD.	MAT.	COD.	MAT.	L (mm)	lb
36438		36439		380	2
35876		35893			3
35877		35894			5
35878		35895		840	7,5
35879	Cu-Be	35896	Al-Bron		10
36440		36441			12
35880		35897			15
35881		35898			18

**CARACTERÍSTICAS / FEATURES / CARACTÉRISTIQUES**

Madera de nogal / Hickory wood / Bois de noyer

**Cu-Be** Cobre berilio / Beryllium copper / Cuivre beryllium / Kupfer beryllium / Koper beryllium / Rame-berillio / Сплав Медь Бериллий  
**Al-Bron** Aluminio bronze / Aluminium bronze / Alliage aluminium-bronze / Alliage aluminium-bronze / Aluminium brons / Aluminio bronzo / Сплав Алюминий Бронза

05

**ANTICHISPA  
NON-SPARKING  
ANTIDÉFLAGRANT  
FUNKENFREI  
ANTISCINTILLA  
ANTI-DEFLAGRANTE  
ИСКРОБЕЗОПАСНЫЙ**



COD.	MAT.	L (mm)	 g
72740	Latón / Brass / Laiton	280	300
72741		300	500
72742		1000	
72743		370	1500
72744		2000	
72745		3000	
72746		4000	
72747		900	5000
72748		7000	
72749		10000	



#### CARACTERÍSTICAS / FEATURES / CARACTÉRISTIQUES

Fibra de vidrio / Fiberglass / Fibre en verre

COD.	MAT.	L (mm)	 g
35965	Latón / Brass / Laiton	310	300
35966			500
35967		320	1000
35968		360	1500
35969		380	2000
35970		700	3000
35971		800	4000
35972			5000
35973			7000
35974		900	10000



#### CARACTERÍSTICAS / FEATURES / CARACTÉRISTIQUES

Madera de nogal / Hickory wood / Bois de noyer

COD.	MAT.	L (mm)	 g
72750	Cu	300	450
72751		370	1000
72752		2500	
72753		3600	
72754		4500	
72755		900	5400
72756		6400	
72757		10000	



#### CARACTERÍSTICAS / FEATURES / CARACTÉRISTIQUES

Fibra de vidrio / Fiberglass / Fibre en verre

COD.	MAT.	L (mm)	 g
35975	Cu	310	450
35976		320	1000
35977		380	2500
35978		700	3600
35979		4500	
35980		800	5400
35981		6400	
35982		900	10000



#### CARACTERÍSTICAS / FEATURES / CARACTÉRISTIQUES

Madera de nogal / Hickory wood / Bois de noyer

**Lat/Brass** Latón / Brass / Laiton / Messing / Ottone / Latao / БРОНЗА  
**Cu** Cobre / Copper / Cuivre / Kupfer / Rame / Cobre / МЕДНАЯ

Si no encuentra el artículo que necesita, consúltenos en [info@egamaster.com](mailto:info@egamaster.com) o en [www.egamaster.com](http://www.egamaster.com)  
If you can't find the item you look for, please ask us in [info@egamaster.com](mailto:info@egamaster.com) or in [www.egamaster.com](http://www.egamaster.com)  
Si vous ne trouvez pas l'article que vous desirez, consultez-nous à [info@egamaster.com](mailto:info@egamaster.com) ou à [www.egamaster.com](http://www.egamaster.com)

**EGA Master**  
ART IN INNOVATION

**MASCETA CUADRADA TIPO ALEMÁN / GERMAN TYPE STONING HAMMER / MASSETTE TYPE ALLEMAND / FÄUSTEL / MAZZETA / MARRETA / КУВАЛДА КАМЕНЩИКА НЕМЕЦКОГО ТИПА**

COD.	MAT.	COD.	MAT.	L (mm)	Kg
70511	Cu-Be	71766	Al-Bron	400	1
70512		71767			1,5
70513		71768			2
70514		71769		900	2,5
70515		71770		3	
72098		72099		3,5	

**CARACTERÍSTICAS / FEATURES / CARACTÉRISTIQUES**

Fibra de vidrio / Fiberglass / Fibre en verre

COD.	MAT.	COD.	MAT.	L (mm)	Kg
35899	Cu-Be	35905	Al-Bron	380	1
35900		35906			1,5
35901		35907			2
35902		35908		900	2,5
35903		35909		3	
35904		35910		3,5	

**CARACTERÍSTICAS / FEATURES / CARACTÉRISTIQUES**

Madera de nogal / Hickory wood / Bois de noyer

**MAZA CUADRADA TIPO ALEMÁN / GERMAN TYPE STONING HAMMER / MASSE CARREE TYPE ALLEMAND / STEINSLAGHAMMER / MAZZA / MARRETA QUADRADA / МОЛОТОК КАМЕНЩИКА НЕМЕЦКОГО ТИПА**

COD.	MAT.	COD.	MAT.	L (mm)	g
72764	Latón / Brass / Laiton	72773	Cu	350	500
72765		72774			1000
72766		72775			1500
72767		72776		400	1800
72768		72777			2000
72769		72778			2700
72770		72779		900	3600
72771		72780			4000
72772		72781			5000

**CARACTERÍSTICAS / FEATURES / CARACTÉRISTIQUES**

Fibra de vidrio / Fiberglass / Fibre en verre

COD.	MAT.	COD.	MAT.	L (mm)	g
35983	Latón / Brass / Laiton	35992	Cu	310	500
35984		35993		320	1000
35985		35994		360	1500
35986		35995		380	1800
35987		35996			2000
35988		35997			2700
35989		35998		700	3600
35990		35999		800	4000
35991		36000		900	5000

**CARACTERÍSTICAS / FEATURES / CARACTÉRISTIQUES**

Madera de nogal / Hickory wood / Bois de noyer

<b>Cu-Be</b>	Cobre berilio / Beryllium copper / Cuivre beryllium / Kupfer beryllium / Koper beryllium / Rame-berillio / Сплав Медь Бериллий
<b>Al-Bron</b>	Aluminio bronze / Aluminium bronze / Alliage aluminium-bronze / Alliage aluminium-bronze / Aluminium brons / Aluminio bronzo / Сплав Аллюминий Бронза
<b>Lat/Brass</b>	Latón / Brass / Laiton / Messing / Otton / Latão / БРОНЗА
<b>Cu</b>	Cobre / Copper / Cuivre / Kupfer / Rame / Cobre / МЕДНАЯ

**MARTILLO DE CORTE / CUT-OFF HAMMER / MARTEAU DE COUPE / SCHNEIDHAMMER / MARTELLO DE TAGLIO / MARTELO DE CORTE / ОТРУБНОЙ МОЛОТОК**

COD.	MAT.	COD.	MAT.	L (mm)	Kg
70516	Cu-Be	71771	Al-Bron	400	1,3
70517		71772			2,1

**CARACTERÍSTICAS / FEATURES / CARACTÉRISTIQUES**

Fibra de vidrio / Fiberglass / Fibre en verre

COD.	MAT.	COD.	MAT.	L (mm)	Kg
35961	Cu-Be	35963	Al-Bron	380	1,3
35962		35964			2,1

**CARACTERÍSTICAS / FEATURES / CARACTÉRISTIQUES**

Madera de nogal / Hickory wood / Bois de noyer

**PICO DE CALDERERO / CHIPPING HAMMER / PIOCHE DE CHAUDRONNIER / KESSELSTEINHAMMER / PICCONE DA BATTIRAME / PADEIRA DE CALDEIREIRO / МОЛОТОК КОЛУН**

COD.	MAT.	COD.	MAT.	L (mm)	g
70518	Cu-Be	71773	Al-Bron	280	200
70519		71774		355	400
70520		71775		400	600
70521		71776		400	900

**CARACTERÍSTICAS / FEATURES / CARACTÉRISTIQUES**

Fibra de vidrio / Fiberglass / Fibre en verre

COD.	MAT.	COD.	MAT.	L (mm)	g
35911	Cu-Be	35915	Al-Bron	280	200
35912		35916		355	400
35913		35917		400	600
35914		35918		380	900

**CARACTERÍSTICAS / FEATURES / CARACTÉRISTIQUES**

Madera de nogal / Hickory wood / Bois de noyer

**MARTILLO PARA PIEDRA / STONE WEDGE / MARTEAU PLAT / MAURERHAMMER / MARTELLO PER PIETRE / MARTELO PARA PEDRA / МОЛОТОК КАМЕНЩИКА**

COD.	MAT.	COD.	MAT.	L (mm)	Kg
70522	Cu-Be	71777	Al-Bron	400	1

**CARACTERÍSTICAS / FEATURES / CARACTÉRISTIQUES**

Fibra de vidrio / Fiberglass / Fibre en verre

COD.	MAT.	COD.	MAT.	L (mm)	Kg
35919	Cu-Be	35920	Al-Bron	380	1

**CARACTERÍSTICAS / FEATURES / CARACTÉRISTIQUES**

Madera de nogal / Hickory wood / Bois de noyer

**PALA MARTILLO / BRICKLAYER'S HAMMER / PELLE-MARTEAU / MAURERHAMMER / MARTELLO PICCONE / PA-MARTELO / МОЛОТОК КИРПИЧНИКА**

COD.	MAT.	COD.	MAT.	L (mm)	g
70523	Cu-Be	71778	Al-Bron	340	600
70524		71779			800

**CARACTERÍSTICAS / FEATURES / CARACTÉRISTIQUES**

Fibra de vidrio / Fiberglass / Fibre en verre

**Cu-Be** Cobre berilio / Beryllium copper / Cuivre beryllium / Kupfer beryllium / Koper beryllium / Rame-berillio / Сплав Медь Бериллий  
**Al-Bron** Aluminio bronze / Aluminium bronze / Alliage aluminium-bronze / Alliage aluminium-bronze / Aluminium brons / Aluminio bronzo / Сплав Аллюминий Бронза

05

ANTICHISPA  
NON-SPARKING  
ANTIDÉFLAGRANT  
FUNKENFREI  
ANTISCINTILLA  
ANTI-DEFLAGRANTE  
ИСКРОБЕЗОПАСНЫЙ



COD.	MAT.	COD.	MAT.	L (mm)	g
35921	Cu-Be	35923	Al-Bron	340	600
35922		35924			800



CARACTERÍSTICAS / FEATURES / CARACTÉRISTIQUES

Madera de nogal / Hickory wood / Bois de noyer

MARTILLO DE UÑA / CLAW HAMMER / MARTEAU DE CHARPENTIER / KLAUEN HAMMER / MARTELLO CARPENTIERE / MARTELO DE UNHA / МОЛОТОК С ГВОЗДОДЕРОМ

COD.	MAT.	COD.	MAT.	L (mm)	g
70525	Cu-Be	71780	Al-Bron	275	500
70526		71781		338	700



CARACTERÍSTICAS / FEATURES / CARACTÉRISTIQUES

Fibra de vidrio / Fiberglass / Fibre en verre

COD.	MAT.	COD.	MAT.	L (mm)	g
35925	Cu-Be	35927	Al-Bron	275	500
35926		35928		338	700



CARACTERÍSTICAS / FEATURES / CARACTÉRISTIQUES

Madera de nogal / Hickory wood / Bois de noyer

MARTILLO DE NYLON / NYLON HAMMER / MARTEAU NYLON / PLASTIK HAMMER / MARTELLO DI NYLON / MARTELO DE NYLON / НЕЙЛОНОВЫЙ МОЛОТОК

COD.	MAT.	COD.	MAT.	L (mm)	O.D. mm	g
70527	Cu-Be	71782	Al-Bron	340	50	800
73473		73393		400	55	1000



CARACTERÍSTICAS / FEATURES / CARACTÉRISTIQUES

Fibra de vidrio / Fiberglass / Fibre en verre

COD.	MAT.	COD.	MAT.	L (mm)	O.D. mm	g
35929	Cu-Be	35931	Al-Bron	340	50	800
35930		35932		380	55	1000



CARACTERÍSTICAS / FEATURES / CARACTÉRISTIQUES

Madera de nogal / Hickory wood / Bois de noyer

MARTILLO DE TESTEO / TESTING HAMMER / MARTEAU DE TEST / PRÜFHAMMER / MARTELLO DA TEST / MARTELO DE TESTES / ПРОВЕРОЧНЫЙ МОЛОТОК

COD.	MAT.	COD.	MAT.	L (mm)	g
75211	Cu-Be	75212	Al-Bron	380	125
75214		75213			250



CARACTERÍSTICAS / FEATURES / CARACTÉRISTIQUES

Madera de nogal / Hickory wood / Bois de noyer

**Cu-Be** Cobre berilio / Beryllium copper / Cuivre beryllium / Kupfer beryllium / Koper beryllium / Rame-berillio / Сплав Медь Бериллий  
**Al-Bron** Aluminio bronce / Aluminium bronze / Alliage aluminium-bronze / Alliage aluminium-bronze / Aluminium brons / Aluminio bronzo / Сплав Алюминий Бронза



**MAZA TIPO TAMBOR / DRUM TYPE STONING HAMMER / MASSETTE CONIQUE / LEICHMETALLHAMMER / MAZZA TIPO A TAMBURO / MAÇO DE COBRE / БОЧКООБРАЗНЫЙ МОЛОТОК**

COD.	MAT.	L (mm)	g
72758	Cu	280	300
72759		310	570
72760		340	810
72761		350	1100
72762		400	1600
72763		400	2300



**CARACTERÍSTICAS / FEATURES / CARACTÉRISTIQUES**

Madera de nogal / Hickory wood / Bois de noyer

**MARTILLO DE PICAR / SCALING HAMMER / MASSETTE À PIQUER / SCHWEISSERHAMMER / MARTELLO PER SCANALARE / PICADEIRA COM CABO DE FIBRA DE VIDRO / СКАЛЫВАЮЩИЙ МОЛОТОК**

COD.	MAT.	L (mm)	g
72794	Lat / Brass	330	205
72795		350	370



**CARACTERÍSTICAS / FEATURES / CARACTÉRISTIQUES**

Fibra de vidrio / Fiberglass / Fibre en verre

COD.	MAT.	L (mm)	g
36013	Lat / Brass	330	205
36014		350	370



**CARACTERÍSTICAS / FEATURES / CARACTÉRISTIQUES**

Madera de nogal / Hickory wood / Bois de noyer

**MACETA DE LATÓN / BRASS MALLET / MASSETTE LAITON / MESSINGHAMMER / MAZZETTA DI OTTONE / MAÇO DE LATAO COM CABO DE FIBRA DE VIDRO / БРОНЗОВАЯ КУВАЛДА**

COD.	MAT.	L (mm)	g
72796	Lat / Brass	900	4500
72797			5400
72798			7650



**CARACTERÍSTICAS / FEATURES / CARACTÉRISTIQUES**

Fibra de vidrio / Fiberglass / Fibre en verre

COD.	MAT.	L (mm)	g
36015	Lat / Brass	800	4500
36016			5400
36017			7650



**CARACTERÍSTICAS / FEATURES / CARACTÉRISTIQUES**

Madera de nogal / Hickory wood / Bois de noyer

**MACETA DE COBRE / COPPER MALLET / MASSETTE CUIVRE / KUPFERHAMMER / MAZZETTA DI RAME / MARRETA DE COBRE COM CABO DE FIBRA DE VIDRO / МЕДНАЯ КУВАЛДА**

COD.	MAT.	L (mm)	g
72799	Cu	350	1350



**CARACTERÍSTICAS / FEATURES / CARACTÉRISTIQUES**

Fibra de vidrio / Fiberglass / Fibre en verre

Lat/Brass Latón / Brass / Laiton / Messing / Ottone / Latao / БРОНЗА  
Cu Cobre / Copper / Cuivre / Kupfer / Rame / Cobre / МЕДНАЯ





COD.	MAT.	L (mm)	 g
<b>36018</b>	Cu	350	1350



**CARACTERÍSTICAS / FEATURES / CARACTÉRISTIQUES**

Madera de nogal / Hickory wood / Bois de noyer

**MACETA DE COBRE / SQUARE COPPER MALLET / MASSETTE CUIVRE / KUPFERHAMMER / MAZZETTA DI RAME / MARRETA DE COBRE / КВОДРАТНАЯ МЕДНАЯ КУВАЛДА**

COD.	MAT.	 O.D. mm	L (mm)	A (mm)	B (mm)	C (mm)			 g
<b>69728</b>	Cu	30	240	26	77	29	6		500
<b>69729</b>		35	260	36	88	39	4	•	1000
<b>69730</b>		40	280	41	99	43			1500



**YUNQUE / ANVIL BLOCK / ENCCLUME / AMBOSSBLOCK / INCUDINE / BIGORNA / БЛОК НАОВАЛЬНИ**

COD.	MAT.	COD.	MAT.	 Kg
<b>73734</b>	Cu-Be	<b>73735</b>	Al-Bron	3
<b>73736</b>		<b>73737</b>		5
<b>73738</b>		<b>73739</b>		16



**MALETA DE ALUMINIO PORTAHERRAMIENTAS / ALUMINIUM TOOL CASE / MALLETTE PORTE-OUTILS / ALUMINIUMKOFFER ZUM ROLLEN / VALIGIA PORTAUTENSILI IN ALLUMINO / MALA DE ALUMINIO PORTAFERRAMENTAS / АЛЮМИНИЕВЫЙ ИНСТРУМЕНТАЛЬНЫЙ КЕЙС**

COD.	L x W x H (mm)	 Kg
<b>51055</b>	1350 x 356 x 114	7,5

**ESPECIFICACIONES TÉCNICAS / TECHNICAL SPECIFICATION / DÉTAILS TECHNIQUES**

Cerradura con llave / Key lock / Serrure avec clé	•
Con cierres en zamak / Zinc alloy lockers / Casiers en alliage de zinc	•



COD.	L x W x H (mm)	 Kg
<b>51056</b>	520 x 330 x 152	3,6

**ESPECIFICACIONES TÉCNICAS / TECHNICAL SPECIFICATION / DÉTAILS TECHNIQUES**

Cerradura con llave / Key lock / Serrure avec clé	•
Con cierres en zamak / Zinc alloy lockers / Casiers en alliage de zinc	•

<b>Cu-Be</b>	Cobre berilio / Beryllium copper / Cuiivre beryllium / Kupfer beryllium / Koper beryllium / Rame-berillio / Сплав Медь Бериллий
<b>Al-Bron</b>	Aluminio bronce / Aluminium bronze / Alliage aluminium-bronze / Alliage aluminium-bronze / Aluminium brons / Aluminio bronzo / Сплав Алюминий Бронза
<b>Cu</b>	Cobre / Copper / Cuiivre / Kupfer / Rame / Cobre / МЕДНАЯ

05

**ANTICHISPA**  
**NON-SPARKING**  
**ANTIDÉFLAGRANT**  
**FUNKENFREI**  
**ANTISCINTILLA**  
**ANTI-DEFLAGRANTE**  
**ИСКРОБЕЗОПАСНЫЙ**



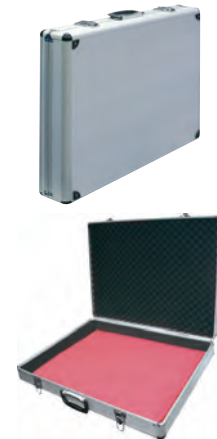

COD.	L x W x H (mm)	
<b>51054</b>	665 x 500 x 110	3,4



**KIT SEGURIDAD ATEX / ATEX SAFETY SETS / KIT DE SÉCURITÉ POUR ZONE ATEX / ATEX SAFETY KIT / KIT SICUREZZA ATEX / JOGO DE SEGURANÇA ATEX / ВЗРЫВОБЕЗОПАСНЫЙ НАБОР**

**8 PCS.**

COD.	PCS.		MAT.	
<b>74386</b>	8	51054	Cu-Be	7,5
<b>74387</b>			Al-Bron	
PCS./UN.	Cu-Be	Al-Bron	Descripción / Description / Description	
1	70474	71624	Espátula / Scraper	50 x 200 mm
	70478	71628		100 x 200 mm
	72157	72162	Raspador plano / Flat scraper	30 x 200 mm
	73422	73399	Rasqueta triangular / Triangular scraper	360 mm
	73785	73786	Pico y rasqueta / Scraper pick and scaler	75 x 450 mm
	71562	71566	Rasqueta / Scraper	60 x 185 mm
	73767	73768	Raspador curvo / Arched scraper	100 x 210 mm
	61581	61581	Cepillos / Brushes	4 x 16 x 240 mm



**15 PCS.**

COD.	PCS.		MAT.	
<b>74382</b>	15	50995	Cu-Be	10
<b>74383</b>			Al-Bron	
PCS./UN.	Cu-Be	Al-Bron	Descripción / Description / Description	
1	70474	71624	Espátula / Scraper	50 mm
	70111	70541	Tenazas Pico Loro / Groove joint pincers	12"
	72458	72459	Tijeras de hojalatero / Tin snips	300 mm
	70117	71452		8"
	70119	71454	Llaves ajustables / Adjustable wrenches	12"
	72452	72453	Llave taponadora universal / Multi-head bung wrench	-
	70102	70532	Alicate universal / Combination pliers	200 mm
	70106	70536	Alicate telefonista / Long nose plier	
	70526	71781	Martillo de uña / Claw hammer	338 mm
	61581	61581	Cepillos / Brushes	4 x 16 x 240 mm
	71613	71614	Cuchillos / Knives	250 mm
	73747	73749	Raspador / Scraper	48 x 300 mm
	71597	71601	Destornillador Philips PH3	
	71585	71592	Destornillador electricista / Electrician screwdriver	8 x 150 mm
	70124	71461	Llave Heavy Duty / Heavy Duty pipe wrench	14"



**Cu-Be** Cobre berilio / Beryllium copper / Cuivre beryllium / Kupfer beryllium / Koper beryllium / Rame-berillio / Сплав Медь Бериллий  
**Al-Bron** Aluminio bronce / Aluminium bronze / Alliage aluminium-bronze / Alliage aluminium-bronze / Aluminium brons / Aluminio bronzo / Сплав Алюминий Бронза

Si no encuentra el artículo que necesita, consúltenos en [info@egamaster.com](mailto:info@egamaster.com) o en [www.egamaster.com](http://www.egamaster.com)  
 If you can't find the item you look for, please ask us in [info@egamaster.com](mailto:info@egamaster.com) or in [www.egamaster.com](http://www.egamaster.com)  
 Si vous ne trouvez pas l'article que vous désirez, consultez-nous a [info@egamaster.com](mailto:info@egamaster.com) ou a [www.egamaster.com](http://www.egamaster.com)

**EGAMaster**  
 ART IN INNOVATION

05

**ANTICHISPA  
NON-SPARKING  
ANTIDÉFLAGRANT  
FUNKENFREI  
ANTISCINTILLA  
ANTI-DEFLAGRANTE  
ИСКРБЕЗОПАСНЫЙ**



Management  
System  
ISO 9001:2015  
ISO 14001:2015  
www.tuc.com  
ID 091058046



## 16 PCS.

COD.	PCS.		MAT.	
<b>74896</b>	16	50995	Cu-Be	10
<b>74897</b>			Al-Bron	

PCS./UN.	Cu-Be	Al-Bron	Descripción / Description / Description	
	70474	71624	Espátula / Scraper	50 mm
	70111	70541	Tenazas Pico Loro / Groove joint pincers	12"
	72458	72459	Tijeras de hojalatero / Tin snips	300 mm
	70117	71452	Llaves ajustables / Adjustable wrenches	8"
	70119	71454	Llave taponadora universal / Multi-head bung wrench	12"
	72452	72453	Llave taponadora universal / Multi-head bung wrench	-
1	70102	70532	Alicate universal / Combination pliers	200 mm
	70106	70536	Alicate telefonista / Long nose plier	
	70526	71781	Martillo de uña / Claw hammer	338 mm
	61581	61581	Cepillos / Brushes	4 x 16 x 240 mm
	71613	71614	Cuchillos / Knives	250 mm
	73747	73749	Raspador / Scraper	48 x 300 mm
	71597	71601	Destornillador Philips / Philips screwdriver	PH3
	71585	71592	Destornillador electricista / Electrician screwdriver	8 x 150 mm
	70124	71461	Llave Heavy Duty / Heavy Duty pipe wrench	14"
	79596	79596	Linterna LED MasterEx / MasterEx LED torch	-



## 17 PCS.

COD.	PCS.		MAT.	
<b>74388</b>	17	50994	Cu-Be	3,6
<b>74389</b>			Al-Bron	

PCS./UN.	Cu-Be	Al-Bron	Descripción / Description / Description	
	70104	70534	Alicate boca redonda / Round nose plier	160 mm
	70103	70533	Alicate boca plana / Flat nose plier	
	70107	70537	Alicate corte diagonal / Diagonal cutting plier	
	70100	70530	Alicate universal / Combination pliers	
	70115	70547	Pinza boca fina / Neat tip tweezer	-
	73903	73904	Pelacables / Wirestripper	170 mm
	71448	71451	Llaves ajustables / Adjustable wrenches	6"
1	72260	72281	Destornillador mecánico / Slotted screwdriver	3 x 75 mm
	72263	72284	Destornillador mecánico / Slotted screwdriver	4 x 100 mm
	72267	72288	Destornillador mecánico / Slotted screwdriver	6 x 150 mm
	72909	72910	Destornillador Philips / Philips screwdriver	PH0
	71595	71599	Destornillador philips / Philips screwdriver	PH1
	70410	70410	Llave hexagonal de bola / Ballpoint hexagonal keys	3 mm
	70411	70411	Llave hexagonal de bola / Ballpoint hexagonal keys	4 mm
	70412	70412	Llave hexagonal de bola / Ballpoint hexagonal keys	5 mm
	70413	71614	Cuchillos / Knives	250 mm
	70529	70546	Tijeras / Scissors	225 mm





**Cu-Be** Cobre berilio / Beryllium copper / Cuivre beryllium / Kupfer beryllium / Koper beryllium / Rame-berillio / Сплав Медь Бериллий  
**Al-Bron** Aluminio bronce / Aluminium bronze / Alliage aluminium-bronze / Alliage aluminium-bronze / Aluminium brons / Aluminio bronzo / Сплав Алюминий Бронза

COD.	PCS.		MAT.	
<b>74390</b>	17	51055	Cu-Be	23
<b>74391</b>			Al-Bron	
PCS./UN.	Cu-Be	Al-Bron	Descripción / Description / Description	
	71576	71577	Barra de desancofrar / Wrecking bar	19 x 900 mm
	70118	71453		10"
	70119	71454	Llaves ajustables / Adjustable wrenches	12"
	70120	71455		15"
	70489	71744		310 mm
	70491	71746	Martillo de bola / Ball pein hammer	350 mm
	70519	71774	Pico de calderero / Chipping hammer	355 mm
	70505	71760	Maceta octogonal / Sledge hammer	900 mm
1	73747	73749	Raspador / Scraper	48 x 300 mm
	73767	73768	Raspador curvo / Arched scraper	100 x 210 mm
	72272	72293		10 x 200 mm
	72273	72294	Destornillador / Screwdriver	10 x 300 mm
	73815	73816	Cortafíos hexagonal / Hexagonal chisel	18 x 160 mm
	73798	73799	Cortafíos cilíndrico / Cylindrical chisel	24 x 250 mm
	70121	71458		8"
	70122	71459	Llave Heavy Duty / Heavy Duty pipe wrench	10"
	70124	71461		14"





## 20 PCS.

COD.	PCS.		MAT.	
<b>74380</b>	20	50994	Cu-Be	8
<b>74381</b>			Al-Bron	
PCS./UN.	Cu-Be	Al-Bron	Descripción / Description / Description	
	70124	71461	Llave Heavy Duty / Heavy Duty pipe wrench	14"
	70174	70686		10 mm
	70175	70687		11 mm
	70176	70688		12 mm
	70177	70689	Llaves combinadas / Combination wrenches	13 mm
	70178	70690		14 mm
	70181	70693		17 mm
	70183	70695		19 mm
	70186	70698		22 mm
1	71596	71600	Destornillador Philips / Philips screwdriver	PH2
	71585	71592	Destornillador electricista / Electrician screwdriver	8 x 150
	70118	71453	Llaves ajustables / Adjustable wrenches	10"
	70102	70532	Alicate universal / Combination pliers	200 mm
	70106	70536	Alicate telefonista / Long nose plier	200 mm
	70526	71781	Martillo de uña / Claw hammer	338 mm
	61581	61581	Cepillos / Brushes	4 x 16 x 240 mm
	73747	73749	Raspador / Scraper	48 x 300 mm
	70472	71622	Espátula / Scraper	30 mm x 200 mm
	71613	71614	Cuchillos / Knives	250 mm
	70110	70540	Tenazas Pico Loro / Groove joint pincers	10"



■ 37 PCS.

COD.	PCS.		MAT.	
<b>74384</b>	37	50995	Cu-Be	13
<b>74385</b>			Al-Bron	
PCS./UN.	Cu-Be	Al-Bron	Descripción / Description / Description	
	70174	70686		10 mm
	70175	70687		11 mm
	70176	70688		12 mm
	70177	70689		13 mm
	70178	70690	Llaves combinadas / Combination wrenches	14 mm
	70179	70691		15 mm
	70181	70693		17 mm
	70183	70695		19 mm
	70186	70698		22 mm
	70188	70700		24 mm
	70110	70540	Tenazas Pico Loro / Groove joint pincers	10"
	71613	71614	Cuchillos / Knives	250 mm
	70474	71624	Espátula / Scraper	50 mm
	61581	61581	Cepillos / Brushes	4 x 16 x 240 mm
	70391	71287		2 mm
	70392	71288		3 mm
	70393	71289		4 mm
	70394	71290	Llave hexagonal / Hex pipe wrench	5 mm
	70395	71291		6 mm
	70397	71293		8 mm
	70399	71295		10 mm
	70102	70532	Alicate universal / Combination pliers	200 mm
	70107	70537	Alicate de corte diagonal / Diagonal cutting plier	160 mm
	70129	71466	Llave sueca / Swedish pipe wrench	45° 1.1/2"
	70118	71453		10"
	70119	71454	Llaves ajustables / Adjustable wrenches	12"
	70497	71752	Martillo alemán / German type machinist's hammer	310 mm
	70513	71768	Maceta cuadrada / Stoning hammer	2 Kg (400 mm)
	72306	72308	Destornillador electricista / Electrician screwdriver	5 x 100 mm
	71585	71592		8 x 150 mm
	71595	71599	Destornillador Philips / Philips screwdriver	PH1
	71597	71601		PH3
	73796	73797	Cortafrio cilíndrico / Cylindrical chisel	20 x 200 mm
	73780	73781	Cinzel en punta / Cross cutting chisel	200 mm
	70429	71475	Botador / Pin punch	5 mm, 150 x 10 mm
	70434	71480		10 mm, 150 x 14
	70529	70546	Tijeras / Scissors	225 mm



05

**ANTICHISPA  
NON-SPARKING  
ANTIDÉFLAGRANT  
FUNKENFREI  
ANTISCINTILLA  
ANTI-DEFLAGRANTE  
ИСКРОБЕЗОПАСНЫЙ**



## 38 PCS.

COD.	PCS.		MAT.	
74898	38	50995	Cu-Be	13
74899			Al-Bron	



PCS./UN.	Cu-Be	Al-Bron	Descripción / Description / Description	
	70174	70686		10 mm
	70175	70687		11 mm
	70176	70688		12 mm
	70177	70689		13 mm
	70178	70690	Llaves combinadas / Combination wrenches	14 mm
	70179	70691		15 mm
	70181	70693		17 mm
	70183	70395		19 mm
	70186	70698		22 mm
	70188	70700		24 mm
	70110	70540	Tenazas Pico Loro / Groove joint pliers	10"
	71613	71614	Cuchillos / Knives	250 mm
	70474	71624	Espátula / Scraper	50 mm
	61581	61581	Cepillos / Brushes	4 x 16 x 240 mm
	70391	71287		2 mm
	70392	71288		3 mm
	70393	71289		4 mm
	70394	71290	Llave hexagonal / Hex pipe wrench	5 mm
	70395	71291		6 mm
	70397	71293		8 mm
	70399	71295		10 mm
	70102	70532	Alicata universal / Combination pliers	200 mm
	70107	70537	Alicata de corte diagonal / Diagonal cutting plier	160 mm
	70129	71466	Llave sueca / Swedish pipe wrench	45° 1.1/2"
	70118	71453		10"
	70119	71454	Llaves ajustables / Adjustable wrenches	12"
	70497	71752	Martillo alemán / German type machinist's hammer	310 mm
	70513	71768	Maceta cuadrada / Stoning hammer	2 Kg (400 mm)
	72306	72308	Destornillador electricista / Electrician screwdriver	5 x 100 mm
	71585	71592		8 x 150 mm
	71595	71599	Destornillador Philips / Philips screwdriver	PH1
	71597	71601		PH3
	71596	73797	Cortafrio cilíndrico / Cylindrical chisel	20 x 200 mm
	73780	73781	Cíncel en punta / Cross cutting chisel	200 mm
	70429	71475	Botador / Pin punch	5 mm, 150 x 10 mm
	70434	71480		10 mm, 150 x 14 mm
	70529	70546	Tijeras / Scissors	225 mm
	79596	79596	Linterna LED MasterEx / MasterEx LED torch	-

**Cu-Be** Cobre berilio / Beryllium copper / Cuivre beryllium / Kupfer beryllium / Koper beryllium / Rame-berillio / Сплав Медь Бериллий  
**Al-Bron** Aluminio bronce / Aluminium bronze / Alliage aluminium-bronze / Alliage aluminium-bronze / Aluminium brons / Aluminio bronzo / Сплав Аллюминий Бронза

Si no encuentra el artículo que necesita, consúltenos en [info@egamaster.com](mailto:info@egamaster.com) o en [www.egamaster.com](http://www.egamaster.com)  
 If you can't find the item you look for, please ask us in [info@egamaster.com](mailto:info@egamaster.com) or in [www.egamaster.com](http://www.egamaster.com)  
 Si vous ne trouvez pas l'article que vous desirez, consultez-nous a [info@egamaster.com](mailto:info@egamaster.com) ou a [www.egamaster.com](http://www.egamaster.com)

**EGAMaster**  
ART IN INNOVATION

**ACETILEX: ALEACIÓN ACETILEX, TRABAJO SEGURO INCLUSO EN AMBIENTES DE ACETILENO / ACETILEX ALLOY, SAFE WORK EVEN IN ACETYLENE ENVIRONMENTS / ALLIAGE ACETILEX, TRAVAIL SÛR MÊME EN PRÉSENCE D'ACÉTHYLÈNE / SICHERE ARBEIT SOGAR BEI ACETYLEN-ATMOSPHÄREN / LEGA ACETILEX, LAVORO SICURO ANCHE IN AMBIENTI DI ACETILENO / LIGA ACETILEX, TRABALHO SEGURO INCLUSIVÉ EM AMBIENTES ACETILENO / СПЛАВ АЦИТИЛЕКС, БЕЗОПАСНАЯ РАБОТА ДАЖЕ В СРЕДЕ АЦИТИЛЕНА**

**TENAZA PICO DE LORO / GROOVE JOINT PLIER / MULTIPRISE À CRÉMAILLÈRE / VERSTELLBARE WASSERPUMPZANGE / POLIGRIP / ALICATE BICO DE PAPAGAIO / КЛЕЩИ ПЕРЕСТАВНЫЕ ЖЕЛОБКОВЫЕ**

COD.	L (inch)	
79450	10	430
79451	12	670



ACETILEX



**LLAVE AJUSTABLE / ADJUSTABLE WRENCH / CLÉ À MOLETTE / ROLLGABELSCHLÜSSEL / CHIAVI REGOLABILI A RULLINO / CHAVE AJUSTAVEL / РАЗВОДНЫЕ КЛЮЧИ**

COD.	L (inch)	
79452	6	135
79453	8	280
79454	10	440
79455	12	720



ACETILEX

**LLAVE HEAVY DUTY / HEAVY DUTY PIPE WRENCH / CLÉ SERRE-TUBES H.D. / EINHAND-ROHRZANGEN / GIRATUBI MODELLO AMERICANO PESANTE / CHAVE HEAVY DUTY / ТРУБНЫЙ КЛЮЧ ДЛЯ ТЯЖЕЛЫХ РАБОТ**

COD.	L (inch)		
79456	8"	1	420
79457	10"	1.1/2"	740
79458	12"	2	1050
79459	14"		1320
79460	18"	2.1/2"	2260
79461	24"	5	3470
79462	36"	6	5880





ACETILEX

**LLAVES / WRENCHES / CLÉS / SCHLÜSSEL / CHIAVI / CHAVES / КЛЮЧИ**

**LLAVES COMBINADAS / COMBINATION WRENCHES / CLÉS MIXTES / RINGSCHLÜSSEL / CHIAVI COMBINATE / CHAVES BOCA E LUNETAS / КОМБИНИРОВАННЫЕ КЛЮЧИ**

MM

COD.		L (mm)	
72867	6	115	36
72868	7	120	43
72869	8	125	50
72870	9	130	65
72871	10	135	70
72872	11	140	75
72873	12	145	95
72874	13	155	105
72875	14	165	110
72876	15	175	120
72877	16	185	165
72878	17	195	175
72879	18	200	210
72880	19	210	220
72881	20	220	250
72882	21	230	270
72883	22	240	290
72884	23	250	370
72885	24	260	400
72886	25		420
72887	26	270	440
72888	27	280	500





05

**ANTICHISPA  
NON-SPARKING  
ANTIDÉFLAGRANT  
FUNKENFREI  
ANTISCINTILLA  
ANTI-DEFLAGRANTE  
ИСКРОБЕЗОПАСНЫЙ**



COD.	AF mm	L (mm)	g
72889	28	295	550
72890	29	300	650
72891	30	310	700
72892	32	330	800

ACETILEX

■ **FIJA DE GOLPE / SLOGGING OPEN WRENCH / À FOURCHE À FRAPPER / SCHLAG MAULSCHLÜSSEL / FISSE AD IMPULSO / BOCA DE IMPACTO / УДАРНЫЙ РОЖКОВЫЙ КЛЮЧ**

■ MM

COD.	AF mm	L (mm)	g
72901	30	185	450
72902	32	195	550
72903	36	210	750
72904	41	220	1000
72905	46	240	1300
72906	50	250	1400
72907	55	270	1750
72908	60	280	2000

ACETILEX



■ **ESTRELLA DE GOLPE / SLOGGING RING / POLYGONALE À FRAPPER / SCHLAG RINGSCHLÜSSEL / POLIGONALE AD IMPULSO / LUNETTA DE IMPACTO / УДАРНЫЙ КЛЮЧ ЗВЕЗДОЧКА**

■ MM

COD.	AF mm	L (mm)	g
72893	30	165	420
72894	32	175	490
72895	36	210	600
72896	41	220	850
72897	46	240	1050
72898	50	250	1200
72899	55	260	1400
72900	60	270	1700

ACETILEX



■ **LLAVES HEXAGONALES / HEXAGONAL KEYS / CLÉS MALES / INBUSSCHLÜSSEL / CHIAVI ESAGONALI / CHAVES HEXAGONAIS / ШЕСТИГРАННИК**

■ MM

COD.	AF mm	L (mm)	H (mm)	g
72856	2	38	13	7,0
72857	3	59	25	9,0
72858	4	65	30	11
72859	5	79	32	18
72860	6	85	37	28
72861	7	88	43	37
72862	8	92	44	55
72863	9	97		65
72864	10	110	45	90
72865	11	119	48	125
72866	12	130	52	160

ACETILEX





05

**ANTICHISPA  
NON-SPARKING  
ANTIDÉFLAGRANT  
FUNKENFREI  
ANTISCINTILLA  
ANTI-DEFLAGRANTE  
ИСКРОБЕЗОПАСНЫЙ**

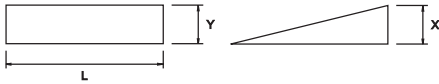

### ■ CUÑA / WEDGE / COIN / KEIL / CUNEO / СУННА / КЛИН







COD.	L (mm)	X (mm)	Y (mm)	 g
72851	100	10-0	50	210
72852	150	13-0		420
72853	180	19-0		750
72854	200	12-0		500
72855	230	20-0		800

ACETILEX



### ■ DESTORNILLADORES / SCREWDRIVERS / TOURNEVIS / SCHRAUBENZIEHER / CACCIAVITI / CHAVES DE FENDA / ОТВЕРТКИ





#### ■ ELECTRICISTA / ELECTRICIAN / ELECTRICIEN / ELEKTRIKER / PER ELETTRICISTI / ELETTRICISTA / ЭЛЕКТРИЧЕСКАЯ

COD.	 mm	 mm	 mm	 g
72825	50	3	83	41
72826	100	4	103	50
72827		5		105
72828	150	6	112	115
72829		8		160

ACETILEX







#### ■ PHILIPS

COD.	 mm		 mm	 g
72830	60	PH-0	83	44
72831	80	PH-1	103	75
72832	100	PH-2		85
72833	150	PH-3	112	180

ACETILEX



#### ■ POZIDRIV®\*

COD.	 mm		 mm	 g
72835	75	PZ-1	83	50
72836	100	PZ-2	103	95
72837	150	PZ-3	112	160

ACETILEX



### ■ MARTILLOS / HAMMERS / MARTEAUX / HÄMMER / MARTELLI / MARTELOS / МОЛОТКИ И КУВАЛДЫ

#### ■ MARTILLO DE BOLA / BALL PEIN HAMMER / MARTEAU À BOULE / SCHLOSSER HAMMER / MARTELLO A PALLA / MARTELO DE BOLA / МОЛОТОК С ШАРОВОЙ ГОЛОВКОЙ

COD.	L (mm)	 g
72838	310	500
72839	340	680
72840	350	900

ACETILEX



#### ■ MARTILLO ALEMÁN / GERMAN TYPE MACHINIST'S HAMMER / MARTEAU DE MECANICIEN / SCHLOSSER HAMMER / MARTELLO TEDESCO / MARTELO TIPO ALEMÃO / СЛЕСАРНЫЙ МОЛОТОК НЕМЕЦКИЙ ТИП

COD.	L (mm)	 g
72841	310	500
72842	340	800
72843		1000

ACETILEX



\* Para tornillos POZIDRIV® (Marca registrada por European Ind. Serv. Ltd.) / \*For screws POZIDRIV® (European Ind. Serv. Ltd. registered trademark) / \*Pour vis POZIDRIV® (Marque enregistrée par European Ind. Serv. Ltd.)

MACETA OCTOGONAL / SLEDGE HAMMER / MASSE OCTOGONALE / SCHLAGHAMMER / MAZZETTA OTTOGONALE / MARRETA OCTOGONAL / КУВАЛДА КУЗНЕЧНАЯ

COD.	L (mm)	g
72844		1000
72845	400	1500
72846		2000
72847		3000
72848	900	4000
72849		5000

ACETILEX



PICO DE CALDERERO / CHIPPING HAMMER / PÏOCHE DE CHAUDRONNIER / KESSELSTEINHAMMER / PICCONE DA BATTIRAME / PICADEIRA DE CALDEIREIRO / МОЛОТОК ВЫРУБНОЙ

COD.	L (mm)	g
72850	280	400

ACETILEX





## **ENGIE (México)**

*José Ángel Lázaro*  
Jefe de Sector/Mantenimiento SLP

"Hemos confiado en EGA Master como proveedor de nuestra herramienta anti-chispa debido a la alta calidad de sus productos. Además de ser un proveedor de confianza que nos ofrece el mayor servicio que hemos encontrado en nuestra industria. La seguridad es muy importante para nosotros y a través de EGA Master tenemos acceso a las soluciones que necesitamos para apalancar la seguridad y productividad de nuestros empleados en las diferentes líneas de negocio."

**ATEX**

SEGURIDAD INTRÍNSECA  
INTRINSIC SAFETY  
SÉCURITÉ INTRINSÈQUE  
EXSCHUTZ  
SICUREZZA INTRINSECA  
SEGURANÇA INSTRINSECA  
ВЗРЫВОБЕЗОПАСНЫЙ

6



**ATEX**

**DESIGNACIÓN Ex**  
**Ex DESIGNATION**  
**DÉSIGNATION Ex**
**ATEX**
**Atmósfera - Explosiva**
**Directiva 2014/34/UE**

Articula las disposiciones legales a tomar por los estados miembros para los aparatos y sistemas de protección diseñados para su uso en áreas potencialmente explosivas.

Nuevo: ATEX 114 (Antiguo: ATEX 95).

**Directiva 1999/92/CE**

Requerimientos mínimos para la mejora de la salud y la seguridad del trabajador en peligro ante atmósferas explosivas.

Nuevo: ATEX 153 (Antiguo: ATEX 137).

**ATEX**
**Explosive - Atmosphere**
**2014/34/UE Directive**

Harmonises legal provisions of member states for devices and protection systems for designated use in potentially explosive areas.

New: ATEX 114 (Old: ATEX 95).

**1999/92/CE Directive**

Minimum requirements for improving the health and safety protection of the worker at risk from explosive atmospheres.

New: ATEX 153 (Old: ATEX 137).

**ATEX**
**Atmosphère - Explosive**
**Directive 2014/34/UE**

Coordonne les dispositions légales à prendre dans les états membres pour les appareils et les systèmes de protection dessinés pour une utilisation dans des aires potentiellement explosives.

Nouveau: ATEX 114 (Ancien: ATEX 95).

**Directive 1999/92/CE**

Exigences minimum pour l'amélioration de la santé et de la sécurité du travailleur en danger dans des atmosphères explosives.

Nouveau: ATEX 153 (Ancien: ATEX 137).

**Ejemplos de denominación: / Designation examples: / Exemples de désignations:**

- Uso en atmósferas gaseosas / Use in gaseous atmospheres / Utilisation en atmosphères gazeuses: ☉ **II 1 G EEx ia IIC T4**
- Uso en atmósferas de polvo / Use in dusty atmospheres / Utilisation en atmosphères poussiéreuses: ☉ **II 2 D T90°C IP64**
- Uso para aplicaciones de minería / Use for minig applications / Application pour des utilisations: ☉ **I M2 EEx ia I**

**Indicación de que el producto es apto para su uso en ambientes explosivos**

*Indication of the suitability of the product in explosive environments*

**Indication que le produit est apte pour son utilisation dans des environnements explosifs**

**Grupo de aparatos**

*Device group*

**Groupe d'appareils**

- I Minería / Mining / Minière
- II Todas las demás áreas explosivas / All other explosive areas / Tout le reste des zones explosives

**Categoría**

*Category*

**Catégorie**

- 1 Zonas / Zones / Zones: 0/20
- 2 Zonas / Zones / Zones: 1/21
- 3 Zonas / Zones / Zones: 2/22
- M1 Minería (en caso de grisú es posible seguir trabajando)  
*Mining (in case of firedamp, continuation of operation is possible)*  
Minier (en cas de grisou, le travail peut continuer)
- M2 Minería (en caso de grisú debe apagarse)  
*Mining (must be switched off in case of firedamp)*  
Minier (en cas de grisou, on doit l'éteindre)

**Atmósfera**

*Atmosphere*

**Atmosphère**

- G Gas / Gas / Gaz
- D Polvo / Dust / Poussière  
*(Mining - No details)*

**II 1 GD**
**EEx**
**ia**
**IIC**
**T4**
**T90°C**
**IP64**
**Tipos de protección frente a la ignición**

*Types of ignition protection*

**Types de protections face à l'ignition**

- o Inmersión en aceite / Oil immersion / Immersion dans l'huile
- p Presurización / Pressurisation / Prèssurisation
- q Relleno de polvo / Powder filling / Rempli de poussière
- d Carcasa resistente a la presión / Pressure-proof housing / Carcasse résistante à la pression
- e Aumento de seguridad / Increased safety / Augmentation de la sécurité
- ia Seguridad intrínseca (requerida para la Zona 0\*)  
\* Depend de la categoría del aparato  
*Intrinsic safety (required for Zone 0\*)*  
\* depends on device category  
Sécurité intrinsèque (recommandé pour la zone 0\*)  
\* Dépend de la catégorie d'appareil
- ib Seguridad intrínseca (adecuada para la Zona 1 (+2))  
*Intrinsic safety (adequate for Zone 1 (+2))*  
Sécurité intrinsèque (adéquat pour les zones 1 (+2))
- m Encapsulado / Encapsulation / Capsulé
- s Protección especial / Special protection / Protection spéciale
- n Funcionamiento normal bajo condiciones normales (sólo para la Zona 2)  
*Normal operation under normal conditions (for Zone 2 only)*  
Fonctionnement normal en conditions normales (uniquement zone 2)
- nA Antichispa / Non-sparking / Anti-déflagrant
- nC Contactos protegidos / Protected contacts / Contacts protégés
- nR Carcasa resistente al vapor / Vapour-proof housing / Carcasse résistante à la vapeur
- nL Energía limitada / Limited energy / Énergie limitée
- nP Simplificada / Simplified / Simplifiée

**Clases de temperatura**

*Temperature classes*

**Classes de température**

(Máxima temperatura de una superficie en la que el gas puede penetrar en el caso de fallo del aparato. No debería usarse en las zonas Ex de polvo.)

*(Max. temperature of a surface that gas can penetrate in the event of device failure. Should not be used in dust-ex-markings.)*

(Température maximum d'une surface dans laquelle le gaz peut pénétrer lors d'une défaillance de l'appareil. Ne doivent pas être utilisés dans les zones Ex de poussière.)

- T1 450 °C
- T2 300 °C
- T3 200 °C
- T4 135 °C
- T5 100 °C
- T6 85 °C

**Grupo de explosión**

*Explosion group*

**Groupe d'explosion**

(Dato facilitado para los aparatos usados en las áreas definidas como potencialmente explosivas por gas.)

*(Data only for devices used in areas rendered potentially explosive by gas.)*

(Renseignements donnés pour les appareils utilisés dans les aires définies comme potentiellement explosives au gaz.)

- I Metano (minería) / Methane (mining) / Méthane (mines)
- IIA Propano / Propane / Propane
- IIB Etileno / Ethylene / Ethylène
- IIC Grupo más peligroso (e.j. hidrógeno) / Most dangerous group (e.g. hydrogen) / Groupe plus dangereux (e.x. hydrogène)

## T90°C

### Máxima temperatura superficial Max. surface temperature Température maximum en surface

(Dato facilitado para los aparatos usados en las áreas definidas como potencialmente explosivas por polvo - raramente también utilizado en las gaseosas.)

(Data for devices used in areas rendered potentially explosive by dust - rarely also used in gas ex marking.)

(Renseignément donné pour les appareils utilisés dans les aires définies comme potentiellement explosives par la poussière et rarement utilisés dans des aires gazeuses.)

Máxima temperatura de una superficie en caso de fallo del aparato (o durante su uso normal en los aparatos de categoría 3) que puede ser alcanzada en una atmósfera Ex.

#### Evaluación por el usuario:

- Temperatura límite 1 = 2/3 de la temperatura mínima de ignición del polvo presente.
- Temperatura límite 2 = mínima temperatura de quemado del polvo presente menos 75 K (grados Kelvin) (se aplica para capas de polvo de espesores de hasta 5 mm).

El valor más pequeño de los límites de temperatura debe estar por encima de la máxima temperatura superficial indicada para el aparato.

Maximum temperature of a surface during a machine error (normal operation in the case of category 3 devices) that can be reached by the ex atmosphere.

#### Evaluation by the user:

- Limit temperature 1 = 2/3 of min. ignition temperature of dust present
- Limit temperature 2 = min. glow temperature of dust present minus 75k (applies for layer thicknesses of up to 5mm)

The smaller value for the limit temperature must be above the indicated max. surface temperature of the device.

Température maximale d'une surface qui peut être atteinte dans une atmosphère Ex. dans le cas d'une défaillance d'un appareil (ou durant son utilisation normale dans les machines de catégorie 3)

#### Evaluation par l'utilisateur:

- Température limite 1 = 2/3 de la température minimum d'ignition de la poussière présente
- Température limite 2 = température minimum de brûlure de la poussière présente moins de 75k (degrés Kelvin) (elle s'applique pour des couches de poussières jusqu'à 5mm)

La valeur la plus basse de température doit être au-dessus de la température maximale superficielle indiquée pour l'appareil.



## IP64

### Código IP IP Code Code IP

(Dato facilitado sólo para aparatos usados en las áreas definidas como potencialmente explosivas por polvo.)

(Data only for devices used in areas rendered potentially explosive by dust.)

(Renseignément donné uniquement pour les appareils utilisés dans des aires définies comme potentiellement explosives par la poussière.)

#### Figura 1. Protección contra el contacto y cuerpos extraños:

- Protección contra depósitos de polvo
- Protección contra penetración de polvo

#### Figura 2. Protección contra el agua:

Protección contra:

- (No protección)
- Goteo vertical de agua
- Goteo de agua sobre aparato en funcionamiento inclinado 15°
- Agua pulverizada
- Agua pulverizada
- Chorro de agua
- Fuerte chorro de agua
- Inmersión temporal
- Inmersión continua

#### Figure 1. Contact and foreign body protection:

- Protection against dust deposits
- Protection against dust penetration

#### Figure 2. Water protection

Protection against:

- (No protection)
- Vertically falling drip water
- Drip water on operating device inclined to 15° 3=spray water
- Spray water
- Spray water
- Jet water
- Strong jet water
- Temporary immersion
- Continuous immersion

#### Figure 1. Protection contre le contact et les corps étrangers:

- Protection contre les dépôts de poussière
- Protection contre la pénétration de poussière

#### Figure 2. Protection contre l'eau

Protection contre:

- (Pas de protection)
- Goutte verticale
- Gouttes d'eau avec une inclinaison de 15° sur un appareil en fonctionnement
- Eau pulvérisée
- Eau pulvérisée
- Jet d'eau
- Jet d'eau puissant
- Immersion temporaire
- Immersion continue

## DESIGNACIÓN Ex Ex DESIGNATION DÉSIGNATION Ex

### Protección frente a la explosión

Los principales principios para una segura e íntegra protección frente a la explosión son los siguientes:

1. Tomar medidas para evitar las atmósferas Ex siempre que sea posible.
2. Tomar medidas que prevengan la ignición de atmósferas Ex.
3. Tomar medidas que limiten los efectos de la explosión hasta un grado seguro.

### Esto se diferencia de:

#### Protección primaria frente a la explosión:

Tomar precauciones para prevenir o restringir la formación de atmósferas Ex explosivas.

#### Protección secundaria frente a la explosión:

Éste abarca el segundo grupo de medidas, las cuales tienen la intención de prevenir la ignición de una atmósfera capaz de explotar.

### Explosion Protection

The important principles for integrated safety explosion protection are as follows:

1. Measures are taken to avoid hazardous atmospheres whenever possible.
2. Measures are taken which prevent the ignition of hazardous atmospheres.
3. Measures are taken which limit the explosive effect to a safe degree.

### This differs from:

#### Primary explosive protection:

These are precautions taken to prevent or restrict the formation of hazardous explosive atmospheres.

#### Secondary explosive protection:

This covers the second group of measures, which are intended to prevent the ignition of an atmosphere that is capable of exploding.

### Protection contre l'explosion

Los principios más importantes para una protección sûre et entière contre l'explosion sont les suivants:

1. Adopter les mesures nécessaires pour éviter tant que possible la zone Ex
2. Prendre les mesures de prévention contre l'ignition en atmosphère Ex
3. Prendre les mesures qui limitent les effets de l'explosion à un niveau nul

### Celá se différencie de:

#### La protection primaire contre l'explosion:

Prendre des précautions pour prévenir ou réduire la formation d'atmosphères Ex explosives

#### La protection secondaire contre l'explosion:

Celui-ci comprend le second groupe de moyens, ceux qui ont l'intention de prévenir l'ignition d'une atmosphère qui peut exploser.

Definición de acuerdo con la Directiva 1999/92/EC (ATEX 153) Definition in accordance with 1999/92/EC Directive (ATEX 153) Définition en accord à la Directive 1999/92/EC (ATEX 153)	Valores de referencia (no estandarizados) Reference values (not standardised) Valeurs de référence (non standardisés)	Zona Zone Zone	Debe usarse un aparato de la siguiente categoría (ver la Directiva 1999/92/EC - ATEX 153) A device from the following device category must be used (see 1999/92/EC-ATEX 153 Directive) On doit utiliser un appareil de la catégorie suivante (Voir la Directive 1999/92/EC - ATEX 153)	e
Área donde con frecuencia o bien durante un largo periodo de tiempo está presente una atmósfera potencialmente explosiva mezcla de aire y gases inflamables, vapores o niebla. / Area in which a potentially explosive atmosphere as a mixture of air and flammable gases, vapours or mists is present either frequently or over a prolonged period. / Aire où fréquemment ou durant une longue période, une atmosphère potentiellement explosive avec un mélange d'air et de gaz inflammable, de vapeurs ou de brouillard, est présente.	P>1000 h/a	0	1	G
Área donde bajo un funcionamiento normal puede formarse ocasionalmente una atmósfera potencialmente explosiva mezcla de aire y gases inflamables, vapores o niebla. / Area in which under normal operation a potentially explosive atmosphere as a mixture of air and flammable gases, vapours or mists can occasionally form. / Aire dans laquelle en conditions normales, peut se former occasionnellement une atmosphère potentiellement explosive avec un mélange d'air et de gaz inflammable, de vapeurs ou de brouillard.	10...1000 h/a	1	2 (1G también posible / also possible / aussi possible)	G
Área donde bajo un funcionamiento normal no se presenta normalmente una atmósfera potencialmente explosiva aunque puede presentarse durante un breve periodo de tiempo. / Area in which under normal operation a potentially explosive atmosphere as a mixture of air and flammable gases, vapours or mists is not normally present but may occur for just a short period. / Aire dans laquelle en conditions normales, il n'y a pas d'atmosphère potentiellement explosive, malgré une possibilité d'apparition sur de courtes durées.	<10 h/a	2	3 (1G, 2G también posible / also possible / aussi possible)	G
Área donde está presente constantemente, durante periodos prolongados o bien con frecuencia, una atmósfera potencialmente explosiva en forma de nube de polvo inflamable. / Area in which a potentially explosive atmosphere in the form of a cloud of flammable air-borne dust is present either constantly, over prolonged periods or frequently. / Aire dans laquelle, une atmosphère potentiellement explosive en forme de nuage de poussière inflammable, est constante ou présente sur de longues durées.	>1000 h/a	20	1	D
Área donde bajo un funcionamiento normal puede formarse una atmósfera potencialmente explosiva en forma de nube de polvo inflamable. / Area in which under normal operation a potentially explosive atmosphere in the form of a cloud of flammable air-borne dust can occasionally form. / Aire dans laquelle, en conditions normales, une atmosphère potentiellement explosive sous forme de nuage de poussières inflammables, peut se former.	10...1000 h/a	21	2 (1D también posible / also possible / aussi possible)	D
Área donde bajo un funcionamiento normal no se presenta normalmente una atmósfera potencialmente explosiva en forma de nube de polvo inflamable aunque puede presentarse durante un breve periodo de tiempo. / Area in which under normal operation a potentially explosive atmosphere in the form of a cloud of flammable air-borne dust is not normally present although may occur for just a short period. / Aire dans laquelle en conditions normales, une atmosphère potentiellement explosive sous forme de nuage de poussières n'est pas présente, mais peut apparaître un bref instant.	<10 h/a	22	3 (1D, 2D también posible / also possible / aussi possible)	D



### División en Clases de Temperatura

La indicación de la clase de temperatura puede garantizarse sólo si se respeta la temperatura ambiente especificada para el aparato en uso (mirar datos técnicos o chapa de características). Su estricto cumplimiento es un requisito obligatorio.

Una vez que la máxima temperatura superficial de cualquier aparato alcance la temperatura de ignición de la atmósfera Ex circundante, puede ocurrir una explosión.

Debido a esto, todo equipo-material clasificado dentro del Grupo II se divide en clases de temperatura. Para tener en cuenta la posibilidad de atmósferas Ex potenciales, la temperatura de ignición más baja debe ser mayor que la máxima temperatura superficial.

### Division into Temperature Classes

The temperature class indication can be guaranteed only if the ambient temperature specified for the operating device is respected (see Technical Data or Rating Plate). Strict compliance is a mandatory requirement.

Once the maximum surface temperature of any apparatus reaches the ignition temperature of the surrounding hazardous atmosphere an explosion can occur.

Because of this, all equipment classified to Group II is divided into temperature classes. To allow for the possibility of potential hazardous atmospheres, the lowest ignition temperature must always be higher than the maximum surface temperature.

### Division en classes de températures

L'indication de la classe de température peut être garantie uniquement si nous respectons la température ambiante, spécifiée pour l'appareil en fonctionnement (voir les renseignements techniques ou la table de caractéristiques). Son application stricte est une obligation.

Quand la température superficielle maximale de tout appareil atteint la température d'ignition de l'atmosphère Ex circulant, il peut se produire une explosion.

C'est pour cela, que tout équipement - matériel classifié dans le Groupe II, est divisé en classes de températures. Pour prendre en compte, la possibilité d'atmosphère Ex potentielle, la température d'ignition la plus basse doit être supérieure à la température maximale superficielle.

Clases de temperatura de gases inflamables y vapores y temperaturas superficiales permitidas del aparato en uso de acuerdo con la DIN EN 50014 Temperature classes of flammable gases and vapours and permitted surface temperatures of the operating device in accordance with DIN EN 50014 Classes de températures de gaz inflammables et de vapeurs et de températures superficielles autorisées pour l'appareil utilisé en accord avec la norme DIN EN 50014						
Clase de temperatura Temperature class Classe de température	T1	T2	T3	T4	T5	T6
Temperatura de ignición (°C) Ignition temperature in °C Température d'ignition (°C)	>450	>300	>200	>135	>100	>85
Máxima temperatura superficial (°C) Maximum temperature in °C Température maximum superficielle (°C)	450	300	200	135	100	85
Ejemplos: Examples: Exemples:	Propano / Propane / Propane Metano / Methane / Méthane Amoniaco / Ammoniac / Ammoniac	Etileno / Ethylene / Ethylène Alcoholes / Alcohols / Alcools Acetileno / Acetylene / Acétylène	Petróleo / Petrol / Pétrole Disolventes / Solvents / Dissolvants	Etiléter / Ethylether / Etiléther Acetaldehído / Acetaldehyde / Acetaldehyde	-	Disulfuro de carbono / Carbon-disulphide / Disulfure de carbone

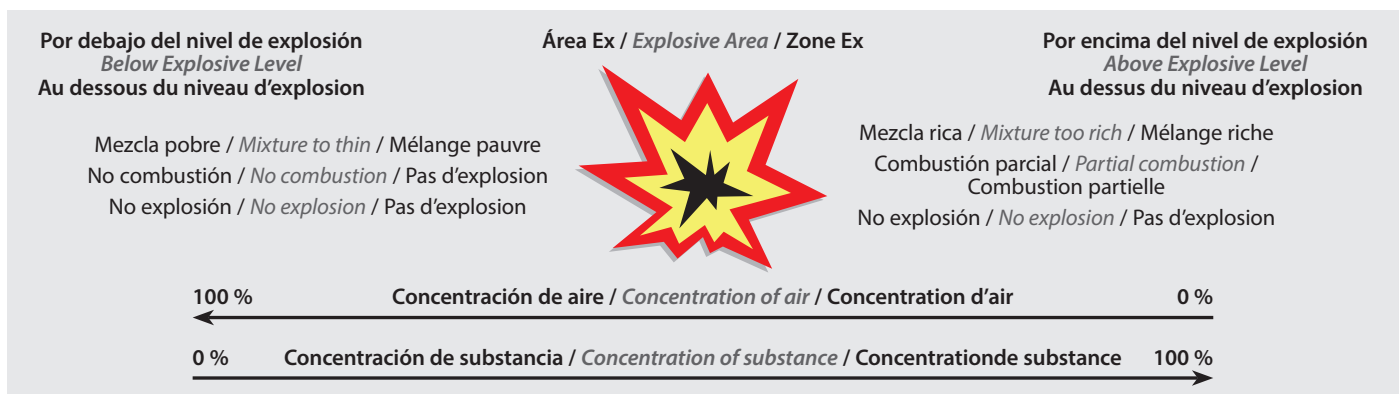

Las explosiones dependen de muchos parámetros.

Sólo para condiciones atmosféricas y sustancias puras se muestran valores y datos suficientemente comparativos. Una explosión puede ocurrir solamente donde una sustancia inflamable en forma de gases, vapores, humos y polvo se encuentra con suficiente oxígeno para alimentar la combustión y allí es donde se localiza la fuente de ignición.

#### Ejemplo:

Hidrógeno: entre 4,0 y 77,0 % en aire  
 Propano: entre 1,7 y 10,6 % en aire  
 Amoniaco: entre 15,4 y 33,6 % en aire  
 Metano: entre 4,4 y 16,5 % en aire

Explosions are dependent on many parameters.

Only for atmospherical conditions and pure substances sufficient comparative values and data are shown. An explosion can only occur where a flammable substance in the form of gases, vapours, smoke and dust exists along with sufficient oxygen to support -combustion and there is a source of ignition.

#### E.g.:

Hydrogen: 4,0 to 77,0 % in air  
 Propane: 1,7 to 10,6 % in air  
 Ammonia: 15,4 to 33,6 % in air  
 Methane: 4,4 to 16,5 % in air

Les explosions dépendent de beaucoup de paramètres.

Uniquement pour des conditions atmosphériques et des substances pures nous pouvons montrer des valeurs et des données suffisamment comparables. Une explosion peut se produire uniquement en présence de substances inflammables sous forme de gaz, de vapeurs, de fumées et de poussières, avec suffisamment d'oxygène pour alimenter la combustion, c'est, là que se trouve la source de l'ignition.

#### Exemple:

Hydrogène: entre 4,0 et 77,0 % dans l'air  
 Propane: entre 1,7 et 10,6 % dans l'air  
 Ammoniac: entre 15,4 et 33,6 % dans l'air  
 Méthane: entre 4,4 et 16,5 % dans l'air

## FUNDAMENTOS DE LA PROTECCIÓN FRENTE A LA EXPLOSIÓN DE POLVO

### FUNDAMENTALS OF DUST EXPLOSION PROTECTION

### BASES DE LA PROTECTION CONTRE L'EXPLOSION DE POUSSIÈRES

#### Principios fundamentales:

El fabricante de aparatos en uso en áreas definidas como potencialmente explosivas por causas del polvo debe indicar la máxima temperatura superficial de todos los aparatos en los que el polvo pueda penetrar (usualmente expresado en °C –la indicación de la clase de temperatura debería evitarse aquí). Esta temperatura es parte de la denominación Ex.

#### Ejemplos de denominación:

⊕ II 2 D T90°C IP64

(Si el tipo de protección frente a la ignición está basado en la carcasa, el ratio de protección de la carcasa debería también estar indicado por un código IP.)

o

⊕ II 2 D Ex iaD 21 T96°C

(Este aparato ya ha sido aprobado de acuerdo al nuevo estándar legal IEC “Seguridad Intrínseca del Polvo”) – “iaD”. Este estándar legal especifica que la denominación también contenga la zona correspondiente –en este caso 21).

#### Protección frente a la explosión de polvo - temperatura:

Los parámetros de combustión y explosión para el polvo dependen de su condición. Los parámetros que afectan al comportamiento de la combustión y la explosión incluyen el tamaño de las partículas, la forma de las partículas, el contenido de agua, la pureza y donde sea aplicable, el contenido de disolventes inflamables. La distribución del tamaño de las partículas y el valor medio (valor promedio de los tamaño de partícula) debería también ser conocido.

De acuerdo con la Directiva 1999/92/EG (ATEX 153, reemplazando a: ATEX 137), el operario del sistema/empleo está obligado a hacer una evaluación sobre el peligro y debe por tanto saber la mínima temperatura de quemado del polvo.

Existen simples cálculos para determinar las dos “temperaturas” y son:

- Temperatura límite 1 = 2/3 de la temperatura mínima de ignición.
- Temperatura límite 2 = temperatura mínima de ignición \* menos 75K.

Estas 2 temperaturas límite deben ser examinadas para confirmar cuál de ellas garantiza la mayor seguridad.

#### Ejemplo 1:

Temperatura mínima de ignición = +330 °C

Temperatura mínima de quemado = +300 °C

- Temperatura límite 1 =  $2/3 \times +330 \text{ °C} = +220 \text{ °C}$
- Temperatura límite 2 =  $+300 \text{ °C} - 75\text{K} = +225 \text{ °C}$

#### Fundamental principles:

The manufacturer of operating devices for areas rendered potentially explosive through dust must indicate the maximum surface temperature of all devices that dust can penetrate (usually expressed in °C –indication of the temperature class should be avoided here). This temperature is part of the dust Ex-designation.

#### Designation examples:

⊕ II 2 D T90°C IP64

(If the ignition protection type is based on the housing, the housing protection rating should also be stated as an IP Cede.)

or

⊕ II 2 D Ex iaD 21 T96°C

(This device has already been approved according to the new IEC de-jure standard “Intrinsic Dust Safety”) – “iaD”. This de jure standard specifies that the designation also contains the corresponding zone –in this case 21.)

#### Dust explosion protection - temperature:

Combustion and explosion parameters for dusts depend on their condition. Parameters that affect combustion and explosion behaviour include particle size, particle shape, water content, purity and where applicable the content of the flammable solvents. The particle size distribution and the mean value (value for average particle size) should also be known.

In accordance with 1999/92/G Directive (ATEX 153, replacing: ATEX 137), the system operator/employer is obliged to make a hazard assessment and must therefore be aware of the minimum glow temperature of the dust.

There are simple calculations to determine the two “temperatures” and they are carried out thus:

- Limit temperature 1 = 2/3 of minimum ignition temperature
- Limit temperature 2 = minimum ignition temperature \* minus 75°K

These two limit temperatures must now be examined to confirm which guarantees the greater safety.

#### Example 1:

Minimum ignition temperature = +330°C

Minimum glow temperature = +300°C

- Limit temperature 1 =  $2/3 \times +330 \text{ °C} = +220 \text{ °C}$
- Limit temperature 2 =  $+300 \text{ °C} - 75\text{K} = +225 \text{ °C}$

Greater safety:

Limit temperature (1) = +220°C

Here a device with a max. surface temperature in the event of failure  $\leq +220 \text{ °C}$  must be used.

#### Principes fondamentaux:

Le fabricant de matériel, destiné aux aires définies comme potentiellement explosives à cause de la poussière, doit indiquer la température maximum superficielle sur tous les appareils, à laquelle la poussière peut entrer (normalement exprimée en °C –l’indication de la classe de température devrait être évitée). Cette température fait partie de la désignation Ex.

#### Exemples de désignations:

⊕ II 2 D T90°C IP64

(Si le type de protection contre l’ignition est sur la carcasse, le ratio de protection de la carcasse devrait aussi être indiqué par un code IP.)

ou

⊕ II 2 D Ex iaD 21 T96°C

(Cet appareil a été déjà certifié suivant la nouvelle norme légale IEC “Sécurité intrinsèque de la poussière”) – “iaD”. Cette norme légale spécifie que la dénomination inclut aussi la zone correspondante, dans ce cas 21.)

#### Protection contre l’explosion de poussière - température:

Les paramètres de combustion et d’explosion de la poussière dépendent de sa forme. Les paramètres qui conditionnent le comportement de la combustion et de l’explosion, incluent la taille, la forme des particules, le contenu de l’eau, la pureté et son lieu d’application, le contenu des dissolvants inflammables. La répartition de la dimension des particules et la valeur moyenne (valeur moyenne de la taille des particules) devrait être aussi connue.

En accord avec la directive 1999/92/EG (ATEX 153, remplaçant: ATEX 137), l’opérateur du système/employé est obligé de faire une évaluation du risque et doit connaître au minimum la température minimale de combustion de la poussière.

Il existe de simples calculs pour déterminer les deux “températures” et ce sont:

- Température limite 1 = 2/3 de la température minimale d’ignition
- Température limite 2 = température minimale d’ignition \* moins 75K

Ces deux températures minimales doivent être connues pour confirmer laquelle fournit la plus grande sécurité

#### Exemple 1:

Température minimum d’ignition = +330°C

Température minimum de combustion = +300°C:

- Température limite 1 =  $2/3 \times +330 \text{ °C} = +220 \text{ °C}$
- Température limite 2 =  $+300 \text{ °C} - 75\text{K} = +225 \text{ °C}$

Plus grande sécurité:

Température limite (1) = +220°C

Mayor seguridad:

Temperatura límite (1) = +220 °C

Aquí debe usarse un aparato con una temperatura superficial máxima en caso de fallo  $\leq +220$  °C. Según lo indicado, la denominación del aparato incluye el valor correspondiente.

#### Ejemplo 2:

Temperatura mínima de ignición = +186 °C  
 Temperatura mínima de quemado = +180 °C

- a) Temperatura límite 1 =  
 $2/3 \times +186$  °C = +124 °C  
 b) Temperatura límite 2 =  
 $+180$  °C - 75K = +105 °C

Mayor seguridad:

Temperatura límite (2) = +105 °C

Aquí debe usarse un aparato con una temperatura superficial máxima en caso de fallo  $\leq +105$  °C.

- \* El valor para la temperatura de quemado se aplica con capas de polvo de espesores de 5 mm. La temperatura de seguridad debe incrementarse para mayores espesores de capa.

#### Caso especial - Aparatos de Categoría 3

A diferencia de los aparatos de Categoría 1 y 2, para los aparatos de Categoría 3 (de uso solamente en las Zonas 2 y 22 respectivamente) no deben tenerse en cuenta los peligros potenciales en caso de fallo (cortocircuitos, conexiones rotas, etc.). El aparato se evalúa solamente respecto a los peligros durante un funcionamiento normal. Es relativamente poco probable que el aparato falle al mismo tiempo que se presenta una breve atmósfera explosiva. Por lo tanto no se requiere ningún Certificado de Test de Aprobación del Tipo EC para los aparatos de Categoría 3. El fabricante puede confirmar que el aparato en uso cumple con el pertinente estándar. Sin embargo, los aparatos EGA Master de Categoría 3 están todavía siendo probados por un centro de certificación y EGA Master está por ello concediendo declaraciones de conformidad. (Naturalmente, los aparatos de Categoría 2 también ofrecen una significativa seguridad en las Zonas 2 y 22 respectivamente).

As stated, the device designation includes a corresponding value.

#### Example 2:

Minimum ignition temperature = +186 °C  
 Minimum glow temperature = +180 °C:

- a) Limit temperature 1 =  
 $2/3 \times +186$  °C = +124 °C  
 b) Limit temperature 2 =  
 $+180$  °C - 75°K = +105 °C

Greater safety:

Limit temperature (2) = +105 °C

Here a device with a max. surface temperature in the event of failure  $\leq +105$  °C must be used.

- \* The value for the glow temperature applies with a dust layer thickness of 5mm. The temperature safety distance must be increased for larger layer thicknesses.

#### Special case - Category 3 devices

In contrast to Category 1 and 2 devices, potential hazards in the event of failure (e.g. short circuiting, connection break etc.) do not have to be considered for Category 3 devices (for use only in Zones 2 respectively 22). The device is evaluated only in respect of hazards during normal operation, it is relatively unlikely that the device should fail at the same time as a short-term explosive atmosphere is present. No EC Type Approval Test Certificate is therefore required for Category 3 operating devices. The manufacturer may confirm that the operating device complies with the relevant standard. Nonetheless, EGA Master Category 3 devices are still tested by a certified centre and. EGA Master is then awarded a declaration of conformity. (Of course, Category 2 operating devices also offer significantly greater safety in Zones 2 respectively 22.)

Dust explosions – albeit of a predominantly minor nature – occur relatively frequently.

A leaflet issued by the Government Safety Organisation of the Federal Republic of Germany states:

"According to documentation published by property insurers, it can be assumed that an average of one dust explosion per day occurs in the Federal Republic of Germany; around one in four of these explosions are caused by foodstuff or animal feed dusts."

Ici, nous devons utiliser un appareil d'une température maximale superficielle en cas de problème  $\leq +220$  °C. Suivant l'indication, la dénomination de l'appareil inclut la valeur correspondante.

#### Exemple 2:

Température minimale d'ignition = +186 °C

Température minimum de combustion = +180 °C:

- a) Température limite 1 =  
 $2/3 \times +186$  °C = +124 °C  
 b) Température limite 2 =  
 $+180$  °C - 75K = +105 °C

Plus grande sécurité:

Température limite (2) = +105 °C

Dans ce cas nous devons utiliser un appareil avec une température superficielle maximum en cas de problème de  $\leq +105$  °C.

- \* La valeur pour la température de combustion s'applique sur les couches de poussière les plus épaisses de 5 mm. La température de sécurité doit être augmentée pour de plus grandes épaisseurs de couche.

#### Cas particulier - Appareils de Catégorie 3

A la différence des appareils de catégories 1 et 2, pour les appareils de catégorie 3 (d'utilisation uniquement en zones 2 et 22 respectivement) nous ne prenons pas en compte les dangers potentiels dus aux pannes (courtcircuits, connexions défaillantes, etc.). L'appareil est uniquement évalué pour les dangers en fonctionnement normal. Il est relativement peu probable que l'appareil aie un problème en même temps que la présence brève d'une atmosphère explosive. Le Certificat de Test de contrôle du type EC n'est pas obligatoire pour les appareils de catégorie 3. Le fabricant peut confirmer que l'appareil utilisé remplit les conditions de la norme. Mais, les appareils EGA Master de Catégorie 3 sont testés par un centre de certification et c'est pour cela qu'EGA Master délivre une déclaration de conformité. (Naturellement, les appareils de catégorie 2 offrent aussi une sécurité significative dans les Zones 2 et 22 respectivement).

#### ■ EXPLOSIONES DE POLVO POR TIPO DE POLVO DUST EXPLOSIONS BY DUST TYPE EXPLOSIONS DE POUDRE PAR TYPE DE POUDRE

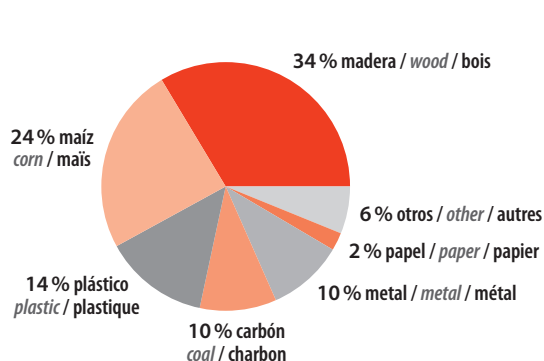

#### ■ FUENTES DE IGNICIÓN DE APARATOS ELÉCTRICOS IGNITION SOURCES BY ELECTRICAL OPERATING DEVICE TYPE SOURCES D'IGNITION D'APPAREILS ÉLECTRIQUES

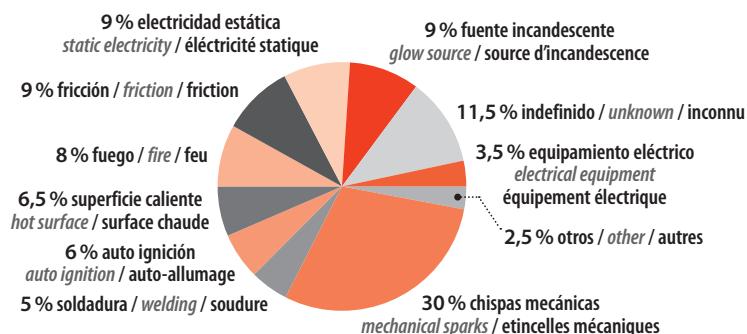

Las explosiones por polvo –aunque su existencia sea de naturaleza menor– ocurren relativamente con mucha frecuencia.

Un folleto informativo de la Organización Gubernamental de la Salud de la República Federal de Alemania afirma:

“De acuerdo a la documentación publicada por las aseguradoras, se establece que ocurre por media una explosión por polvo al día en la República Federal de Alemania, de las cuales una cuarta parte es causada por polvos de alimentación.”

Las explosiones por polvo son un problema global. En EE.UU., entre 1980 y 1990, por ejemplo, se registraron alrededor de 200 explosiones por polvo serias con polvos de alimentación, siendo causa de 54 muertes, 256 heridos y un daños a la propiedad de más de 165 millones de dólares.

Las fuentes de ignición de aparatos eléctricos representan solamente una pequeña proporción de las causas de ignición por polvo existentes –debido principalmente a las medidas de seguridad establecidas para la construcción de plantas eléctricas en zonas potencialmente explosivas.

La introducción de la regulación en plantas eléctricas en áreas potencialmente explosivas –ElexV" [1.4]– en 1980 especificó un tipo de certificado para los instrumentos eléctricos usados en la Zona 10 (desde 01.07.2003 en las Zonas 20 y 21).

Los instrumentos “protegidos contra explosiones por polvo”, cuya temperatura superficial permanece por debajo del límite aceptable para una capa de polvo estandarizada de 5 mm, pueden, aun cuando exista un certificado oficial, convertirse en fuente de peligro si, contrariamente a las condiciones, se cubren completamente por una capa espesa de polvo.

*Dust explosions are a world-wide problem. Between 1980 and 1990 in the USA, for example, some 200 serious foodstuff or animal feed related dust explosions were recorded, causing 54 deaths, 256 injuries and property damage amounting to 165 million US dollars.*

*Electrical operating devices represent only a small proportion of the ignition sources found to cause dust explosions –not least due to the safety stipulations in the regulations for erecting electrical plants in potentially explosive areas.*

*The introduction of the (Regulation on electrical plants in potentially explosive areas) –ElexV" [1.4]– in 1980 specified a type examination certificate for electrical operating devices used in Zone 10 (from 01.07.2003 in Zones 20 and 21).*

*“Dust explosion-protected” operating devices, the surface temperatures of which lies below the acceptable limit for standardised dust thickness of 5mm, can, despite the existence of an official test certificate, become a danger source if, contrary to the conditions, they become covered or completely encased with a thick layer of dust.*

Les explosions par la poussière –malgré que leurs existences à l'état naturel ne sont pas fréquentes– elles se produisent relativement souvent.

Un dossier d'information de l'Organisation Gouvernementale de la Santé de la République fédérale allemande affirme que:

“Conformément à la documentation publiée para les compagnies d'Assurance, il est établi qu'il se produit chaque jour, en RFA, une explosion par la poussière, dont d'entre elles sont provoquées par des poussières alimentaires.”

Les explosions par la poussière sont un problème global. En EE.UU, entre 1980 et 1990, par exemple, furent dénombrées plus de 200 explosions sérieuses par la poussière alimentaire, provoquant 54 morts, 256 blessés et des destructions matérielles évaluées à 165 millions de dollars.

Les sources d'ignition d'appareils électriques représentent uniquement une petite proportion des causes d'ignition par les poussières existantes –Cela du principalement aux mesures de sécurité établies pour la construction d'usines électriques en zones potentiellement explosives.

L'introduction de la régulation dans les usines électriques dans des aires potentiellement explosives –ElexV" [1.4]– en 1980 précisa un type de certificat pour les appareils électriques utilisés en zone 10 (depuis 01.07.2003 dans les zones 20 et 21).

Les appareils “protégés contre les explosions par la poussière”, dont la température superficielle reste au-dessous de la limite acceptable pour une couche de poussière d'une épaisseur standardisée de 5mm, peuvent, quand il existe un certificat officiel, devenir une source de danger si, contrairement aux conditions ils sont totalement couvert d'une épaisse couche de poussière.

## TIPOS DE PROTECCIÓN CONTRA IGNICIÓN

### TYPES OF IGNITION PROTECTION

### TYPES DE PROTECTIONS CONTRE L'IGNITION

#### Tipo de ignición “n”

La protección contra ignición n se puede aplicar únicamente para aparatos de la categoría 3, empleados en áreas clasificadas como potencialmente explosivas por gases. Como aquí no se considera la operación normal y no se contemplan fallos de equipo, se dan pocas diferencias en la designación del tipo de protección contra ignición:

- nA Equipo eléctrico antichispa (máquinas rotativas, fusibles, lámparas, indicadores y equipamiento de baja energía).
- nC Equipos con generación de chispa o altas temperaturas superficiales en condiciones operativas.
- nR Carcasa a prueba de vapores.
- nL Equipamientos y circuitos de baja energía.
- nP Carcasa contra sobrepresiones.

#### Ignition protection type “n”

*Ignition protection type n is applicable for Category 3 operating devices used in areas rendered potentially explosive by gases. Because only normal operation and no equipment failures are considered here, small differences occur in the designation for ignition protection type:*

- nA Non-sparking electrical equipment (revolving machines, fuses, lamps, gauges and equipment with low energy).
- nC Sparking equipment or equipment with hot surface under operating conditions (dosed indexing mechanism and non-ignitable components, air-tight equipment, leak-proof sealed equipment).
- nR Vapour-proof casing.
- nL Equipment and circuit with limited energy.
- nP Simplified overpressure casing.

#### Type d'ignition “n”

La protección contra la ignición no puede ser aplicada únicamente para los aparatos de categoría 3, utilizados en áreas clasificadas como potencialmente explosivas por los gases. Como aquí, la operación no es considerada normal, y no tenemos en cuenta los fallos de equipo, hay pocas diferencias en la designación del tipo de protección contra la ignición:

- nA Equipamiento eléctrico anti-déflagrante (máquinas rotativas, fusibles, lámparas, indicadores y equipamiento de baja tensión)
- nC Equipamientos generadores de étincelas o de altas temperaturas superficiales en condiciones operativas.
- nR Carcasa a la prueba de los vapores.
- nL Equipamientos y circuitos de baja tensión.
- nP Carcasa contra las sobrepresiones.

Forma de la protección contra ignición Form of ignition protection Forme de la protection contre l'ignition	Descripción esquemática Schematic description Description schématique	Principio básico Basic principle Principe de base	Standard
General		Precauciones generales de diseño y comprobación del material eléctrico diseñado para zonas Ex. <i>General provisions for the design and testing of electrical equipment which is designed for the ex range.</i> Dispositions générales pour le dessin et le test électrique équipement désigné par le Zone ex.	EN 50014
Seguridad incrementada Increased safety Sécurité augmentée	e 	Sólo se aplica a equipos o componentes que normalmente no generan arcos o chispas, no consiguen altas temperaturas y los voltajes principales no superan 1 kV. <i>Only applies to equipment or the components of which usually do not generate sparks or arcs, do not adopt dangerous temperatures and the mains voltage of which does not exceed 1 kV.</i> S'appliquent uniquement à des appareils ou des composants qui normalement ne génèrent pas d'arcs ni d'étincelles, n'arrivent pas à de hautes températures et à des voltage principaux inférieurs 1kV.	EN 50 019 IEC 60 079-7 FM 3600 UL 2279
Carcasa a prueba de presión Pressure-proof casing Carcasse à l'épreuve de la pression	d 	En caso de ignición dentro de la carcasa, la explosión es contenida en el interior. <i>In the case of an ignition inside the casing, the explosion is contained within the casing.</i> En cas d'ignition à l'intérieur de la carcasse, l'explosion est contenue.	EN 50 018 IEC 60 079-1 FM 3620 UL 2279
Presurización Pressurisation Préssurisation	p 	La fuente de ignición esta sellada por un gas protector de ignición bajo presión. La atmósfera medioambiental no puede introducirse en el gas protector de ignición. <i>Ignition source is sealed in by an ignition protection gas which a under overpressure (mind, 0,5 mbar) Ignition protection gas the environment atmosphere cannot enter.</i> La source d'ignition est isolée par un gaz protecteur sous pression. L'atmosphère du milieu-ambiant ne peut entrer en contact avec le gaz protecteur.	EN 50016 IEC 60 079-2 FM 3620 NFPA 496
Seguridad intrínseca Intrinsic safety Sécurité intrinsèque	i 	Se evitan arcos, chispas y altas temperaturas a través de la restricción en la energía del circuito. <i>By restriction of the energy in the circuit the development of inadmissibly high temperatures, ignition sparks and arcs are avoided.</i> On évite les arcs, les étincelles et les hautes températures au travers de la restriction de l'énergie du circuit.	EN 50 020 IEC 60 079-11 FM 3610 UL 2279
Inmersión en aceite Oil immersion Immersion dans l'huile	o 	El equipo o parte de él es sumergido en aceite, el cual los separa del ambiente. <i>Equipment or parts of the equipment are put into an oil casing - by which they are separated from the ex atmosphere.</i> Tout ou partie de l'équipement est immergé dans de l'huile, ce qui l'isole de l'air ambiant.	EN 50 015 IEC 60 079-6 FM 3600 UL 2279
Relleno de polvo Powder filling Rempli de poussière	q 	La fuente de ignición esta encapsulada en arena de grano fino, lo que evita que el ambiente EX no pueda ser prendido por un arco. <i>Ignition source encased by fine-grained sand -the enviroment ex atmosphere cannot be ignited by an arc.</i> La source d'ignition est capsulée dans du sable très fin, ce qui évite que l'air ambiant EX ne puisse être atteint par un arc.	EN 50 017 IEC 60 079-18 FM 3600
Encapsulación Encapsulation Capsulage	m 	Encapsulando la fuente de ignición en un material lechoso, no puede prender la atmósfera Ex. <i>By encapsulating the ignition source into a grouting material, it cannot ignite an ex atmosphere.</i> La source d'ignition est capsulée dans un matériau laitieux, elle ne peut être atteinte par l'atmosphère Ex.	EN 50 028 IEC 60 079-18 FM 3600 UL 2279
No incendiaria Non-incendive Pas d'allumage	n Zona 2. En esta forma de protección contra la ignición se combinan varios métodos de protección contra la ignición. <i>Zone 2. In this form of ignition protection multiple methods of ignition are combined.</i> Zona 2. Dans cet etui de protection contre l'ignition multiples methods d'ignition protection est combinée.	Aplicación ligeramente simplificada de otras formas de protección contra la ignición de la zona 2 - "n" simboliza "no incendiaria". <i>Slightly simplified application of other zone-2 forms of ignition protection - "n" stands for "non-incendive".</i> Application très simple de une autre zone-2 forme of ignition protection - "n" stands for "non-incendive".	EN 50 021 IEC 60 079-15

## GRADO DE PROTECCIÓN IP IP DEGREE PROTECTION IP GRADE DE PROTECTION

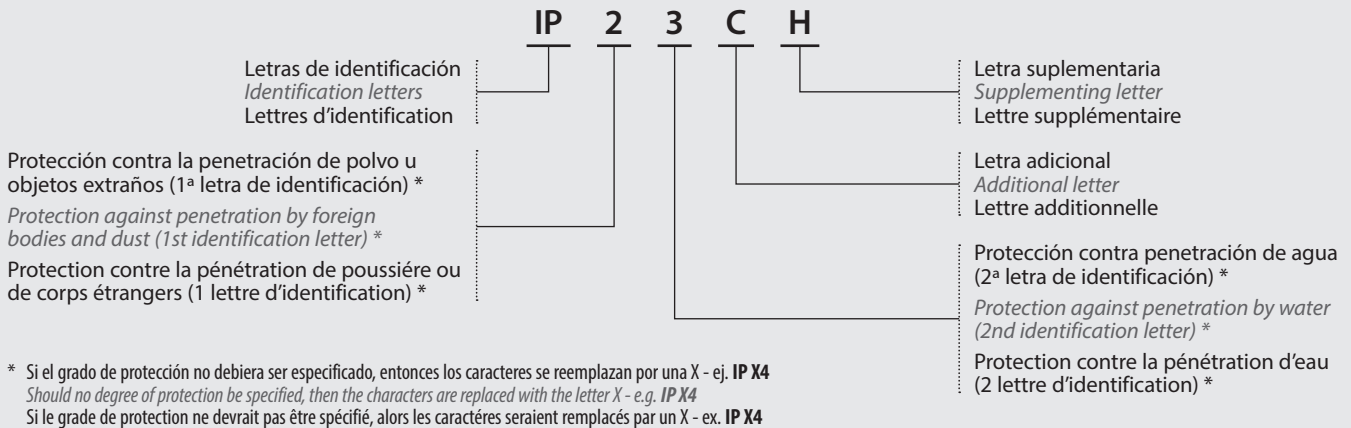

1ª letra ident 1st ident letter 1 lettre ident	Grado de protección Degree of protection Grade de protection	Símbolo Symbol Symbole
0	Sin protección. / No protection. / Sans protection.	
1	Protección contra penetración de partículas extrañas de gran tamaño, 0>50 mm. Sin protección contra acceso intencionado. / Protection against penetration by large foreign bodies, 0>50 mm. No protection against intentional access. / Protection de pénétration de particules étrangères de grande taille, 0>50 mm. Sans protection contre une entrée volontaire.	
2	Protección contra penetración de partículas extrañas de pequeño tamaño 0>12,5 mm, exclusión de dedos u objetos similares. / Protection against small foreign bodies, 0>12,5 mm, exclusion of fingers or similar objects. / Protection contre la pénétration de particules étrangères de petite taille, 0>12,5 mm, exclusion faite de doigts ou objets similaires.	
3	Protección contra penetración de partículas extrañas de pequeño tamaño, 0>2,5 mm, exclusión de herramientas, cables u objetos similares. / Protection against small foreign bodies, 0>2,5mm, exclusion of tools, wires or similar objects. / Protection contre la pénétration de particules étrangères de petite taille, 0>2,5 mm, hors outils, cables ou objets similaires.	
4	Protección contra partículas granulares, 0>1mm, exclusión de herramientas, cables u objetos similares. / Protection contre des particules granuleuses, 0>1mm, hors outils, cables ou objets similaires.	
5	Protección contra deposiciones de polvo (protección contra polvo), exclusión completa de acceso. / Protection against dust deposits (dustprotected), complete exclusion of access. / Protection contre des dépôts de poussières (protection contre poussière), totalement hermétique.	
6	Protección total contra deposiciones de polvo (protección contra polvo), exclusión completa de acceso. / Totally protection against dust deposits (dust protected), complete exclusion of access. / Protection totale contre dépôts de poussière (protection contre poussière), complète exclusion d'accès.	

1ª letra ident 1st ident letter 1 lettre ident	Grado de protección Degree of protection Grade de protection	Símbolo Symbol Symbole
0	Sin protección. / No protection. / Sans protection.	
1	Protección contra caída de agua cayendo de forma vertical. / Protection against drops of water falling vertically (water drop). / Protection contre la tombée d'eau de forme vertical.	
2	Protección contra caída de agua en ángulo, inclinado a 15° de la posición normal de operación. / Protection against water falling at an angle (water drop), inclined at 15° to the normal operating position. / Protection contre des chutes d'eau, inclinées a 15° par rapport à la position normale.	
3	Protección contra spray de agua, hasta 60° de la vertical. / Protection against water spray, up to 60° from the vertical. / Protection contre des brumisations, jusqu'à 60° de la verticale.	
4	Protección contra salpicaduras de agua desde cualquier dirección. / Protection against water splashes from any direction. / Protection de projections d'eau de toutes directions.	
5	Protección contra chorro de agua desde cualquier dirección. / Protection against water jet from any direction. / Protection de jets d'eau provenant de toutes directions.	
6	Protección contra mar ajetreado o fuerte chorro de agua (Protección contra inundaciones). / Protection against heavy sea or strong water jet (Flooding protection). / Protection contre une tempête ou un fort jet d'eau (Protection contre les inondations)	
7	Protección contra inmersión en agua a cierta presión durante cierto tiempo. / Protection against submersion in water at a certain pressure and for a certain period. / Protection contre immersion en l'eau à certaine pression et pendant certain temps.	
8	Protección contra inmersión en agua continua. / Protection against continuous submersion in water. / Protection totale contre une immersion dans l'eau.	

Letra adicional Additional letter Lettre additionnelle	Significado (facultativo) Significante (facultative) Significatif (facultatatif)
A	Parte posterior de la mano / Back of the hand / Partie postérieure de la main
B	Dedo / Finger / Doigt
C	Herramientas / Tools / Outils
D	Cable / Wire / Cable

Letra suplementaria Supplementing letter Lettre supplémentaire	Significado (facultativo) Significante (facultative) Significatif (facultatatif)
H	Aparato de alto voltaje / High voltage apparatus / Appareil de haut voltage
M	Máquina en marcha / Machine running / Machine en marche
S	Máquina parada / Machine not running / Machine arrêtée
W	Condiciones meteorológicas / Weather conditions / Conditions météorologiques

## DIVISION POR ZONAS DIVISION INTO ZONES DIVISION PAR ZONES

### La seguridad es nuestra primera prioridad

En todos los lugares donde se produzcan, procesen, transporten o almacenen sustancias inflamables, la seguridad es extremadamente importante, especialmente en las industrias químicas y petroquímicas, en la producción de petróleo y gas natural y en la minería.

Con el objetivo de proveer el mayor nivel de seguridad, la mayoría de las legislaciones estatales han desarrollado leyes y regulaciones al respecto. En un entorno cada vez más globalizado, se han dado pasos importantes en la estandarización y puesta en común de las guías a seguir en la protección contra explosiones. Es la Unión Europea la que abanderó este camino. La directiva 94/9/EG supuso el comienzo hacia la unificación. Desde el 1 de julio de 2003 todos los aparatos deben estar aprobados según esta directiva.

#### Significado de la clasificación por zona:

- **Zona 0/20:** Peligro presente en todo momento, por largos periodos de tiempo o frecuentemente.
- **Zona 1/21:** Peligro presente ocasionalmente.
- **Zona 2/22:** Peligro presente de forma poco frecuente o por corto espacio de tiempo.

### Safety is our first priority

*At all places where inflammable substances are produced, processed, transported or stored, safety is extremely important, especially in the chemical and petrochemical industry, in oil and natural gas production and in mining.*

*In order to provide the highest level of safety possible, most state's legislations have developed corresponding conditions in the form of laws, regulations and standards. In the course of globalisation, enormous progress could be made in uniform guidelines for explosion protection. It is the European Union that is leading the way. The 94/9/EG guideline lays the foundation for a complete unification. As of 01 July 2003, all new devices must be approved in accordance with this guideline.*

#### Meaning of the zone classification:

- **Zone 0/20:** Danger is always present, for a long time or frequently.
- **Zone 1/21:** Danger is occasionally present.
- **Zone 2/22:** Danger is seldom present or present for a short time.

### La sécurité est notre première priorité

Dans tous les lieux où on produit, transforme, transporte ou emmagasine des substances inflammables, la sécurité est extrêmement importante, spécialement dans l'industrie chimique et pétrochimique, dans la production de pétrole et de gaz et dans les mines.

Ayant pour objectif d'atteindre le plus haut niveau de sécurité, la plus grande partie des législations étatiques, a développé des lois et des réglementations à ce sujet. Dans un environnement toujours plus globalisé, de grands pas ont été faits pour la normalisation et la mise en commun des chemins à suivre pour la protection contre les explosions. C'est l'Union Européenne qui a initié ce chemin. La directive 94/9/EG fut mise en oeuvre lors de l'unification. Depuis le 1<sup>er</sup> juillet 2003 tous les appareils doivent être approuvés suivant cette directive.

#### Signification de la classification par zone:

- **Zone 0/20:** Danger présent à tout moment, par longues ou fréquentes périodes.
- **Zone 1/21:** Danger présent occasionnellement.
- **Zone 2/22:** Danger présent peu fréquent ou sur de très courtes durées.

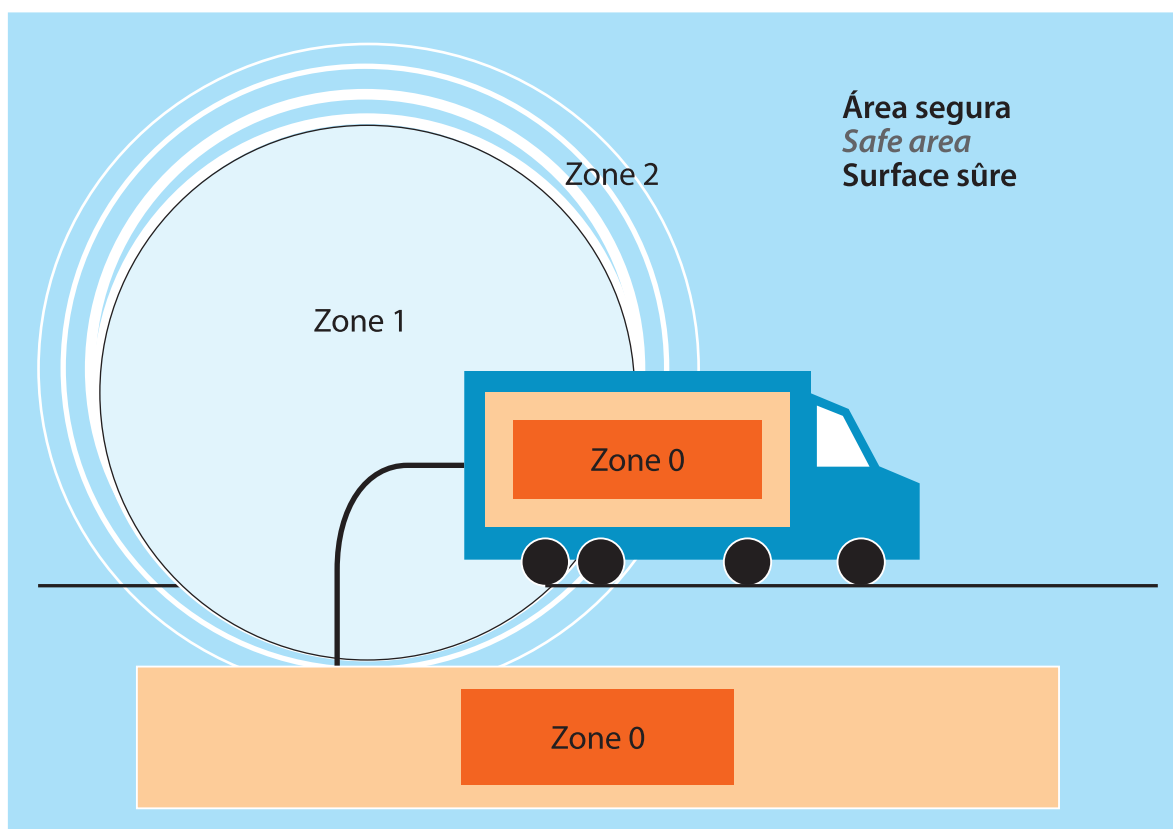

■ CÁMARA / CAMERA / CAMÉRA / KAMERA / CAMERA / CÂMARA / KAMERA

**CÁMARA DIGITAL INTRÍNECAMENTE SEGURA**  
**INTRINSICALLY-SAFE DIGITAL CAMERA**  
**CAMÉRA DIGITALE INTRINSÈQUEMENT SÛRE**  
**EX-GESCHÜTZTE DIGITALKAMERA**  
**CAMERA DIGITALE INTRINSECAMENTE SICURA**  
**CÂMARA DIGITAL INTRINSECAMENTE SEGURA**  
**ВЗРЫВОБЕЗОПАСНАЯ ЦИФРОВАЯ КАМЕРА**

■ MASTEREX 79789



La cámara digital intrínsecamente segura MasterEx 79789 es la herramienta de visualización perfecta para áreas con peligro de explosión. Con certificación ATEX e IECEx, la MasterEx 79789 puede usarse en todos los sectores, como por ejemplo en plantas químicas y farmacéuticas, plataformas de producción de petróleo y gas, refinerías, minería y servicios de emergencia, entre otros.

Fabricada en plástico antiestático reforzado, la MasterEx 79789 está clasificada como IP65, con lo cual puede emplearse en los ambientes más duros. Gracias a su carcasa fina y alargada, su peso no supera los 200g, lo que la convierte en la herramienta perfecta para el transporte de bolsillo.

Equipada con un flash 4 LEDs de alto brillo, tecnología antivibraciones y una resolución de 3,1 megapixels, la MasterEx 79789 ofrece imágenes de alta calidad en ambientes con alto peligro de explosión, y de forma segura.

La transferencia de datos a cualquier ordenador en un área segura es simple y fácil de llevar a cabo vía puerto USB empleando el PTP (protocolo de transferencia de fotos), que se inicia automáticamente.

La hora y la fecha se imprimen automáticamente en todas las fotografías para crear una historia cronológica, uniéndose automáticamente la función Anotación Verbal de Audio al nombre del archivo.

*The MasterEx 79789 intrinsically safe digital camera is the perfect visualisation tool for use in hazardous areas. ATEX and IECEx certified, MasterEx 79789 can be used in all sectors of industry including Chemical & Pharmaceutical plants, Oil & Gas production platforms, Refineries, Mining and Emergency Services to name but a few.*

*Made of rugged injection moulded anti-static plastic, MasterEx 79789 is IP65 rated and is suitable for use in the most arduous environments. Due to its long slim lightweight enclosure weighing less than 200 g, MasterEx 79789 lends itself to single handed operation, making it convenient to carry in your pocket.*

*Equipped with its super bright 4 LED flash, anti-shake technology and 3.1 mega pixel resolution, MasterEx 79789 provides high quality images in all Hazardous Area environments.*

*Data transfer to any computer in the safe area is simple and easy to undertake via a USB port utilising Picture Transfer Protocol (PTP) which is initiated automatically.*

*All images are date and time stamped to create a chronological history and are coupled to the unique function of Voice Annotation Audio records, which are systematically matched to the image file name.*

La cámara digital intrínsecamente segura MasterEx 79789 es el instrumento de visualización perfecto para las zonas con peligro de explosión. Gracias a los certificados ATEX e IECEx, la MasterEx 79789 puede emplearse en todos los sectores, como por ejemplo: las industrias químicas y farmacéuticas, plataformas de producción de petróleo y gas, refinerías, minería y servicios de urgencias, entre otros.

Fabricada en plástico antiestático reforzado, la MasterEx 79789 está clasificada como IP65, por lo que puede utilizarse en los entornos más críticos. Gracias a su carcasa fina y alargada, su peso no supera los 200g, lo que la convierte en el instrumento perfecto y fácil de guardar en el bolsillo.

Equipada con un flash de 4 diodos de alta brillantez, tecnología anti-vibraciones y una resolución de 3,1 megapixels, la MasterEx 79789 ofrece de forma segura imágenes de alta calidad en entornos con alto peligro de explosión.

El intercambio de datos a cualquier ordenador en un área segura es simple y fácil de llevar a cabo vía puerto USB empleando el PTP (protocolo de transferencia de fotos) que se inicia automáticamente.

La hora y la fecha se imprimen automáticamente en todas las fotografías para crear una historia cronológica, todo ello añadiendo la función Anotación Verbal de Sonido al nombre del archivo.



■ CÁMARA / CAMERA / CAMÉRA / KAMERA / CAMERA / CÂMARA / KAMERA

Zonas / Zones

0, 1, 2 GAS / GAZ  
M1 MINERÍA / MINING / MINIÈRE

COD.

79789



\* G12

El código 79789 incluye una funda protectora de goma para proteger la cámara y evitar resbalones inesperados cuando se utiliza con guantes.

Code 79789 includes a protective rubber cover to protect the camera and avoid unexpected slipping while using gloves.

Le code 79789 inclut un étui protecteur en caoutchouc afin de protéger la caméra et d'éviter des chutes inopinées lorsqu'on utilise des gants.

■ MASTEREX 79789

ESPECIFICACIONES TÉCNICAS / TECHNICAL SPECIFICATION / DÉTAILS TECHNIQUES

Resolución / Resolution / Résolution	3,1 MegaPixel (2048 x 1536)
Memoria interna / Internal memory / Mémoire interne	1 Gb
Flash	4x LED de alto brillo / 4x LED of high brightness / 4 x LED de haute brillance
Transferencia de datos / Data transference / Transfert de données	USB 1.1
Clase de protección / Protection class / Classe de protection	IP65
Temperatura de trabajo / Working temperature / Température de travail	Grupo II: -20 °C - +60 °C Grupo I: 0° - +60 °C / Group II: -20 °C - +60 °C Group I: 0° - +60 °C / Groupe II: -20 °C - +60 °C Groupe I: 0° - +60 °C
Marcaje temporal de imágenes / Image date and time stamping / Marquage temporel d'images	●
Imagen / Image / Image	JPG
Almacenamiento de imágenes con fecha y hora / Image storage with time and date / Emmagasinement des images avec dates et heure	●
Funda protectora de goma / Protective rubber cover / Étui protecteur en caoutchouc	●
Anotación de voz / Voice annotation / Annotation de voix	WAV
Anti Shake	●
Función auto-apagado / Auto power-off / Fonction auto-éteint	3 mins
Lente / Lens / Lentille	Enfoque automático, 3, 39 mm / Automatic focus, 3,39 mm / Focalisation automatique, 3,39mm
Distancia focal / Focal distance / Distance focale	5 cm
Pilas / Batteries / Piles	2X AA
Designación ATEX / ATEX marking / Marquage ATEX	Ⓢ II 1 G Ex ia IIB T4/T3 Ga Ⓢ II 2 G Ex ia IIC T4 Gb -20 °C ≤ Ta ≤ +60 °C Ⓢ I M1 Ex ia I Ma 0 °C ≤ Ta ≤ +60 °C
Dimensiones / Dimensions / Dimensions	132 x 32 x 22 mm
Peso / Weight / Poids	200 gr
Material / Material / Matière	Plástico antiestático reforzado / Reinforced antistatic plastic / Plastique antistatique renforcé

■ COMUNICACIÓN / COMMUNICATION / COMMUNICATION / KOMMUNIKATION / COMUNICAZIONE / COMUNICAÇÃO / СВЯЗЬ



**RADIOTRASMISOR INTRÍNECAMENTE SEGURO**  
**INTRINSICALLY SAFE TWO-WAY-RADIO**  
**RADIO-TRANSMETTEUR INTRINSÈQUEMENT SÛR**  
**EXPLOSIONSGESCHÜTZTES HANDFUNKGERÄT**

■ **MASTEREX 79788**

**COMUNICACIÓN EN LAS ZONAS EX**

El Radiotransmisor MasterEX 79788 cumple con las últimas normas y puede usarse en áreas con evaluaciones de protección Ex II 2G Ex ia IIC T4 en las Zonas 1 y 2, de acuerdo con las directivas ATEX. Esta radio profesional opera en banda de frecuencia VHF 136-174 MHz. El poder de transmisión de la radio se ha limitado a 1 vatio por seguridad en el trabajo en las áreas potencialmente explosivas y la iniciación de llamadas a grandes distancias.

Además, el MasterEX 79788 cumple con IP68 y por consiguiente satisface las altas demandas industriales en robustez y fiabilidad, particularmente en áreas de riesgo Ex.

Los sistemas piloto de tonos CTCSS y DCS y los modos de señal con cinco-tonos garantizan que la

**RADIOTRASMISOR INTRINSECAMENTE SEGURO**  
**RÁDIO TRANSMISSOR INTRINSECAMENTE SEGURO**  
**ВЗРЫВОБЕЗОПАСНОЕ ДВУХКАНАЛЬНОЕ РАДИО**

comunicación es segura previniendo la interferencia de otra comunicación de radio.

El MasterEX 79788 está provisto con una variedad de mecanismos para proteger al trabajador solitario. El sensor de posición integrado habilita la supervisión de ángulos y activará una alarma automática en situaciones de emergencia (interruptor de hombre muerto). Las funciones para protección del trabajador solitario así como el botón de emergencia también permiten activar las alarmas manualmente por el trabajador en situaciones de emergencia.

Todos los parámetros para las funciones del MasterEX 79788 pueden cómodamente ajustarse en un PC usando el juego de software correspondiente y también pueden salvarse para programar diversas unidades. El trabajo es así minimizando y se asegura que todas las radios armonizan entre sí.

**COMMUNICATION IN EX-AREAS**

The Two-way-radio MasterEX 79788 meets the latest standards and can be used in areas with protection assessments Ex II 2G Ex ia IIC T4 in Zone 1 and 2, according to the ATEX directives.

This professional radio operates in frequency band VHF 136-174 MHz. The radio's transmission power has been limited to 1 watt for safe working in potentially explosive areas and initiating calls even over large distances.

In addition, the MasterEX 79788 complies with IP68 and therefore satisfies high industrial demands on ruggedness and reliability, particularly in ex-hazardous areas.

The CTCSS and DCS pilot tone systems and the five-tone signalling mode guarantee that communication

is secure thus preventing interference from other radio communication.

The MasterEX 79788 is equipped with a variety of mechanisms to protect lone workers. The integrated position sensor enables the monitoring of angles and will in emergency situations trigger an automatic alarm (dead-man's switch). The functions for protecting lone workers as well as the emergency button also allow manual alarms to be triggered by workers in emergency situations.

All parameters for the MasterEX 79788 functions may be comfortably set on a PC using the corresponding software kit and can also be saved for programming several units. Thus minimizing work and ensuring that all radios harmonize with each other.

**COMMUNICATION DANS LES ZONES EX**

Le Radio-transmetteur MasterEX 79788 répond aux normes les plus récentes et est utilisable, conformément aux directives ATEX, avec un niveau de protection Ex II 2G Ex ia IIC T4, dans les zones 1 et 2.

Cet appareil de radiocommunication professionnel fonctionne sur bande de fréquence VHF 136-174 MHz. La puissance d'émission de ce portatif radio est limitée à 1 watt, vous permettant ainsi de travailler en toute sécurité en zones explosibles et d'établir des connexions radio également sur de longues distances.

Le MasterEX 79788 répond en outre à l'indice de protection IP68 et satisfait ainsi aux exigences industrielles élevées en termes de robustesse et de fiabilité, particulièrement en zones explosibles.

Les systèmes de squelch à tonalités codées CTCSS et DCS et la signalisation 5 tons des modes de codage garantissent une communication sûre et empêchent que d'autres utilisateurs n'entendent vos échanges.

Le MasterEX 79788 est équipé de dispositif d'alarme pour travailleur isolé. Le capteur de position intégré permet de surveiller les mouvements et déclenche en cas d'urgence une alarme automatique (mode homme mort). Des alarmes volontaires peuvent également être déclenchées par des travailleurs en situation d'urgence via la fonction DATi (Dispositif d'Alarme pour Travailleur isolé) ou via la touche d'appel de secours.

Tous les paramètres des fonctions du MasterEX 79788 se règlent confortablement sur PC à l'aide du kit logiciel et peuvent être mémorisés pour la programmation d'autres appareils. Cela vous permet de gagner du temps et de vous assurer que tous les portatifs fonctionnent à l'unisson.

■ **ACCESORIOS / ACCESSORIES / ACCESSOIRES / ZUBEHÖR / ACCESSORI / ACCESSORIOS / ЗАПАСНЫЕ ЧАСТИ**

COD.	
79790	Cable programación / Programming cable / Câble de programmation
79793	Adaptador para USB / Adapter for USB/ Adaptateur pour USB



■ **REPUESTOS / SPARE PARTS / RECHANGES/ ERSATZTEILE/ ACCESSORI / ACCESSORIOS / ЗАПАСНЫЕ ЧАСТИ**

COD.	
79814	Batería / Battery / Batterie



\* **G12: GARANTÍA 12 MESES / 12 MONTHS OF WARRANTY / 12 MOIS DE GARANTIE / 12 MONATEN GARANTIE / 12 MAANDEN GARANTIE / 12 MESI DI GARANZIA / 12 МЕСЯЦЕВ ГАРАНТИЯ**

■ COMUNICACIÓN / COMMUNICATION / COMMUNICATION / KOMMUNIKATION / COMUNICAZIONE / COMUNICAÇÃO / СВЯЗЬ

Zonas / Zones

1, 2 GAS / GAZ

\* G12

COD.

79788



■ MASTEREX 79788

El MasterEx 79788 es un radiotransmisor para la comunicación inalámbrica en las zonas EX.

- LCD 255 canales

**Datos Ex:**

Designación ATEX:  
Ⓢ II 2 G Ex ia IIC T4

**Certificado del tipo de examinación:**

ZELM 06 ATEX 0318

**Equipamiento:**

- Unidad de radio MasterEx 79788
- Batería-Ex Ex-AM MasterEx 79788
- Pinza para cinto para el MasterEx 79788
- Manual de instrucciones

The MasterEx 79788 is a license and charge-free two-way radio for wireless communication in Ex-hazardous areas.

- LCD 255 channels

**Ex-data:**

ATEX marking:  
Ⓢ II 2 G Ex ia IIC T4

**Type examination certificate:**

ZELM 06 ATEX 0318

**Standard delivery:**

- Radio unit MasterEx 79788
- Ex-battery Ex-AM 79788
- Belt clip for MasterEx 79788
- Operating instructions

Le MasterEx 79788 est un radiotransmetteur pour la communication inalámbrica dans les zones EX.

- LCD 255 canaux

**Renseignements Ex:**

Marquage ATEX:  
Ⓢ II 2 G Ex ia IIC T4

**Certificat du type de test:**

ZELM 06 ATEX 0318

**Equipement:**

- Unité de radio MasterEx 79788
- Batterie-Ex Ex-AM MasterEX 79788
- Pince de ceinture pour le MasterEx 79788
- Manuel d'instructions

ESPECIFICACIONES TÉCNICAS / TECHNICAL SPECIFICATION / DÉTAILS TECHNIQUES

Rango de frecuencia / Frequency range / Eventail de fréquences	136 - 174MHz
Canales / Channels / Canaux	LCD 255 canales (no 16) / Non LCD 16 Channels, LCD 255 channels / LCD 255 canaux (no 16)
Anchura de canal / Channel spacing / Longueur de canal	12.5 kHz / 25 kHz
Método commutación / Communication method / Méthode de commutation	Simplex / semi duplex
Impedancia de antena / Antenna resistance / Impédance de l'antenne	50 Ω
Antena / Antenna / l'antenne	Whip / stubby
Micrófono / Microphone / Microphone	Micrófono de condensador interno / Internal condenser microphone / Microphone à condensateur interne
Batería / Battery / Batterie	1800mAh Recargable de litio / 1800mAh Rechargeable lithium / 1800mAh Rechargeable de lithium
Voltaje operativo / Operating voltage / Tension de fonctionnement	7.4V DC
Corriente (nominal) / Current drain (nominal) / Courant (nominal)	40mA
Protección IP / IP protection / Protection IP	IP68
Temp. ambiente / Ambient temp / Temp. ambiante	-20° to +55°C
Autonomía / Autonomy / Autonomie	14.5 horas / 14.5 hours / 14.5 heures
Designación ATEX / ATEX marking / Marquage ATEX	Ⓢ II 2 G Ex ia IIC T4
Dimensiones / Dimensions / Dimensions	59.5(W) x 130(H) x 37(D)
Peso / Weight / Poids	277g con batería y aéreo / 277g with battery and aerial / 277g À batterie et aérien
<b>TRANSMISOR / TRANSMITTER / TRANSMETTEUR</b>	
Potencia / Power / Puissance	1W
Modulación / Modulation / Modulation	8K0G3E/16K0G3E
Método oscilación / Oscillator method / Méthode oscillatoire	PLL
Frecuencia de estabilidad / Frequency stability / Stabilité de fréquence	2.5PPM
Máxima desviación / Maximum deviation / Écart maximal	±2.5 kHz(mínima)/ ±5 kHz(amplia) / ±2.5 kHz(Narrow)/ ±5 kHz(Wide) / ±2.5 kHz(minimum) / ±5 kHz(large)
Distorsión sonido / Sound distraton / Distorsion sonore	< 5% (1 kHz 60%)
<b>RECEPTOR / RECEIVER / RÉCEPTEUR</b>	
Tipo receptor / Receiver type / Type récepteur	Double Super Heterodyne
Sensibilidad / Sensitivity / Sensibilité	-0.25uV (12dB SINAD)
Frecuencia de estabilidad / Frequency stability / Stabilité de fréquence	2.5PPM

■ MEDICIÓN / MEASURING / MESURE / MESSEN / MISURE / MEDIÇÃO / ИЗМЕРЕНИЯ



**TESTER MAGNÉTICO INTRÍSECAMENTE SEGURO**  
*INTRINSICALLY SAFE MAGNET PROBE*  
**TESTEUR DE MAGNÉTISME INTRINSÈQUEMENT SÛR**  
*EX-SICHERES MAGNETTESTER*  
**TESTER MAGNETICO INTRINSECAMENTE SICURO**  
*TESTER MAGNÉTICO INTRINSECAMENTE SEGURO*  
**ВЗРЫВОБЕЗОПАСНЫЙ МАГНИТНЫЙ ПРОБНИК**

■ MASTEREX 79784

MasterEx 79784 es un medidor magnético tamaño lápiz, diseñado para detectar campos magnéticos en áreas peligrosas. En pocos segundos es capaz de detectar cualquier solenoide que esté eléctricamente activada.

No es necesario una conexión al circuito eléctrico o abrir una caja de terminales.

La alta sensibilidad del punto del tester de MasterEx 79784 provoca que sólo con acercarse a la bobina del solenoide, si ésta muestra una luz roja, indica que el campo magnético está activado. De la misma manera esta prueba se puede efectuar cerca sobre fluxómetros u otros equipamientos que trabajen magnéticamente, incluso cuando estén localizadas en áreas peligrosas.

El MasterEx 79784 viene integrado con un imán de seguridad para que no pueda ser perdido con facilidad. Usando este imán, la prueba se puede efectuar para conocer el estado de trabajo de la unidad y de las baterías.

Después de cualquier chequeo el MasterEx 79784 se apagará automáticamente si no es utilizado durante un tiempo. Esto asegura una larga vida de las baterías.

El clip incluido en un lado del aparato lo asegura por si hay pérdidas accidentales y permite al ingeniero llevarlo todo el tiempo con facilidad.

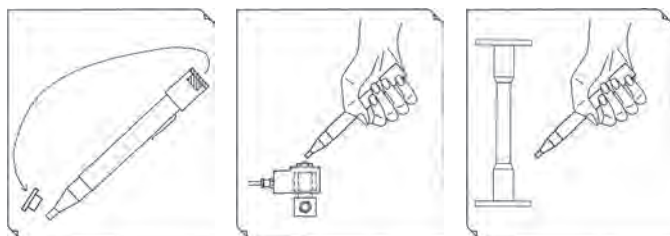

MasterEx 79784 is a pen-sized magnet probe, designed to detect magnetic fields in hazardous areas. Within seconds it is possible to detect whether or not a solenoid valve is electrically activated.

Connection to electronic circuitry or opening of terminal boxes is rendered unnecessary.

The highly sensitive probe point of the MasterEx 79784 only needs to be brought near the coil of a solenoid valve, if the probe shows a red light this indicates that the magnet is activated. In the same manner tests can be carried out on flowmeters or any other equipment that is working magnetically, even when located in hazardous areas.

The MasterEx 79784 comes with an integral test magnet that is securely fit in such a way that it cannot be easily lost. Using this magnet, tests can be carried out to establish the working state of both unit and batteries.

After any check the MasterEx 79784 will automatically switch off if it is no longer being used. This ensures a long battery life.

The clip attached to the instrument's side secures it from accidental loss and allows the maintenance engineer to easily carry it at all times.

MasterEx 79784 est un mesureur de magnétisme de la grandeur d'un stylo, dessiné pour détecter des champs magnétiques dans des zones dangereuses. En peu de secondes il est capable de détecter quelconque solénoïde qui est activé électriquement.

Il n'y a pas besoin de connexion au circuit électrique ou d'ouvrir le coffret de terminaux.

La grande sensibilité de la pointe du testeur MasterEx 79784 permet de détecter à l'approche de la bobine du solénoïde, par l'allumage d'une lumière rouge, que le champ magnétique est activé. De la même manière ce test peut s'effectuer près d'un fluxomètre ou d'autres équipements qui travaillent magnétiquement y compris quand ils sont dans des zones dangereuses.

El MasterEx 79784 est fourni avec un aimant de sécurité intégré pour qu'il ne se perde pas facilement. En utilisant cet aimant, le test peut s'effectuer pour connaître l'état de travail de l'unité et des batteries.

Après tout contrôle le MasterEx 79784 s'éteindra automatiquement s'il n'est pas utilisé durant un certain temps. Cela assure une meilleure durée de vie aux piles.

Le clip du côté de l'appareil est une sécurité contre la perte et permet à l'utilisateur de le porter facilement.

■ MEDICIÓN / MEASURING / MESURE / MESSEN / MISURE / MEDIÇÃO / ИЗМЕРЕНИЯ

Zonas / Zones

1, 2 GAS / GAZ



\* G12

COD.

79784

■ MASTEREX 79784

Para solenoides, transformadores, fluxómetros, relés en áreas peligrosas.

Propiedades:

- Alta sensibilidad
- No es necesario contacto con el objeto
- Resistente a la suciedad
- Indicador óptico

Datos Ex:

Designación ATEX:

Ⓢ Ib IIB T3 Gb

EC-Certificado de Conformidad:

PTB 01 ATEX 2018

For testing solenoid valves, relays, transformers and flow-meters in Ex-hazardous areas.

Properties:

- Highly sensitive
- No contact with test object required
- Resistant to dirt
- Indication: optical

Ex-data:

ATEX marking:

Ⓢ Ib IIB T3 Gb

EC-Certif cate of Conformlty:

PTB 01 ATEX 2018

Pour des solénoïdes, transformateurs, fluxomètres, réseaux dans des zones dangereuses.

Propriétés:

- Haute sensibilité
- Le contact avec l'objet n'est pas nécessaire
- Résistant à la saleté
- Indicateur: optique

Renseignements Ex:

Marquage ATEX:

Ⓢ Ib IIB T3 Gb

EC-Certificat de conformité:

PTB 01 ATEX 2018

ESPECIFICACIONES TÉCNICAS / TECHNICAL SPECIFICATION / DÉTAILS TECHNIQUES

Campos magnéticos detectables / Detectable magnetic fields / Champs magnétiques détectables	Alternos, directos, continuos Alternating, direct and permanent fields Alternés, directs, continus
Detección / Detection / Détection	No hay contacto con el objeto No contact with test object required Pas de contact avec l'objet
Indicación / Indication / Indication	Óptica: LED / Optical, built-in LED / Optique LED
Sensibilidad / Sensitive / Sensibilité	≥ 30 mT (millitesla)
Alimentación de energía / Power supply / Alimentation d'énergie	2 baterías estándar AAA de acuerdo al IEC LR03, NiCd bat. recargables 2 x standard batteries AAA according to IEC LR03 or NiCd rechargeable batteries 2 Piles standards AAA conforme á IEC LR03, NiCd bat. rechargeables
Clase de protección / Protection class / Classe de protection	IP54
Designación ATEX / ATEX marking / Marquage ATEX	Ⓢ Ib IIB T3 Gb
Material de la carcasa / Casing material / Matière de la coque	Metal/punto de prueba plástico Metal/plastic probe point Metal/pointe de test plastique
Temperatura de trabajo / Working temperature / Température de travail	-20 °C ... +50 °C
Temperatura de almacenaje / Storage temperature / Température de stockage	-40 °C ... +60 °C
Dimensiones / Dimensions / Dimensions	150 x Ø18 mm
Peso / Weight / Poids	60 g (baterías incluidas) 60 g (batteries included) 60 g (piles incluses)

■ MEDICIÓN / MEASURING / MESURE / MESSEN / MISURE / MEDIÇÃO / ИЗМЕРЕНИЯ

**MEDIDOR DE TEMPERATURA SIN CONTACTO**  
**INTRINSICALLY-SAFE NON-CONTACT TEMPERATURE METER**  
**THERMOMÈTRE À DISTANCE SANS CONTACT**  
**EX-SICHERES BERÜHRUNGSGLOSES TEMPERATURÜESSGERÄT**  
**MISURATORE DI TEMPERATURA SENZA CONTATTO**  
**TERMÓMETRO SEM CONTACTO**  
**ВЗРЫВОБЕЗОПАСНЫЙ БЕЗКОНТАКТНЫЙ ТЕРМОМЕТР**



■ MASTEREX 79502

El equipo MasterEx 79502 para mediciones de temperatura sin contacto intrínsecamente seguro es un robusto instrumento fácil y manejable en áreas peligrosas.

*The intrinsically-safe non-contact temperature measuring equipment MasterEx 79502 is a robust yet exceedingly handy and easy to use instrument for temperature measuring in hazardous areas.*

Le thermomètre à distance MasterEx 79502 intrinsèquement sécuritaire est un robuste et très petit appareil manportable pour mesurer les températures dans des zones à risque.

**ESPECIFICACIONES TÉCNICAS / TECHNICAL SPECIFICATION / DÉTAILS TECHNIQUES**

Rango de temperatura / Temperature range / Echelle de température	-18 °C - +400 °C (0 °F - +752 °F)
Protección IP / IP protection / Protection IP	IP2X
Tiempo de respuesta / Response time / Temps de réponse	500 ms
Emisibilidad / Emissivity / Emission	Ajuste 0,95 Preset 0,95 Preset 0,95
D/L óptico / Optics D/L / Optique D/L	= 1/8
Respuesta espectral / Spectral response / Réponse spectrale	7-18 µm
Rango ambiental de operación / Ambient operating range / Champ d'action ambiant	0 °C...+50 °C
Rango de temperaturas de almacenamiento / Storage temperature range / Température de stockage	-20 °C... +65 °C
Humedad relativa / Relative humidity / Humidité relative	10-95% (>30 °C) sin condensación 10-95% (>30 °C) non condensing 10-95% (>30 °C) sans condensation
Alimentación de energía / Power supply / Alimentation d'énergie	9 V alkaline - IEC 6LR61
Resolución / Resolution / Résolution	0,2 °C
Señalización del objetivo / Target sighting / Pointage de la cible	Laser (tipo II) Laser (class II) Laser (type II)
Precisión (a 23 °C) / Accuracy (at 23 °C) / Exactitude (à 23 °C)	-18 °C...-1 °C ±3 °C -1 °C...+400 °C ±2 °C or ±2%
Repetibilidad / Repeatability / Répétabilité	±2 °C or 2%
Designación ATEX / ATEX marking / Marquage ATEX	⊕ II 2 G Ex ia op is IIC T4 0°C<Ta<50°C
Dimensiones / Dimensions / Dimensions	150 x 100 x 38 mm
Peso / Weight / Poids	~200 g

\* G12: GARANTÍA 12 MESES / 12 MONTHS OF WARRANTY / 12 MOIS DE GARANTIE / 12 MONATEN GARANTIE / 12 MAANDEN GARANTIE / 12 MESI DI GARANZIA / 12 МЕСЯЦЕВ ГАРАНТИЯ

■ MEDICIÓN / MEASURING / MESURE / MESSEN / MISURE / MEDIÇÃO / ИЗМЕРЕНИЯ

Zonas / Zones

1, 2 GAS / GAZ



\* G12

COD.

79502

■ MASTEREX 79502

**Beneficios de la medición sin contacto**

Aumenta la seguridad cuando se determina la temperatura a objetos en movimiento o sin antenas. Significa que el calor por fricción no afecta a la medición. No deja marcas ni imperfecciones al ser el objeto medido.

**Tiempo de respuesta**

Rápida y exacta. La respuesta pirométrica que emite energía es de 20 a 1000 veces más rápida que los termómetros tradicionales de contacto directo.

**Para mediciones de temperatura sin contacto y monitorización de temperatura en áreas peligrosas**

- Gran exactitud
- Operaciones simples
- Rápida respuesta
- Señalización del objeto por láser
- Medida en la Zona 1 y 2

**Datos Ex:**

**Designación ATEX:**

Ⓜ II 2 G Ex ia op is IIC T4 0°C < Ta < 50°C

**EC-Certificado de continuidad:**

EPS 10 ATEX 1 242X

**Bajo mantenimiento y no agresivo**

- El procedimiento no afecta a la temperatura del objeto que está siendo medido.
- El hecho de que no haya contacto del detector significa que no hay riesgo por contacto.
- No es necesario fijar o sujetar puntos sobre el objeto o el equipo.

**Para alcanzar objetivos difíciles y objetos en movimiento**

- La óptica del pirómetro se dirige al objeto que va a medir y con la señal de láser es posible apuntar objetos pequeños y distantes.
- Los materiales peligrosos y agresivos pueden ser medidos con seguridad sin miedo a dañar el equipo. El tamaño compacto del pirómetro permite que se pueda usar incluso en posiciones de mucha dificultad, sólo es necesario que exista una línea clara desde la señal al objetivo. Con la medición por contacto directo la capacidad de calor o la conducción de calor del objeto puede transferir un escaso flujo de calor al aparato de medida.

**The benefits of non-contact measurement**

Increased safety when determining the temperature of fast moving objects. No antennas mean that frictional heat cannot affect the measurement. No mark or blemish is left on the object being measured.

**Response time**

Fast and accurate. Pyrometers respond to emitted energy and are around 20 to 1000 times quicker than traditional direct contact thermometers.

**For non-contact temperature measurement and monitoring of temperature processes in Ex-hazardous areas**

- High accuracy
- Simple operation
- Quick response time
- Laser target sighting
- Measure in Zone 1 and 2

**Ex-data:**

**ATEX marking:**

Ⓜ II 2 G Ex ia op is IIC T4 0°C < Ta < 50°C

**EC-Certificate of Conformity:**

EPS 10 ATEX 1 242X

**Low maintenance and non invasive**

- The temperature of the object being measured is not affected by the procedure.
- Non contact of the detector means no wear and tear.
- No fixing or fastening points required on either the object or equipment.

**Hard to reach objects and moving materials**

- The optics of the pyrometer are aimed at the object to be measured and with the laser sighting it is possible for both small and distant objects to be targeted.
- Hazardous and aggressive materials can be safely measured - and without fear of damaging the equipment. The compact size of the pyrometer allows it to be used in even the most awkward positions, with only a clear line of sight to the target area being required. With direct contact measurement, poor heat conduction or heat capacity of the object can prevent insufficient heat flow to a measuring device.

**Les bénéfices d'un appareil de mesure à distance**

Il augmente la sécurité lors de la mesure d'objets mobiles. Les antennes n'empêchent pas la prise de température. Pas de marque, ni de défaut ne peuvent gêner la mesure.

**Temps de réponse**

Rapide et précise. Les pyromètres répondent à l'énergie dégagée et sont plus rapides entre 20 à 1000 fois que les traditionnels thermomètres de contact.

**Pour une mesure de température à distance en évitant le contact avec l'appareil de test dans les zones à risques**

- Grande exactitude
- Simple d'utilisation
- Réponse rapide
- Pointage de la cible par laser
- Mesure en zone 1 et 2

**Renseignements Ex:**

**Marquage ATEX:**

Ⓜ II 2 G Ex ia op is IIC T4 0°C < Ta < 50°C

**EC-Certificat de conformité:**

EPS 10 ATEX 1 242X

**Petit entretien et sans intervention**

- La température de l'objet étant mesurée elle n'est pas affectée.
- L'absence de contact fait éviter l'usure et les accrocs.
- Aucune fixation n'est nécessaire pour chacun des objets ou équipements.

**Difficulté d'atteindre des objets ou des matériaux en mouvement**

- Les optiques du pyromètre pointent l'objet à mesurer et avec la vise laser il est possible de pointer des objets petits et distants.
- Des matériaux à risque peuvent être mesurés en sécurité sans dommage pour l'équipement. La forme compacte du pyromètre lui permet une utilisation dans les positions les plus inconfortables avec une visée claire. Avec une mesure par contact, la faible chaleur de conduction ou de potentiel de l'objet peuvent empêcher une bonne mesure.

■ MEDICIÓN / MEASURING / MESURE / MESSEN / MISURE / MEDIÇÃO / ИЗМЕРЕНИЯ

**MULTÍMETRO DIGITAL INTRÍNSECAMENTE SEGURO**  
**INTRINSICALLY - SAFE DIGITAL MULTIMETER**  
**MULTIMÈTRE DIGITAL INTRINSÈQUEMENT SÛR**  
**EX-GESCHÜTZTER DIGITALE MULTIMETER**

**MULTIMETRO DIGITALE INTRINSICAMENTE SICURO**  
**MULTIMETRO DIGITAL INTRINSECAMENTE SEGURO**  
**ВЗРЫВОБЕЗОПАСНЫЙ ЦИФРОВОЙ МУЛЬТИМЕТР**

■ **MASTEREX 79630**



El Multímetro Digital MasterEx 79630 es un multímetro digital de 50.000 puntos TRMS especialmente diseñado para trabajar con seguridad en atmósferas peligrosas o explosivas de gas o polvo, cumpliendo con las normas EN 50014, EN 50020 y EN50281-1-1.

Además cumple con las siguientes especificaciones:

- Directiva ATEX 94/9/CE
- EN/IEC 60079-0 – EN/IEC 60079-11
- EN/IEC 61241-11 – EN/IEC 61241-0
- EN/IEC 61010-1 – 600 V CAT III

Su IP 67, proporciona gran protección contra la penetración de polvo y agua.

*MasterEx 79630 Digital Multimeter is a digital multimeter with 50.000 TRMS points designed for use in explosive "gas" or "dust" environments, in compliance with the EN 50014, 50020 and 50281-1-1 standards.*

*It also complies with the following specifications:*

- ATEX 94/9/CE directive
- EN/IEC 60079-0 – EN/IEC 60079-11
- EN/IEC 61241-11 – EN/IEC 61241-0
- EN/IEC 61010-1 – 600 V CAT III

*Its IP 67, provides high protection against dust and water penetration.*

Le Multimètre Digital MasterEx 79630 est un multimètre digital de 50.000 points TRMS conçu spécialement pour travailler en toute sécurité dans des atmosphères dangereuses ou explosives incluant les gaz et la poussière, et respectant les normes EN 50014, EN50020 et EN50281-1-1.

Il respecte également les spécifications suivantes :

- Directive ATEX 94/9/CE
- EN/IEC 60079-0 – EN/IEC 60079-11
- EN/IEC 61241-11 – EN/IEC 61241-0
- EN/IEC 61010-1 – 600 V CAT III

Jouissant d'un grand ratio de protection, IP67, il fournit une grande protection contre la pénétration de poussière et d'eau..

**Designación ATEX:**

Ⓜ II 2 GD ó Ⓜ IM 2: Ex ib I,  
Ex ib IIC T5, T4, T3  
(Dependiendo de las pilas - indicado  
en el libro de instrucciones)  
Ex ib D 21T

**Seguridad:**

IEC 61010-1 600V CAT III

**ATEX marking:**

Ⓜ II 2 GD ó Ⓜ IM 2: Ex ib I,  
Ex ib IIC T5, T4, T3  
(Depending on the batteries - as indicated  
in the instruction manual)  
Ex ib D 21T

**Safety:**

IEC 61010-1 600V CAT III

**Marquage ATEX:**

Ⓜ II 2 GD ó Ⓜ IM 2: Ex ib I,  
Ex ib IIC T5, T4, T3  
(En fonction des piles - indiqué dans  
la notice d'instructions)  
Ex ib D 21T

**Sécurité:**

IEC 61010-1 600V CAT III

**EQUIPADO CON / EQUIPED WITH / EQUIPE**

Estuche de transporte / Carrying case / Valise de transport

Batería 9V / 9V battery / Batterie 9V

Juegos de cables puntas de prueba de seguridad / Set of safety test-probe leads / Jeux de câbles à pointes pour test de sécurité

Fusible de recambio de seguridad intrínseca / Spare intrinsic-safety fuse / Fusible de rechange de sécurité intrinsèque

Manual de instrucciones / Operating instruction / Manuel d'instructions

\* **G12:** GARANTÍA 12 MESES / 12 MONTHS OF WARRANTY / 12 MOIS DE GARANTIE / 12 MONATEN GARANTIE / 12 MAANDEN GARANTIE / 12 MESI DI GARANZIA / 12 МЕСЯЦЕВ ГАРАНТИЯ



**MEDICIÓN / MEASURING / MESURE / MESSEN / MISURE / MEDIÇÃO / ИЗМЕРЕНИЯ**
**Zonas / Zones**

 1, 2 GAS / GAZ  
 M2 MINERÍA / MINING / MINIÈRE  
 21, 22 POLVO / DUST / POUSSIÈRE

\* G12



COD.

**79630**
**MASTEREX 79630**
**ESPECIFICACIONES TÉCNICAS / TECHNICAL SPECIFICATION / DÉTAILS TECHNIQUES**

Autonomía / <i>Autonomy</i> / Autonomie	300 h
Resolución / <i>Resolution</i> / Résolution	50000 cuentas / <i>50000 counts</i> / 50000 comptes
Tensión DC: Rango / <i>DC voltage: Range</i> / Tension DC: Plage	5 calibres de 500 mV a 600 V / <i>5 calibres from 500 mV to 600 V</i> / 5 calibres de 500 mV á 600 V
Tensión DC: Precisión / <i>DC voltage: Accuracy</i> / Tension DC: Précision	0,025 %
Tensión AC: Rango / <i>AC voltage: Range</i> / Tension AC: Plage	5 calibres de 500 mV a 600 V / <i>5 calibres from 500 mV to 600 V</i> / 5 calibres de 500 mV á 600 V
Tensión AC: Precisión / <i>AC voltage: Accuracy</i> / Tension AC: Précision	0,03 %
Tensión AC: Banda pasante / <i>AC voltage: Bandwidth</i> / Tension AC: Bande passante	50 kHz
Corriente DC: Rango / <i>DC current: Range</i> / Courant DC: Plage	500 µA, 5 mA, 50 mA & 500 mA
Corriente DC: Precisión / <i>DC current: Accuracy</i> / Courant DC: Précision	0,2 %
Corriente AC: Rango / <i>AC current: Range</i> / Courant AC: Plage	500 µA, 5 mA, 50 mA & 500 mA
Corriente AC: Precisión / <i>AC current: Accuracy</i> / Courant AC: Précision	0,6 %
Corriente AC: Banda pasante / <i>AC current: Bandwidth</i> / Courant AC: Bande passante	5 kHz
Frecuencia: Rango / <i>Frequency: Range</i> / Fréquence: Plage	0,62 Hz - 500 kHz
Frecuencia: Precisión / <i>Frequency: Accuracy</i> / Fréquence: Précision	0,03 %
Resistencia: Rango / <i>Resistance: Range</i> / Resistance: Plage	6 escalas de 500 Ω a 50 Ω / <i>6 ranges from 500 Ω to 50 Ω</i> / 6 gammes de 500 Ω á 50 Ω
Resistencia: Precisión / <i>Resistance: Accuracy</i> / Resistance: Précision	0,07 %
Continuidad sonora: umbral de detección / <i>Continuity: detection threshold</i> / Continuité sonore: seuil de détection	10 Ω - 20 Ω
Continuidad sonora: tiempo de respuesta / <i>Continuity: response time</i> / Continuité sonore: temps de réponse	1 ms
Test diodos / <i>Diode test</i> / Test diode	0 - 2 V
Designación ATEX / <i>ATEX marking</i> / Marquage ATEX	⊕ II 2 GD ó ⊕ IM 2: Ex ib I, Ex ib IIC T5, T4, T3 (Dependiendo de las pilas - indicado en el libro de instrucciones / <i>Depending on the batteries - as indicated in the instruction manual</i> / En fonction des piles - indiqué dans la notice d'instructions) Ex ib D 21T
Capacidad / <i>Capacity</i> / Capacité	7 escalas de 50 nF a 50 mF / <i>7 ranges from 50 nF to 50 mF</i> / 7 gammes de 50 nF á 50 mF
Otras medidas / <i>Other measurements</i> / Autres mesures	Ciclo de trabajo - Función dB y potencia resistiva U2/R- Longitud de pulso - Cronómetro - Recuento de eventos / <i>Duty cycle - dB function and U2/R resistive power - Pulse width - Timer - Event counter</i> / Rapport cyclique - Fonction dB et puissance résistive U2/R - Largeur d'impulsion - Chronomètre - Comptage d'événements
Temperatura / <i>Temperature</i> / Température	-200 °C a +800 °C / Pt100 ó Pt1000
Suministro eléctrico / <i>Power supply</i> / Distribution électrique	1 x 9 V
Clase de protección / <i>Protection class</i> / Classe de protection	IP67
Dimensiones / <i>Dimensions</i> / Dimensions	189 x 82 x 40 mm
Peso / <i>Weight</i> / Poids	400 g
Barra gráfica / <i>Bargraph</i> / Bargraphe	Análoga 34 segmentos 20 med/s / <i>34-segment rapid analogue bargraph 20 meas/s</i> / Analogique 34 segments 20 med/s

■ ILUMINACIÓN / LIGHTING / ÉCLAIRAGE / BELEUCHTUNG / ILLUMINAZIONE / ILUMINAÇÃO / ОСВЕЩЕНИЕ

**FOCO LED INTRÍNECAMENTE SEGURO**  
**INTRINSICALLY SAFE LED HAND LAMP**  
**PROJECTEUR LED INTRINSÈQUEMENT SÛR**  
**EIGENSICHERE LED-HANDLEUCHE**

**RIFLETTORE A LED INTRÍNECAMENTE SEGURO**  
**HOLOFOTE LED INTRINSÈQUEMENT SEGURO**  
**ВЗРЫВОЗАЩИЩЕННЫЙ СВЕТОДИОДНЫЙ ФОНАРЬ**

■ **MASTEREX 79732 & 79733**



Los focos LED MasterEx 79732 y 79733 están especialmente diseñados para la iluminación de grandes espacios en zonas Ex. Las dos posiciones de intensidad del LED (50% Y 100%) permiten adaptar la intensidad de la luz emitida. Los focos son aptos para su uso en zonas 1 y 21.

El cuerpo permite una rotación de 180° facilitando la orientación del haz luminoso.

El cable de 10 m facilita el movimiento del foco desde la toma de corriente hasta la zona de trabajo.

Su carcasa de fundición de aluminio le confiere una gran resistencia y protección, asegurando su funcionamiento incluso en las condiciones de uso más extremas.

Además el asa en la carcasa permite un transporte del foco cómodo y seguro.

El foco LED MasterEx 79733 está especialmente indicado para los ambientes explosivos en los que se necesita una potente iluminación pero se carece de una toma eléctrica cercana. Su batería de litio ofrece una autonomía de hasta 6 horas con una sola carga.

*The MasterEx 79732 and 79733 hand lamps are specially designed to (illuminate) light large spaces in hazardous areas. The two LED modes (50% and 100% output) allow to adapt the intensity of the emitted light. The lamps are suitable for use in zones 1 and 21.*

*It is possible to rotate the body 180° in order to guide the light beam.*

*The 10 m length cable facilitates the movement of the hand lamp from the electric supply to the working area.*

*Its die casted aluminum housing grants it a huge resistance and protection, assuring the correct functioning even in the hardest conditions.*

*The handle on the housing allows the transport of the lamp in an easy and safer way.*

*The MasterEx 79733 is specially indicated for the hazardous areas in which is necessary a powerful illumination but there is no electric supply. Its lithium battery assures 6 h of usage with one charge.*



Les projecteurs LED MasterEx 79732 & 79733 ont été spécialement conçus pour l'éclairage des grands espaces en zones Ex. Les deux positions du LED (50% et 100%) permettent d'adapter l'intensité de la lumière qui en jaillit. Les projecteurs sont adaptés pour un usage en zones 1 et 21.

Le corps permet une rotation de 180°, ce qui facilite l'orientation du projecteur lumineux.

Le câble de 10m facilite le maniement de la lampe, de la prise de courant jusqu'à la zone de travail.

Le boîtier en fonte d'aluminium permet une meilleure résistance et protection, qui assure son fonctionnement optimal dans les conditions d'utilisation plus extrêmes.

De plus, la poignée permet un maniement plus sûr et confortable.

Le projecteur LED MasterEx 79733 est spécialement adapté pour les environnements explosifs dans lesquels il y a besoin d'un éclairage puissant mais sans prise électrique proche. Sa batterie lithium offre une autonomie allant jusqu'à 6 heures, avec une seule charge.

■ **ACCESORIOS / ACCESSORIES / ACCESSOIRES / ERSATZTEILE / ACCESSORI / ACESSORIOS / ЗАПАСНЫЕ ЧАСТИ**

COD.	Descripción / Description / Description	o.d. mm	Kg
<b>79670</b>	Trípode / Tripod / Trépied	1200	6,0

**ESPECIFICACIONES TÉCNICAS / TECHNICAL SPECIFICATION / DÉTAILS TECHNIQUES**

Soporte / Support / Support	1,35-3 m
Máx. capacidad de carga / Max. weight capacity / Capacité maximum de charge	10 Kg

\* **G12:** GARANTÍA 12 MESES / 12 MONTHS OF WARRANTY / 12 MOIS DE GARANTIE / 12 MONATEN GARANTIE / 12 MAANDEN GARANTIE / 12 MESI DI GARANZIA / 12 МЕСЯЦЕВ ГАРАНТИЯ

■ ILUMINACIÓN / LIGHTING / ÉCLAIRAGE / BELEUCHTUNG / ILLUMINAZIONE / ILUMINAÇÃO / ОСВЕЩЕНИЕ

Zonas / Zones

1, 2 GAS / GAZ  
21-22 POLVO / DUST / POUSSIÈRE



\* G12

COD.

79732	Con toma eléctrica / Outlet with cable / Avec prise électrique
79733	Litio / lithium / Lithium



Cable de carga (para el cod. 79733)

- Longitud: 10 m
- Alimentación: 100-240 V 50/60 Hz con enchufe europea
- Peso: 460 gr

Charging cable (for cod. 79733)

- Length: 10 m
- Power supply: 100-240 V 50/60 Hz with european plug
- Weight: 460 gr

Câble de charge (pour le code 79733)

- Longueur: 10m
- Alimentation: 100-240 V 50/60 Hz avec prise européenne
- Poids: 460 gr

ESPECIFICACIONES TÉCNICAS / TECHNICAL SPECIFICATION / DÉTAILS TECHNIQUES

LED con 2 posiciones / 2 mode LED / LED avec deux positions	100% & 50%
Luminosidad / Brightness / Luminosité	
79732	2500/1250 lm
79733	1500/750 lm
Potencia / Power / Puissance	
79732	25 W
79733	14 W
Ciclo de vida / Lifecycle / Cycle de vie	>=50000 h
Alimentación / Power supply / Alimentation	100-240 V - 50/60 Hz
Longitud del cable / Cable length / Longueur du câble	10 m con enchufe europeo / 10 m with european plug / 10 m avec prise européenne
Grado de protección / Ingress protection / Grade de protection	IP 67
Carcasa / Housing / Carcasse	Función de aluminio / Aluminum casting / Fonte en Aluminium
Posicionamiento / Positioning / Positionnement	Giratorio 180° / 180° rotation / Rotatif 180°
Asa de transporte en la carcasa / Transport handle in the housing / Poignée de transport sur le boîtier	•
Batería / Battery / Batterie	
79732	-
79733	19,2V / 1400 mAh Lithium
Tiempo de carga / Charge time / Temps de recharge	
79732	-
79733	2 h
Indicador de carga / Charging indicator / Indicateur de charge	
79732	-
79733	Rojo-cargando & Verde-cargado / Red - Charging & Green - Charged / Rouge-En charge & Vert-chargé
Cable de carga incluido / Charging cable included / Câble de recharge fourni	
79732	-
79733	•
Autonomía / Autonomy / Autonomie	
79732	-
79733	3 h-6 h
Designación ATEX / ATEX marking / Marquage ATEX	Ⓜ II 2 G Ex demb IIC T4 Gb Ⓜ III 2D Ex tb IIIC T85° Db
Dimensiones / Dimensions / Dimensions	230 x 230 x 110 mm
Peso / Weight / Poids	
79732	4,55 kg
79733	3,95 kg
Accesorios incluidos / Accessories Included / Accessoires inclus	Cable de carga / Charging cable / Câble de charge
79733	

■ ILLUMINACIÓN / LIGHTING / ÉCLAIRAGE / BELEUCHTUNG / ILLUMINAZIONE / ILUMINAÇÃO / ОСВЕЩЕНИЕ

LINTERNA PARA INSPECCIÓN INTRÍNECAMENTE SEGURA  
INTRINSICALLY SAFE INSPECTION LAMP  
TORCHE D'INSPECTION INTRINSÈQUEMENT SÛRE  
EIGENSICHERE KONTROLLAMPE

TORCIA PER ISPEZIONE INTRINSECAMENTE SICURA  
LANTERNA DE INSPEÇÃO INTRINSECAMENTE SEGURA  
ВЗРЫВОЗАЩИЩЕННЫЙ ФОНАРЬ ДЛЯ ОСМОТРОВ

■ MASTEREX 79731



La linterna LED MasterEx 79731 resulta idónea para iluminar zonas de trabajo en ambientes explosivos peligrosos. Su batería de litio proporciona una autonomía de hasta 6 h, y está diseñada específicamente para resistir las condiciones industriales de trabajo diario. Resulta una opción ideal para su uso en ambientes explosivos peligrosos.

Sus dos focos LED permiten una iluminación adecuada en todas las condiciones de utilización. El LED frontal tiene dos modos de intensidad, proporcionando de 150 a 300 lumens. El LED superior emite un haz de luz de 100 lumens.

Ya sea fijada mediante la base magnética o colgada a través de su gancho de 360°, su diseño permite el posicionamiento adecuado para iluminar las zonas de trabajo sin necesidad de sujetarla manualmente. El clip trasero permite al usuario su cómodo transporte.

El indicador de carga en la parte trasera informa del estado de la batería.

Su carcasa de plástico antiestático le confiere un alto grado de protección mientras que facilita un agarre seguro y confortable.

*The MasterEx 79731 inspection lamp is the ideal solution for illuminating working zones in hazardous areas. Its lithium battery provides a 6 h usage and it is specially designed to stand the daily industrial working conditions. It is the best solution for the hazardous areas.*

*Its two LED lights allow a proper illumination for all the working conditions. The front LED has two output modes, providing 150 to 300 lumen. The top LED gives a 100 lumen beam.*

*Its design allows proper positioning to illuminate working areas with no need to hold it manually by its magnetic holder or the 360° hanging hook. The clip in the rear allows an easy transport.*

*The charge indicator in the back side of the lamp provides information about the charge status.*

*Its antistatic plastic housing grants a high protection grade as well as permits the handling of the lamp.*

La lampe LED MasterEx 79731 est idéale pour éclairer les zones de travail en environnements explosifs et dangereux. Sa batterie lithium offre jusqu'à 6 heures d'autonomie, et a été conçue pour résister aux conditions industrielles de travail au quotidien. C'est le matériel idéal pour une utilisation en environnements explosifs et dangereux.

Ses deux projecteurs LED permettent un éclairage optimal quelque soient les conditions d'utilisation. Le LED frontal est configuré à deux modes d'intensité allant de 150 à 300 lumens. Le LED supérieur émet un projecteur lumineux de 100 lumens.

Qu'elle soit fixée sur une base magnétique ou suspendue à un crochet de 360°, son élaboration permet un positionnement optimal pour éclairer las zones de travail sans avoir besoin de la porter à la main. Le clip au dos permet à l'utilisateur de la transporter sans gêne.

L'indicateur de charge au dos indique l'état de la batterie.

Son boîtier en plastique antistatique lui confère un niveau de protection élevé, ainsi qu'une facilité de transport plus sûre et confortable.



■ ILLUMINACIÓN / LIGHTING / ÉCLAIRAGE / BELEUCHTUNG / ILLUMINAZIONE / ILUMINAÇÃO / ОСВЕЩЕНИЕ

Zonas / Zones

1, 2 GAS / GAZ  
21-22 POLVO / DUST / POUSSIÈRE



\* G12

COD.

79731

litio / lithium / lithium

■ MASTEREX 79731

**Base de carga (cod. 79716)**

- Medidas: 110x100x90 mm
- Peso: 125 g
- Posibilidad de anclaje a la pared

**Cable de carga (cod. 79717)**

- Longitud: 1 m
- Peso: 25 g

**Cargador (cod. 79718)**

- Alimentación: 100-240 V 50/60 Hz con enchufe europeo
- Peso: 45 g

**Charging station (cod. 79716)**

- Measures: 110x100x90 mm
- Weight: 125 g
- Suitable for wall mounting

**Charging cable (cod. 79717)**

- Length: 1 m
- Weight: 25 g

**Charger (cod. 79718)**

- Power supply: 100-240 V 50/60 Hz with european plug
- Weight: 45 g

**Base de charge (code 79716)**

- Mesures: 110x100x90 mm
- Poids: 125 gr
- Possibilité d'ancrage dans le mur

**Câble de charge (code 79717)**

- Longueur: 1 m
- Poids: 25 g

**Chargeur (code 79718)**

- Alimentation: 100-240 V 50/60 Hz avec prise européenne
- Poids: 45 g

ESPECIFICACIONES TÉCNICAS / TECHNICAL SPECIFICATION / DÉTAILS TECHNIQUES

2 focos LED / 2 LED lights / 2 projecteurs LED	●
LED frontal 2 posiciones / 2 mode front LED / LED frontal à deux positions	100% & 50%
LED superior 1 posición / 1 mode top LED / LED supérieur une position	100%
Luminosidad / Brightness / Luminosité	300/150 lm LED frontal - 100 lm LED superior 300/150 lm frontal LED - 100 lm top LED 300/150 lm LED frontal - 100 lm LED supérieur
Potencia / Power / Puissance	2,5 W
Ciclo de vida / Lifecycle / Cycle de vie	>=50000 h
Alimentación / Power supply / Alimentation	100-240 V - 50/60 Hz
Grado de protección / Ingress protection / Grade de protection	IP 54
Carcasa / Housing / Carcasse	Plástico antiestático / Anti-static plastic / Plastique antistatique
Gancho / Hook / Crochet	Giratorio 360° / 360° Rotation / Rotatif à 360°
Fijación magnética / Magnetic holder / Fixation magnétique	●
Base de carga y cargador incluido / Charging base and charger included / Base de charge et chargeur inclus	1 m con enchufe europeo 1 m with european plug 1 m avec prise européenne
Batería / Battery / Batterie	3,2V / 2800 mAh Lithium
Tiempo de carga / Charge time / Temps de recharge	3,5 h
Autonomía / Autonomy / Autonomie	3 h-6 h
Designación ATEX / ATEX marking / Marquage ATEX	Ⓢ II 2 G Ex ib IIC T4 Gb Ⓢ III 2D Ex tb IIC T85° Db
Dimensiones / Dimensions / Dimensions	220 x 70 x 40 mm
Peso / Weight / Poids	400 g
Accesorios incluidos / Accessories Included / Accessoires inclus	Base de carga (cod. 79716). Cable de carga (cod. 79717). Cargador (cod. 79718) / Charging station (cod. 79716). Charging cable (cod. 79717). Charger (cod. 79718) / Base de charge (code 79716). Câble de charge (code 79717). Chargeur (code 79718)

■ ILUMINACIÓN / LIGHTING / ÉCLAIRAGE / BELEUCHTUNG / ILLUMINAZIONE / ILUMINAÇÃO / ОСВЕЩЕНИЕ

LINTERNAS INTRÍNSICAMENTE SEGURAS  
INTRINSICALLY-SAFE TORCHES  
LAMPES INTRINSÈQUEMENT SÛRES  
EX-GESCHÜTZTE TASCHENLAMPE

TORCE INTRINSICAMENTE SICUR  
LANTERNAS INTRÍNSICAMENTE SEGURAS  
ВЗРЫВОБЕЗОПАСНЫЕ ФОНАРИ

■ MASTEREX 79639 & 79640

La linterna MasterEx 79639-79640 está equipada con un led de alta potencia y un sensor de luz para ahorrar energía. Perfecta para uso en ambientes explosivos peligrosos, hasta zona 0 y 20, conjugando resistencia y potente iluminación. Adaptable a cascos de bombero.

*The MasterEx 79639-79640 is equipped with a high power led and a light sensor for saving energy. Ideal torch for hazardous areas, up to Zone 0 and 20, combining heavy-duty performance and powerful illumination. It can be mounted in fire helmets.*

La lanterne MasterEX 79639-79640 est dotée d'un led de grande puissance et d'un capteur de lumière pour économiser de l'énergie. Parfaite pour une utilisation en atmosphères explosives dangereuses, jusqu'à la zone 0 et 20, conjuguant résistance et forte luminosité. Adaptable aux casques de pompiers.



Sujeción a casco Gallet F1.  
Clip for Gallet F1.  
Fixation de casque Gallet F1.

Led de 3W / 135 Lúmenes.  
3W Led / 135 Lumens.  
3W Led / 135 Lumens.



\* G12: GARANTÍA 12 MESES / 12 MONTHS OF WARRANTY / 12 MOIS DE GARANTIE / 12 MONATEN GARANTIE / 12 MAANDEN GARANTIE / 12 MESI DI GARANZIA / 12 МЕСЯЦЕВ ГАРАНТИЯ

■ ILLUMINACIÓN / LIGHTING / ÉCLAIRAGE / BELEUCHTUNG / ILLUMINAZIONE / ILUMINAÇÃO / ОСВЕЩЕНИЕ

Zonas / Zones

0, 1, 2 GAS / GAZ  
20-21-22 POLVO / DUST / POUSSIÈRE



\* G12

COD.

79639	Pilas / Batteries / Piles
79640	Litio / Lithium / Lithium

■ ACCESORIOS / ACCESSORIES / ACCESSOIRES / ERSATZTEILE / ACCESSORI / ACESSORIOS / ЗАПАСНЫЕ ЧАСТИ

COD.		Válido para / Valid for / Valable pour
79644	Sujeción a casco de bombero Gallet F1 / Clip for Gallet F1 fire helmets / Fixation de casque de pompier Gallet F1	79640
79642	Cargador / Charger / Chargeur	79640
79643	Batería / Battery / Batterie	79640

**Cargador cod. 79642 (para cod. 79640):**

- Normativa Europea CE, e9.
- Clase de protección IP54
- Tiempo de carga: 4-5 h max.
- Desconexión a fin de carga: automática
- Estado de carga: rojo/cargando - verde/cargada
- Alimentación: DC:12V - AC: 100/240V-50/60Hz
- Tipos y dimensiones: individual / 75 x 100 x 120 mm

**Charger cod. 79642 (for cod. 79640):**

- European standard CE, e9.
- IP rating IP54.
- Charging time: 4-5h max.
- Disconnection at the end of the charge: automatic.
- Charging indication: red/charging - green/charged.
- Power supply: DC:12V - AC: 100/240V-50/60Hz
- Types and dimensions: Single / 75x100x120mm

**Chargeur cod. 79642 (pour code 79640):**

- Norme Européenne CE, e9.
- Classe de protection IP54.
- Temps de charge 4-5 h. max.
- Déconnexion en fin de charge: automatique.
- État de charge: rouge/en charge - vert/chargé.
- Alimentation: DC:12V - AC: 100/240V-50/60Hz
- Types et dimensions: Individuel / 75x100x120mm

ESPECIFICACIONES TÉCNICAS / TECHNICAL SPECIFICATION / DÉTAILS TECHNIQUES

Fuente de luz / Light source / Source de lumière	3 W Led
Luminosidad / Brightness / Luminosité	135 Lúmenes / 135 Lumens / 135 Lumens
Alimentación / Power supply / Alimentation	79639 4 x R03 AAA / 6V 79640 Li-ion / 3,7V (cod. 79643)
Gestión inteligente de consumo / Intelligent energy management / Gestion intelligente de consommation	Sensor de luz automático Light sensor for automatic switch of the light power Capteur de lumière automatique
Autonomía / Autonomy / Autonomie	4 h-30 h
Indicador de autonomía / Battery indication / Indication d'autonomie	Parpadeos al encendido Blinks at the start Cillements au debut
Clase de protección / Protection class / Classe de protection	IP67
Sujeción a casco Gallet F1 modelo nuevo incluido / Clip for Gallet F1 new model helmet included / Fixation de casque Gallet F1, nouveau modèle inclus	79639 ● 79640 -
Designación ATEX / ATEX marking / Marquage ATEX	⊕ II 1 GD Ex ia IIC T4 Ga ⊕ II 2 D Ex ia IIIC T85°C Da
Dimensiones / Dimensions / Dimensions	150 x 38 x 44 mm
Peso / Weight / Poids	79639 125 g 79640 145 g
Baterías incluidas / Batteries included / Batteries incluses	●

■ ILUMINACIÓN / LIGHTING / ÉCLAIRAGE / BELEUCHTUNG / ILLUMINAZIONE / ILUMINAÇÃO / ОСВЕЩЕНИЕ

LINTERNAS INTRÍNECAMENTE SEGURAS  
INTRINSICALLY-SAFE TORCHES  
LAMPES INTRINSÈQUEMENT SÛRES  
EX-GESCHÜTZTE TASCHENLAMPE

TORCE INTRINSICAMENTE SICUR  
LANTERNAS INTRÍNECAMENTE SEGURAS  
ВЗРЫВОБЕЗОПАСНЫЕ ФОНАРИ

■ MASTEREX 79641



La linterna MasterEx 79641 está equipada con un led blanco de potencia de 3W y uno rojo de alta intensidad que emite un destello papadeante y orientable. Perfecta para uso en ambientes explosivos peligrosos, hasta zona 0 y 20, conjugando resistencia y potente iluminación. Fabricada en resina termoplástica de alta resistencia a los impactos, las temperaturas extremas, los líquidos y sustancias corrosivas.

*The MasterEx 79641 is equipped with a 3W white power led and one red high intensity led which emits flashing and guides. Ideal torch for hazardous areas, up to Zone 0 and 20, combining heavy-duty performance and powerful illumination. Made of thermoplastic resin of high resistance to shocks, extreme temperatures, liquids and corrosive substances.*

La lanterne MasterEx 79641 est dotée d'un led blanc de 3 W. et d'un rouge de grande intensité qui produit un scintillement clignotant et orientable. Parfaite pour une utilisation en atmosphère explosives, en zones 0 et 20, conjugant résistance et luminosité intense. Fabriquée en résine thermoplastique de grande résistance aux chocs, aux températures extrêmes, aux liquides et substances corrosives.

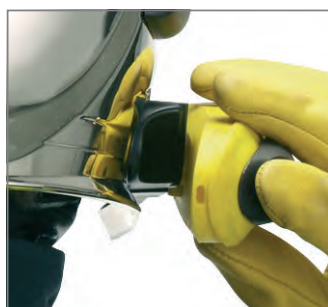

**Pulsador ergonómico**  
Facilita el encendido con  
guantes de intervención

*Ergonomic button*  
Provide the light with  
operation gloves

**Bouton ergonomique**  
Facilite l'allumage avec des  
gants d'intervention

**Led rojo**  
Red led  
Led rouge

**Cabezal rotatorio**  
Permite situar el led rojo a ambos  
lados del casco

*Rotatory head*  
Allow placing the red led in both  
helmet sides

**Tête rotative**  
Permet de situer la led rouge de  
chaques côtés du casque

**Acabado**  
Resina termoplástica superresistente

*Finishing*  
High resistance thermoplastic resin

**Finition**  
Résine thermoplastique super-résistante

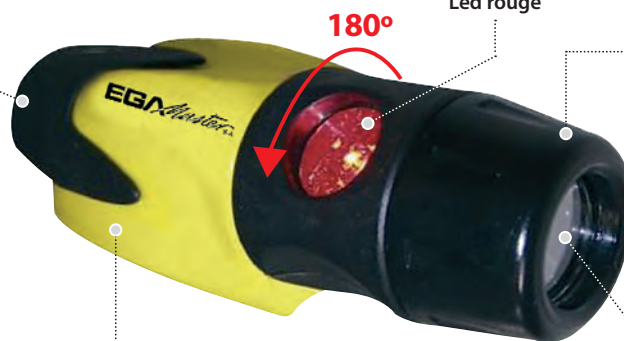

**Led blanco**  
3W alta potencia

*White led*  
3W high power

**Led blanche**  
3W grande puissance

\* G12: GARANTÍA 12 MESES / 12 MONTHS OF WARRANTY / 12 MOIS DE GARANTIE / 12 MONATEN GARANTIE / 12 MAANDEN GARANTIE / 12 MESI DI GARANZIA / 12 МЕСЯЦЕВ ГАРАНТИЯ



■ ILLUMINACIÓN / LIGHTING / ÉCLAIRAGE / BELEUCHTUNG / ILLUMINAZIONE / ILUMINAÇÃO / ОСВЕЩЕНИЕ

Zonas / Zones

0, 1, 2 GAS / GAZ  
20-21-22 POLVO / DUST / POUSSIÈRE



\* G12

COD.

79641

■ ACCESORIOS / ACCESSORIES / ACCESSOIRES / ERSATZTEILE / ACCESSORI / ACESSORIOS / ЗАПАСНЫЕ ЧАСТИ

COD.

79647	Sujeción a casco de bombero Gallet F1 / Clip for Gallet F1 fire helmets / Fixation de casque de pompier Gallet F1
79648	Sujeción a casco de bombero Gallet F2 / Clip for Gallet F2 fire helmets / Fixation de casque de pompier Gallet F2
79645	Cargador / Charger / Chargeur
79646	Batería / Battery / Batterie

**Cargador cod. 79645:**

- Normativa Europea CE, e9
- Clase de protección IP54
- Tiempo de carga: 5 h max.
- Desconexión a fin de carga: automática.
- Estado de carga: rojo/cargando - verde/cargada.
- Alimentación: DC:12V/24V - AC: 100/240V-50/60Hz
- Tipos y dimensiones: Individual / 100 x 28 x 102 mm

**Charger cod. 79645:**

- European standard CE, e9.
- IP rating IP54
- Charging time: 5h max.
- Disconnection at the end of the charge: automatic.
- Charging indication: red/charging - green/charged.
- Power supply: DC:12V/24V - AC: 100/240V-50/60Hz
- Types and dimensions: Single / 100x28x102mm

**Chargeur cod. 79645:**

- Norme Européenne CE, e9
- Classe de protection IP54
- Temps de charge: 5 h. max.
- Déconnexion en fin de charge: automatique
- État de charge: rouge/en charge - vert/chargé
- Alimentation: DC:12V/24V - AC: 100/240V-50/60Hz
- Types et dimensions: Individuel / 100 x 28 x 102 mm

ESPECIFICACIONES TÉCNICAS / TECHNICAL SPECIFICATION / DÉTAILS TECHNIQUES

Fuente de luz / Light source / Source de lumière	3 W Led
Luminosidad / Brightness / Luminosité	Led blanco, 135 Lumens - Led rojo, 27 Lumens White led, 135 Lumens - Red led, 27 Lumens Led blanche, 135 Lumens - Led rouge, 27 Lumens
Cabezal rotatorio / Rotatory head / Tête rotative	180°
Alimentación / Power supply / Alimentation	Li-ion / 3,7V
Autonomía / Autonomy / Autonomie	3 h-6 h
Indicador de autonomía / Battery indication / Indication d'autonomie	Parpadeos al encendido Blinks at the start Cillements au debut
Clase de protección / Protection class / Classe de protection	IP65
Sujeción a casco Gallet F1 modelo nuevo incluido / Clip for Gallet F1 new model helmet included / Fixation de casque Gallet F1, nouveau modèle inclus	●
Designación ATEX / ATEX marking / Marquage ATEX	Ⓢ II 1 GD Ex ia IIC T4 Ex ia D 20 IP65 T85°C Ⓢ II 2 GD Ex ia IIC T4 IP65 T85°C
Dimensiones / Dimensions / Dimensions	156 x 56 x 484 mm
Peso / Weight / Poids	180 g
Baterías incluidas / Batteries included / Batteries incluses	Li-ion / 3,7 V (cod. 79646)

**ILUMINACIÓN / LIGHTING / ÉCLAIRAGE / BELEUCHTUNG / ILLUMINAZIONE / ILUMINAÇÃO / ОСВЕЩЕНИЕ**
**Zonas / Zones**

 0, 1, 2 GAS / GAZ  
 20-21-22 POLVO / DUST / POUSSIÈRE

\* G12

 COD.  
 79595

**LINTERNAS INTRÍNECAMENTE SEGURAS**  
**INTRINSICALLY SAFE TORCHES**  
**LAMPES INTRINSÈQUEMENT SÛRES**  
**EX-GESCHÜTZTE TASCHENLAMPE**
**MASTEREX 79595**

La linterna FOCUS LED MasterEx 79595 ofrece una autonomía de 32 horas con sus 4 pilas alcalinas AA, aportando 79 lúmenes de iluminación. Su potente FOCUS LED la convierte en una linterna perfecta para uso en los ambientes de gas/polvo explosivos más peligrosos, hasta Zona 0/20, cuando se requiere de gran potencia de alumbrado, y flexibilidad, gracias a su mango acodado.

*The MasterEx 79595 FOCUS LED torch provides 32 hours of continuous work with 4 AA alkaline batteries, projecting an illumination of 79 lumens. Its powerful FOCUS LED makes it the ideal torch for the most hazardous gas/dust areas, up to Zone 0/20, when high illumination is required. Its offset handle also provides great flexibility.*

La lampe FOCUS LED MasterEx 79595 offre une autonomie de 32 heures avec ses 4 piles alcalines AA, en fournissant 79 lumens d'illumination. Son puissant FOCUS LED la transforme en lampe parfaite pour utiliser dans les environnements de gaz gaz/poussière explosifs les plus dangereux, jusqu'à la Zone 0/20, quand c'est nécessaire d'obtenir une grande puissance d'éclairage et flexibilité grâce à son manche coudé.

**TORCE INTRINSECAMENTE SICUR**  
**LANTERNAS INTRINSECAMENTE SEGURAS**  
**ВЗРЫВОБЕЗОПАСНЫЕ ФОНАРИ**
**ESPECIFICACIONES TÉCNICAS / TECHNICAL SPECIFICATION / DÉTAILS TECHNIQUES**

Temperatura ambiente Ta / Ambient temperature Ta / Température ambiante Ta	-20 °C - +50 °C
Fuente de luz / Light source / Source de lumière	1 W Focus Led
Luminosidad / Brightness / Luminosité	79 Lúmenes / 79 Lumens / 79 Lumens
Alimentación / Power supply / Alimentation	4 x AA pilas (certificadas) / 4 x AA batteries (type tested) / 4 x AA piles (certifiées)
Clase de protección / Protection class / Classe de protection	IP66
Longitud / Length / Longueur	190 mm
Designación ATEX / ATEX marking / Marquage ATEX	⊕ II 1 G Ga Ex ia IIC T4, ⊕ II 1 D Da Ex ia D 20 IP66 T83°C
Peso / Weight / Poids	297 g
Baterías incluidas / Batteries included / Batteries incluses	-

**Zonas / Zones**

 0, 1, 2 GAS / GAZ  
 20-21-22 POLVO / DUST / POUSSIÈRE

\* G12

 COD.  
 79596

**MASTEREX 79596**

La linterna LED MasterEx 79596 ofrece una autonomía de 10 horas con sus 3 pilas alcalinas AAA, aportando 60 lúmenes de iluminación. Su potente LED la convierte en una linterna perfecta para uso en los ambientes de gas/polvo explosivos más peligrosos, hasta Zona 0/20, cuando se requiere de gran potencia de alumbrado. Una solución ideal entre máxima seguridad, potente alumbrado y economía.

*The MasterEx 79596 LED torch provides 10 hours of continuous work with 3 AAA alkaline batteries, projecting an illumination of 60 lumens. Its powerful LED makes it the ideal torch for the most hazardous gas/dust areas, up to Zone 0/20, when high illumination is required. It is the ideal combination of maximum safety, powerful illumination and cost-effectiveness.*

La lampe LED MasterEx 79596 offre une autonomie de 10 heures avec ses 3 piles alcalines AAA, en fournissant 60 lumens d'illumination. Son puissant LED la transforme en lampe parfaite pour utiliser dans les environnements de gaz/poussière explosifs les plus dangereux, jusqu'à la Zone 0/20, quand c'est nécessaire d'obtenir une grande puissance d'éclairage. Une solution idéale de sécurité maximale, puissant éclairage et économie.

**ESPECIFICACIONES TÉCNICAS / TECHNICAL SPECIFICATION / DÉTAILS TECHNIQUES**

Temperatura ambiente Ta / Ambient temperature Ta / Température ambiante Ta	-20 °C - +50 °C
Fuente de luz / Light source / Source de lumière	1 W Led
Luminosidad / Brightness / Luminosité	60 Lúmenes / 60 Lumens / 60 Lumens
Alimentación / Power supply / Alimentation	3 x AAA pilas (certificadas) / 3 x AAA batteries (type tested) / 3 x AAA piles (certifiées)
Clase de protección / Protection class / Classe de protection	IP65
Longitud / Length / Longueur	71 mm
Designación ATEX / ATEX marking / Marquage ATEX	⊕ II 1 D/G Ex ia IIC T4, ⊕ II 1 D Da Ex ia D 20 IP65 T65°C
Peso / Weight / Poids	120 g
Baterías incluidas / Batteries included / Batteries incluses	●

\* G12: GARANTÍA 12 MESES / 12 MONTHS OF WARRANTY / 12 MOIS DE GARANTIE / 12 MONATEN GARANTIE / 12 MAANDEN GARANTIE / 12 MESI DI GARANZIA / 12 МЕСЯЦЕВ ГАРАНТИЯ

■ ILLUMINACIÓN / LIGHTING / ÉCLAIRAGE / BELEUCHTUNG / ILLUMINAZIONE / ILUMINAÇÃO / ОСВЕЩЕНИЕ

Zonas / Zones

1, 2 GAS / GAZ  
21-22 POLVO / DUST / POUSSIÈRE



\* G12

COD.

79590



LINTERNAS INTRÍNSECAMENTE SEGURAS  
INTRINSICALLY-SAFE TORCHES  
LAMPES INTRINSÈQUEMENT SÛRES  
EX-GESCHÜTZTE TASCHENLAMPE

■ MASTEREX 79590

La linterna Xenon MasterEx 79590 ofrece una autonomía de 2 horas con sus 2 pilas alcalinas AAA, aportando 7 lúmenes de iluminación. Su ligereza y ergonomía la convierten en una linterna perfecta para uso en ambientes de gas explosivos peligrosos, hasta Zona 1, conjugando versatilidad y eficiencia.

*The MasterEx 79590 Xenon torch provides 2 hours of continuous work with 2 AAA alkaline batteries, projecting an illumination of 7 lumens. Its light and ergonomic makes it the ideal torch for hazardous gas areas, up to Zone 1, matching versatility and cost-effectiveness.*

La lampe Xenon MasterEx 79590 offre une autonomie de 2 heures avec ses 2 piles alcalines AAA, en fournissant 7 lumens d'illumination. Sa légèreté et son ergonomie la transforment en lampe parfaite pour utiliser dans les environnements de gaz explosifs dangereux, jusqu'à la Zone 1, en associant la polyvalence et l'économie.

TORCE INTRINSICAMENTE SICUR  
LANTERNAS INTRINSECAMENTE SEGURAS  
ВЗРЫВОБЕЗОПАСНЫЕ ФОНАРИ

ESPECIFICACIONES TÉCNICAS / TECHNICAL SPECIFICATION / DÉTAILS TECHNIQUES

Temperatura ambiente Ta / Ambient temperature Ta / Température ambiante Ta	-20 °C - +50 °C
Fuente de luz / Light source / Source de lumière	1,1 W Xenon
Luminosidad / Brightness / Luminosité	7 Lúmenes / 7 Lumens / 7 Lumens
Alimentación / Power supply / Alimentation	2 x AA pilas (certificadas) / 2 x AA batteries (type tested) / 2 x AA piles (certifiées)
Clase de protección / Protection class / Classe de protection	IP67
Longitud / Length / Longueur	104 mm
Designación ATEX / ATEX marking / Marquage ATEX	Ⓢ II 2 G Ex e ib IIB T4, Ⓢ II 2 D Ex ib D 21 IP67 T100°C
Peso / Weight / Poids	45 g
Baterías incluidas / Batteries included / Batteries incluses	-

Zonas / Zones

0, 1, 2 GAS / GAZ



\* G12

COD.

79598



■ MASTEREX 79598

La linterna MasterEx 79598 ofrece una autonomía de 13 horas con sus 4 pilas alcalinas AA y está equipada con un LED de potencia 1W.

Su ligereza, ergonomía y su grado de protección IP68 la convierten en una linterna perfecta para su uso tanto en ambientes de gas explosivos peligrosos, hasta zona 0, como para uso subacuático.

*The MasterEx 79598 LED torch offers 13 hours of continuous work with 4 AA alkaline batteries and is equipped with a 1W power LED.*

*Its light, ergonomics and IP68 protection grade makes it a perfect torch for use both in hazardous gas areas, up to Zone 0, and for underwater use.*

La lampe LED MasterEx 79598 offre une autonomie de 13 heures avec ses 4 piles alcalines AA et elle est composée par un LED de puissance 1W.

Sa légèreté, ergonomie et degré de protection IP68, la transforment en lampe parfaite pour utiliser dans les environnements de gaz explosifs dangereux, jusqu'à la Zone 0, comme pour utilisation subaquatique.

ESPECIFICACIONES TÉCNICAS / TECHNICAL SPECIFICATION / DÉTAILS TECHNIQUES

Inmersión continua / Continuous immersion / Immersion continue	●
Fuente de luz / Light source / Source de lumière	Osram 1 W Led
Luminosidad / Brightness / Luminosité	60 Lúmenes / 60 Lumens / 60 Lumens
Alimentación / Power supply / Alimentation	4 x AA pilas (certificadas) / 4 x AA batteries (type tested) / 4 x AA piles (certifiées)
Clase de protección / Protection class / Classe de protection	IP68
Longitud / Length / Longueur	175 mm
Designación ATEX / ATEX marking / Marquage ATEX	Ⓢ II 1 G Ex ia IIC T4 ia D 20 T135°C
Denominación UL / UL designation / Dénomination UL	Class I Div 1 Grp ABCD, Class II Div1 Grp EFG, Class III, Temp code: T4
Peso / Weight / Poids	96 g
Baterías incluidas / Batteries included / Batteries incluses	●

■ ILLUMINACIÓN / LIGHTING / ÉCLAIRAGE / BELEUCHTUNG / ILLUMINAZIONE / ILUMINAÇÃO / ОСВЕЩЕНИЕ

LINTERNAS INTRÍNECAMENTE SEGURAS  
INTRINSICALLY-SAFE TORCHES  
LAMPES INTRINSÈQUEMENT SÛRES  
EX-GESCHÜTZTE TASCHENLAMPE

TORCE INTRINSECAMENTE SICUR  
LANTERNAS INTRINSECAMENTE SEGURAS  
ВЗРЫВОБЕЗОПАСНЫЕ ФОНАРИ



Zonas / Zones

0, 1, 2 GAS / GAZ

\* G12

COD.

79693

■ MASTEREX 79693

La linterna MasterEx 79693 ofrece una autonomía de 40 horas con sus 3 pilas 1.5V alcalinas C y está equipada con un LED Cree XP-E.

Su ligereza, ergonomía y su grado de protección IPX7 la convierten en una linterna perfecta para su uso tanto en ambientes de gas explosivos peligrosos, hasta zona 0, como para uso subacuático (inmersión temporal).

*The MasterEx 79693 LED torch offers 40 hours of continuous work with 3 1.5V C alkaline batteries and is equipped with a Cree XP-E LED.*

*Its light, ergonomics and IPX7 protection grade makes it a perfect torch for use both in hazardous gas areas, up to Zone 0, and for underwater use (temporary immersion).*

La lampe LED MasterEx 79693 offre une autonomie de 40 heures avec ses 3 piles 1.5V alcalines C et elle est composée par un LED Cree XP-E.

Sa légèreté, ergonomie et degré de protection IPX7, la transforment en lampe parfaite pour utiliser dans les environnements de gaz explosifs dangereux, jusqu'à la Zone 0, comme pour utilisation subaquatique (immersion temporaire).

ESPECIFICACIONES TÉCNICAS / TECHNICAL SPECIFICATION / DÉTAILS TECHNIQUES

Fuente de luz / Light source / Source de lumière	Cree XP-E LED
Luminosidad / Brightness / Luminosité	Baja: 30 Lúmenes / Alta: 124 Lúmenes Low: 30 Lumens / High: 124 Lumens Faible: 30 Lumens / Haute: 124 Lumens
Modo / Mode / Mode	Alta-Baja-Apagado / High-Low-Off / Haute-Faible-Éteinte
Alimentación / Power supply / Alimentation	3 x C 1.5V pilas alcalinas (certificadas) 3 x C 1.5V alkaline batteries (type tested) 3 x C 1.5V piles alcalines (certifiées)
Clase de protección / Protection class / Classe de protection	IPX7
Longitud / Length / Longueur	220 mm
Inmersión temporal / Temporary immersion / Immersion temporaire	●
Soporte / Support / Support	●
Designación ATEX / ATEX marking / Marquage ATEX	Ⓢ II 1 G Ex ia IIC T4
Denominación UL / UL designation / Dénomination UL	Class I Div 1 Grp ABCD, Class II Div1 Grp EFG, Class III, Temp code: T4
Peso / Weight / Poids	185 g
Baterías incluidas / Batteries included / Batteries incluses	●

\* G12: GARANTÍA 12 MESES / 12 MONTHS OF WARRANTY / 12 MOIS DE GARANTIE / 12 MONATEN GARANTIE / 12 MAANDEN GARANTIE / 12 MESI DI GARANZIA / 12 МЕСЯЦЕВ ГАРАНТИЯ

■ ILLUMINACIÓN / LIGHTING / ÉCLAIRAGE / BELEUCHTUNG / ILLUMINAZIONE / ILUMINAÇÃO / ОСВЕЩЕНИЕ

Zonas / Zones

0, 1, 2 GAS / GAZ



\* G12

COD.

79591



LINTERNAS INTRÍNSECAMENTE SEGURAS  
INTRINSICALLY-SAFE TORCHES  
LAMPES INTRINSÈQUEMENT SÛRES  
EX-GESCHÜTZTE TASCHENLAMPE

■ MASTEREX 79591

La linterna LED MasterEx 79591 ofrece una autonomía de 130 horas con sus 4 pilas alcalinas LR44, aportando 9 lúmenes de iluminación. Su ligereza y reducido volumen la convierten en una linterna perfecta para uso en los ambientes de gas explosivos más peligrosos.

*The MasterEx 79591 LED torch provides 130 hours of continuous work with 4 LR44 alkaline batteries, projecting an illumination of 9 lumens. Its light and small design makes it the ideal torch for the most hazardous gas areas.*

La lampe LED MasterEx 79591 offre une autonomie de 130 heures avec ses 4 piles alcalines LR44, en fournissant 9 lumens d'illumination. Sa légèreté et son petit volume la transforment en lampe parfaite pour utiliser dans les environnements de gaz explosifs les plus dangereux.

TORCE INTRINSECAMENTE SICUR  
LANTERNAS INTRINSECAMENTE SEGURAS  
ВЗРЫВОБЕЗОПАСНЫЕ ФОНАРИ

ESPECIFICACIONES TÉCNICAS / TECHNICAL SPECIFICATION / DÉTAILS TECHNIQUES

Temperatura ambiente Ta / Ambient temperature Ta / Température ambiante Ta	-20 °C - +50 °C
Fuente de luz / Light source / Source de lumière	0,2 W Led
Luminosidad / Brightness / Luminosité	9 Lúmenes / 9 Lumens / 9 Lumens
Alimentación / Power supply / Alimentation	4 x LR 44 pilas (certificadas) / 4 x LR 44 batteries (type tested) / 4 x LR 44 piles (certifiées)
Clase de protección / Protection class / Classe de protection	IP54
Longitud / Length / Longueur	67 mm
Designación ATEX / ATEX marking / Marquage ATEX	Ⓔ II 1 G Ex ia IIC T4/T6
Peso / Weight / Poids	25 g
Baterías incluidas / Batteries included / Batteries incluses	●

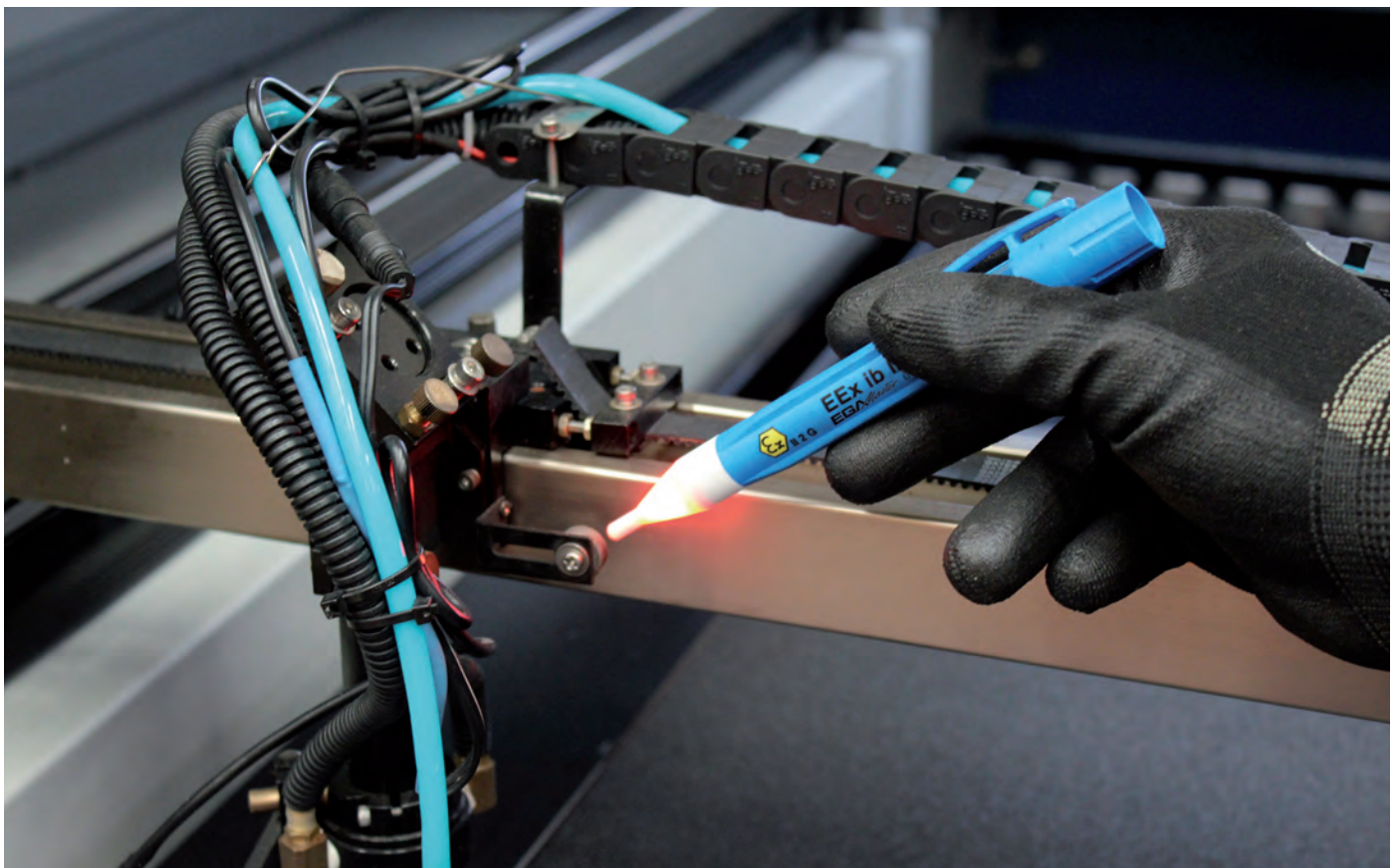

■ TALADROS / DRILLS / PERCEUSES / KLEINBOHRMASCHINE / TRAPANI / BERBEQUINS / ДРЕЛИ

Los taladros ATEX de EGA Master son robustos, potentes y muy manejables. El usuario dispone de diferentes modelos para poder escoger el que más se adapte a sus necesidades.

El taladro percutor de EGA Master está pensado para realizar taladros y perforaciones en multitud de materiales. La gran diferencia frente a un taladro normal, es la posibilidad de seleccionar un movimiento de percusión que acompañe al de rotación, facilitando enormemente la capacidad de perforación. Es imprescindible para perforar espesores muy gruesos de material de obra determinados o materiales muy duros, como el hormigón, la piedra, etc.

*EGA Master's ATEX drills are solid, powerful and very manageable. The user can choose different models that best suit his needs.*

*EGA Master Hammer drill is designed for drilling holes in several types of materials. The great difference from an ordinary drill, is the possibility of selecting a percussive movement that accompanies the rotation, greatly facilitating the drilling performance. This drill is essential to bore very thick or very hard materials such as concrete, stone, etc.*

Les perceuses ATEX sont robustes, puissantes et maniables. Différents modèles sont disponibles, adaptés à chaque travail.

Deux sélections sont disponibles (normale ou à percussion), pour optimiser le perçage. Elle est adaptée pour des perçages profonds, dans des matériaux très durs, comme le béton, la pierre, etc.

■ NEUMÁTICO / PNEUMATIC / PNEUMATIQUE / PNEUMATIK / PNEUMATICA / PNEUMÁTICO / ПНЕВМАТИЧЕСКИЕ

\* G12



COD.

79602

79603

Zonas / Zones

M2 MINERÍA / MINING / MINIÈRE

CARACTERÍSTICAS / FEATURES / CARACTÉRISTIQUES

Accesorios no incluidos / Accessories not included / Accessoires non inclus

ESPECIFICACIONES TÉCNICAS / TECHNICAL SPECIFICATION / DÉTAILS TECHNIQUES

Tipo / Type / Type	Neumático / Pneumatic / Pneumatique
Presión de trabajo / Working pressure / Pression de travail	6 bar
Portabrocas / Chuck / Mandrin	
	79602 10 mm
	79603 13 mm
Capacidad (acero) / Capacity (steel) / Capacité (acier)	
	79602 10 mm
	79603 13 mm
RPM	
	79602 1550 rpm
	79603 850 rpm
Potencia / Power / Puissance	0,5 kW
Consumo de aire / Air consumption / Consommation d'air	0,6 m <sup>3</sup> /min
Conexión / Connection / Connexion	R 1/4"i
Manguera (Øint.) / Hose (Øint.) / Tuyau (Øint.)	10 mm
Nivel sonoro / Sound level / Niveau sonore	84 db
Nivel de vibración / Vibration level / Niveau de vibration	<2,5 m/s <sup>2</sup>
Longitud / Length / Longueur	230 mm
Designación ATEX / ATEX marking / Marquage ATEX	Ⓜ I M 2 c T6
Peso / Weight / Poids	2,1 kg

\* G12: GARANTÍA 12 MESES / 12 MONTHS OF WARRANTY / 12 MOIS DE GARANTIE / 12 MONATEN GARANTIE / 12 MAANDEN GARANTIE / 12 MESI DI GARANZIA / 12 МЕСЯЦЕВ ГАРАНТИЯ

TALADROS / DRILLS / PERCEUSES / KLEINBOHRMASCHINE / TRAPANI / BERBEQUINS / ДРЕЛИ

NEUMÁTICO / PNEUMATIC / PNEUMATIQUE / PNEUMATIK / PNEUMATICA / PNEUMÁTICO / ПНЕВМАТИЧЕСКИЕ

\* G12



COD.

79904

79905

Zonas / Zones

1, 2 GAS / GAZ

CARACTERÍSTICAS / FEATURES / CARACTÉRISTIQUES

Accesorios no incluidos / Accessories not included / Accessoires non inclus

ESPECIFICACIONES TÉCNICAS / TECHNICAL SPECIFICATION / DÉTAILS TECHNIQUES

Tipo / Type / Type	Neumático / Pneumatic / Pneumatique
Presión de trabajo / Working pressure / Pression de travail	6 bar
Portabrocas / Chuck / Mandrin	
	79904 10 mm
	79905 13 mm
Capacidad (acero) / Capacity (steel) / Capacité (acier)	
	79904 10 mm
	79905 13 mm
RPM	
	79904 1550 rpm
	79905 850 rpm
Potencia / Power / Puissance	0,5 kW
Consumo de aire / Air consumption / Consommation d'air	0,6 m <sup>3</sup> /min
Conexión (entrada/salida) / Connection (inlet/outlet) / Connexion (entrée /sortie)	R 1/4" f - R 3/8" f
Manguera (Øint.) / Hose (Øint.) / Tuyau (Øint.)	≥ 10 mm
Nivel sonoro / Sound level / Niveau sonore	84 db
Nivel de vibración / Vibration level / Niveau de vibration	<2,5 m/s <sup>2</sup>
Longitud / Length / Longueur	
	79904 235 mm
	79905 245 mm
Designación ATEX / ATEX marking / Marquage ATEX	Ⓜ II 2 G c T6
Peso / Weight / Poids	2,1 kg

TALADRO CON PERCUSIÓN / IMPACT DRILL / PERCEUSE À PERCUSSION / SCHLAGBOHRMASCHINE / TRAPANO A PERCUSSIONE / BERBEQUIM DE PERCUSSÃO / УДАРНАЯ ДРЕЛЬ

\* G12



COD.

79604

Zonas / Zones

M2 MINERÍA / MINING / MINIÈRE

CARACTERÍSTICAS / FEATURES / CARACTÉRISTIQUES

Accesorios no incluidos / Accessories not included / Accessoires non inclus

ESPECIFICACIONES TÉCNICAS / TECHNICAL SPECIFICATION / DÉTAILS TECHNIQUES

Tipo / Type / Type	Neumático / Pneumatic / Pneumatique
Presión de trabajo / Working pressure / Pression de travail	6 bar
Portabrocas / Chuck / Mandrin	13 mm
Capacidad (acero) / Capacity (steel) / Capacité (acier)	13 mm
RPM	950 rpm
Potencia / Power / Puissance	0,5 kW
Consumo de aire / Air consumption / Consommation d'air	0,6 m <sup>3</sup> /min
Conexión / Connection / Connexion	R 1/4" i
Manguera (Øint.) / Hose (Øint.) / Tuyau (Øint.)	10 mm
Nivel sonoro / Sound level / Niveau sonore	84 db
Nivel de vibración / Vibration level / Niveau de vibration	<2,5 m/s <sup>2</sup>
Longitud / Length / Longueur	290 mm
Designación ATEX / ATEX marking / Marquage ATEX	Ⓜ I M 2 c T6
Peso / Weight / Poids	3,3 kg

TALADROS / DRILLS / PERCEUSES / KLEINBOHRMASCHINE / TRAPANI / BERBEQUINS / ДРЕЛИ

■ NEUMÁTICO / PNEUMATIC / PNEUMATIQUE / PNEUMATIK / PNEUMATICA / PNEUMÁTICO / ПНЕВМАТИЧЕСКИЕ

■ TALADRO CON PERCUSIÓN / IMPACT DRILL / PERCEUSE À PERCUSSION / SCHLAGBOHRMASCHINE / TRAPANO A PERCUSSIONE / BERBEQUIM DE PERCUSSÃO / УДАРНАЯ ДРЕЛЬ

\* G12 CE



COD.  
79906

Zonas / Zones

1, 2 GAS / GAZ

CARACTERÍSTICAS / FEATURES / CARACTÉRISTIQUES

Accesorios no incluidos / Accessories not included / Accessoires non inclus

ESPECIFICACIONES TÉCNICAS / TECHNICAL SPECIFICATION / DÉTAILS TECHNIQUES

Tipo / Type / Type	Neumático / Pneumatic / Pneumatique
Presión de trabajo / Working pressure / Pression de travail	6 bar
Portabrocas / Chuck / Mandrin	13 mm
Capacidad / Capacity / Capacité	13 mm (acero) - 20 mm (hormigón) 13 mm (steel) - 20 mm (concrete) 13 mm (acier) - 20 mm (béton)
RPM	950 rpm
Potencia / Power / Puissance	0,5 kW
Consumo de aire / Air consumption / Consommation d'air	0,6 m³/min
Conexión (entrada/salida) / Connection (inlet/outlet) / Connexion (entrée /sortie)	R 1/4" f - R 3/8" f
Manguera (Øint.) / Hose (Øint.) / Tuyau (Øint.)	≥ 10 mm
Nivel sonoro / Sound level / Niveau sonore	84 db
Nivel de vibración / Vibration level / Niveau de vibration	<2,5 m/s²
Longitud / Length / Longueur	300 mm
Designación ATEX / ATEX marking / Marquage ATEX	Ⓢ II 2 G c T6
Peso / Weight / Poids	3,3 kg

\* G12 CE



COD.  
79907

Zonas / Zones

1, 2 GAS / GAZ

CARACTERÍSTICAS / FEATURES / CARACTÉRISTIQUES

Accesorios no incluidos / Accessories not included / Accessoires non inclus

ESPECIFICACIONES TÉCNICAS / TECHNICAL SPECIFICATION / DÉTAILS TECHNIQUES

Tipo / Type / Type	Neumático / Pneumatic / Pneumatique
Presión de trabajo / Working pressure / Pression de travail	6 bar
Impactos por minuto / Impacts per minute / Impacts par minute	3000
Capacidad / Capacity / Capacité	28 mm (hormigón) 28 mm (concrete) 28 mm (béton)
RPM	625 rpm
Potencia / Power / Puissance	0,5 kW
Consumo de aire / Air consumption / Consommation d'air	0,6 m³/min
Conexión (entrada/salida) / Connection (inlet/outlet) / Connexion (entrée /sortie)	R 1/2" f - R 3/8" f
Manguera (Øint.) / Hose (Øint.) / Tuyau (Øint.)	≥ 10 mm
Nivel sonoro / Sound level / Niveau sonore	93 db
Adaptador / Adapter plug / Adaptateur	SDS-plus®
Nivel de vibración / Vibration level / Niveau de vibration	4,5 m/s²
Longitud / Length / Longueur	400 mm
Designación ATEX / ATEX marking / Marquage ATEX	Ⓢ II 2 G c T6
Peso / Weight / Poids	6,3 kg

\* G12: GARANTÍA 12 MESES / 12 MONTHS OF WARRANTY / 12 MOIS DE GARANTIE / 12 MONATEN GARANTIE / 12 MAANDEN GARANTIE / 12 MESI DI GARANZIA / 12 МЕСЯЦЕВ ГАРАНТИЯ



TALADROS / DRILLS / PERCEUSES / KLEINBOHRMASCHINE / TRAPANI / BERBEQUINS / ДРЕЛИ

■ NEUMÁTICO / PNEUMATIC / PNEUMATIQUE / PNEUMATIK / PNEUMATICA / PNEUMÁTICO / ПНЕВМАТИЧЕСКИЕ

\* G12 CE



COD.  
79908



Zonas / Zones

1, 2 GAS / GAZ

CARACTERÍSTICAS / FEATURES / CARACTÉRISTIQUES

Accesorios no incluidos / Accessories not included / Accessoires non inclus

ESPECIFICACIONES TÉCNICAS / TECHNICAL SPECIFICATION / DÉTAILS TECHNIQUES

Tipo / Type / Type	Neumático / Pneumatic / Pneumatique
Presión de trabajo / Working pressure / Pression de travail	6 bar
Impactos por minuto / Impacts per minute / Impacts par minute	2500
Portabrocas / Chuck / Mandrin	SDS-max
Capacidad / Capacity / Capacité	50 mm (hormigón) - 80 mm (mampostería) 50 mm (concrete) - 80 mm (masonry) 50 mm (béton) - 80 mm (maçonnerie)
RPM	250 rpm
Potencia / Power / Puissance	1,5 kW
Consumo de aire / Air consumption / Consommation d'air	1,5 m³/min
Conexión (entrada/salida) / Connection (inlet/outlet) / Connexion (entrée/sortie)	R 1/2" f - R 3/8" f
Manguera (Øint.) / Hose (Øint.) / Tuyau (Øint.)	≥ 13 mm
Nivel sonoro / Sound level / Niveau sonore	90,4 db
Nivel de vibración / Vibration level / Niveau de vibration	9,2 m/s²
Longitud / Length / Longueur	640 mm
Designación ATEX / ATEX marking / Marquage ATEX	Ⓜ II 2 G c T6
Peso / Weight / Poids	13,3 kg

TALADRO MANGO EN D / D-HANDLE DRILL / PERCEUSE MANCHE D / LUFTDRUCK-BOHRMASCHINE / TRAPANO CON MANICO A D / BERBEQUIM COM PUNHO FECHADO / ДРЕЛЬ С РУКОЯТКОЙ ТИП D

\* G12 CE



COD.  
79605



Zonas / Zones

M2 MINERÍA / MINING / MINIÈRE

CARACTERÍSTICAS / FEATURES / CARACTÉRISTIQUES

Accesorios no incluidos / Accessories not included / Accessoires non inclus

ESPECIFICACIONES TÉCNICAS / TECHNICAL SPECIFICATION / DÉTAILS TECHNIQUES

Tipo / Type / Type	Neumático / Pneumatic / Pneumatique
Presión de trabajo / Working pressure / Pression de travail	6 bar
Par / Torque / Paire	9 Nm
Portabrocas / Chuck / Mandrin	De acción rápida Quick action Action rapide
Capacidad / Capacity / Capacité	13 mm (acero) / 13 mm (steel) / 13 mm (acier)
RPM	650 rpm
Potencia / Power / Puissance	0,65 kW
Consumo de aire / Air consumption / Consommation d'air	0,68 m³/min
Conexión / Connection / Connexion	R 3/8" f
Manguera (Øint.) / Hose (Øint.) / Tuyau (Øint.)	13 mm
Nivel sonoro / Sound level / Niveau sonore	89 db
Nivel de vibración / Vibration level / Niveau de vibration	<2,5 m/s²
Designación ATEX / ATEX marking / Marquage ATEX	Ⓜ I M 2 c T6
Peso / Weight / Poids	5,7 kg

■ TALADROS / DRILLS / PERCEUSES / KLEINBOHRMASCHINE / TRAPANI / BERBEQUINS / ДРЕЛИ

■ NEUMÁTICO / PNEUMATIC / PNEUMATIQUE / PNEUMATIK / PNEUMATICA / PNEUMÁTICO / ПНЕВМАТИЧЕСКИЕ

■ TALADRO ANGULAR / CORNER DRILL / PERCEUSE D'ANGLE / LUFTDRUCK-WINKEL-BOHRMASCHINE / TRAPANO ANGOLARE / BERBEQUIM ANGULAR / УГЛОВАЯ ДРЕЛЬ

\* G12



COD.

79606



Zonas / Zones

M2 MINERÍA / MINING / MINIÈRE

CARACTERÍSTICAS / FEATURES / CARACTÉRISTIQUES

Accesorios no incluidos / Accessories not included / Accessoires non inclus

ESPECIFICACIONES TÉCNICAS / TECHNICAL SPECIFICATION / DÉTAILS TECHNIQUES

Tipo / Type / Type	Neumático / Pneumatic / Pneumatique
Presión de trabajo / Working pressure / Pression de travail	6 bar
Par / Torque / Paire	72 Nm
Portabrocas / Chuck / Mandrin	MT3
Capacidad / Capacity / Capacité	32 mm (acero) / 32 mm (steel) / 32 mm (acier)
RPM	260 rpm
Potencia / Power / Puissance	1,92 kW
Consumo de aire / Air consumption / Consommation d'air	1,80 m <sup>3</sup> /min
Conexión / Connection / Connexion	R 3/4" a
Manguera (Øint.) / Hose (Øint.) / Tuyau (Øint.)	15 mm
Nivel sonoro / Sound level / Niveau sonore	93 db
Nivel de vibración / Vibration level / Niveau de vibration	3,4 m/s <sup>2</sup>
Designación ATEX / ATEX marking / Marquage ATEX	Ⓢ I M 2 c T6
Peso / Weight / Poids	11,5 kg

■ TALADRO MAGNÉTICO / MAGNETIC CORE DRILL / PERCEUSE MAGNÉTIQUE / KERNLOCHBOHRER MIT MAGNETFUß / TRAPANO MAGNETICO / BERBEQUIM MAGNÉTICO / СТАНОК ДЛЯ ВЫРЕЗАНИЯ ОТВЕРСТИЙ НА МАГНИТНОЙ ПОДУШКЕ

\* G12



COD.

79632

79633



Zonas / Zones

1, 2 GAS / GAZ

CARACTERÍSTICAS / FEATURES / CARACTÉRISTIQUES

Accesorios no incluidos / Accessories not included / Accessoires non inclus

ESPECIFICACIONES TÉCNICAS / TECHNICAL SPECIFICATION / DÉTAILS TECHNIQUES

Tipo / Type / Type	Neumático / Pneumatic / Pneumatique
Presión de trabajo / Working pressure / Pression de travail	6 bar
Par / Torque / Paire	47,5 Nm
Portabrocas / Chuck / Mandrin	19 mm
Máximo diámetro de perforación / Maximum diameter of drilling / Diamètre maximum de perforation	53 mm
Fuerza magnética / Magnetic force / Force magnétique	800 kg
RPM	400 rpm
Potencia / Power / Puissance	1,0 kW
Consumo de aire / Air consumption / Consommation d'air	1,50 m <sup>3</sup> /min
Carrera / Stroke / Parcours	
	79632 125 mm
	79633 260 mm
Conexión / Connection / Connexion	R 3/8" f
Manguera (Øint.) / Hose (Øint.) / Tuyau (Øint.)	13 mm
Designación ATEX / ATEX marking / Marquage ATEX	Ⓢ II 2 G c T6
Peso / Weight / Poids	
	79632 19 kg
	79633 21,5 kg

\* G12: GARANTÍA 12 MESES / 12 MONTHS OF WARRANTY / 12 MOIS DE GARANTIE / 12 MONATEN GARANTIE / 12 MAANDEN GARANTIE / 12 MESI DI GARANZIA / 12 МЕСЯЦЕВ ГАРАНТИЯ

TALADROS / DRILLS / PERCEUSES / KLEINBOHRMASCHINE / TRAPANI / BERBEQUINS / ДРЕЛИ

HIDRÁULICA / HIDRAULIC / HYDRAULIQUE / HYDRAULISCH / IDRAULICA / HIDRÁULICA / ГИДРАВЛИЧЕСКИЙ

TALADRO CON PERCUSIÓN / IMPACT DRILL / PERCEUSE À PERCUSSION / SCHLAGBOHRMASCHINE / TRAPANO A PERCUSSIONE / BERBEQUIM DE PERCUSSÃO / УДАРНАЯ ДРЕЛЬ

\* G12 CE



COD.  
79915



Zonas / Zones

1, 2 GAS / GAZ

CARACTERÍSTICAS / FEATURES / CARACTÉRISTIQUES

Accesorios no incluidos / Accessories not included / Accessoires non inclus

ESPECIFICACIONES TÉCNICAS / TECHNICAL SPECIFICATION / DÉTAILS TECHNIQUES

Tipo / Type / Type	Hidráulico / Hydraulic / Hydraulique
Presión de trabajo / Working pressure / Pression de travail	80 bar
Impactos por minuto / Impacts per minute / Impacts par minute	3400
Capacidad / Capacity / Capacité	28 mm (hormigón) - 50 mm (mampostería) 28 mm (hormigón) - 50 mm (mampostería) 28 mm (béton) - 50 mm (maçonnerie)
RPM	500 rpm
Potencia / Power / Puissance	1,2 kW
Caudal hidráulico / Oil flow / Flux d'huile	15-45 l/min
Conexión / Connection / Connexion	3/4"-16UNF
Nivel sonoro / Sound level / Niveau sonore	92 db
Adaptador / Adapter plug / Adaptateur	SDS-plus®
Nivel de vibración / Vibration level / Niveau de vibration	4,5 m/s <sup>2</sup>
Longitud / Length / Longueur	460 mm
Peso / Weight / Poids	8,2 kg
Designación ATEX / ATEX marking / Marquage ATEX	Ⓜ II 2 G c T5

\* G12 CE



COD.  
79916



Zonas / Zones

1, 2 GAS / GAZ

CARACTERÍSTICAS / FEATURES / CARACTÉRISTIQUES

Accesorios no incluidos / Accessories not included / Accessoires non inclus

ESPECIFICACIONES TÉCNICAS / TECHNICAL SPECIFICATION / DÉTAILS TECHNIQUES

Tipo / Type / Type	Hidráulico / Hydraulic / Hydraulique
Presión de trabajo / Working pressure / Pression de travail	80 bar
Impactos por minuto / Impacts per minute / Impacts par minute	2300
Capacidad / Capacity / Capacité	50 mm (hormigón) - 80 mm (mampostería) 50 mm (concrete) - 80 mm (masonry) 50 mm (béton) - 80 mm (maçonnerie)
RPM	270 rpm
Potencia / Power / Puissance	1,2 kW
Caudal hidráulico / Oil flow / Flux d'huile	15-45 l/min
Conexión / Connection / Connexion	3/4"-16UNF
Nivel sonoro / Sound level / Niveau sonore	92 db
Adaptador / Adapter plug / Adaptateur	SDS-max
Nivel de vibración / Vibration level / Niveau de vibration	9 m/s <sup>2</sup>
Longitud / Length / Longueur	640 mm
Peso / Weight / Poids	14 kg
Designación ATEX / ATEX marking / Marquage ATEX	Ⓜ II 2 G c T5

■ PERFORADORA / CORE DRILL / CAROTTEUSE À BETON / ВОЙРНАММЕР / PERFORATORE / PERFURADORA / ДРЕЛЬ АЛМАЗНОГО БУРЕНИЯ

Las perforadoras de EGA Master son máquinas portátiles hidráulicas para hacer perforaciones en superficies de muy diversos materiales; piedra, ladrillo, hormigón, bloque, ... Dispone de tres velocidades de perforación y su capacidad máxima es de 160mm.

EGA Master's core drills are portable hydraulic machines that drill the surfaces made of very different materials such as stone, brick, concrete, block... They have three drilling speeds and maximum capacity of 160 mm.

Les perceurs d'EGA Master sont des machines hydrauliques portatives, pour toutes sortes de matériaux. Elles ont trois vitesses de perforation et la capacité max est de 160 mm.

■ HIDRÁULICA / HIDRAULIC / HYDRAULIQUE / HYDRAULISCH / IDRAULICA / HIDRÁULICA / ГИДРАВЛИЧЕСКИЙ

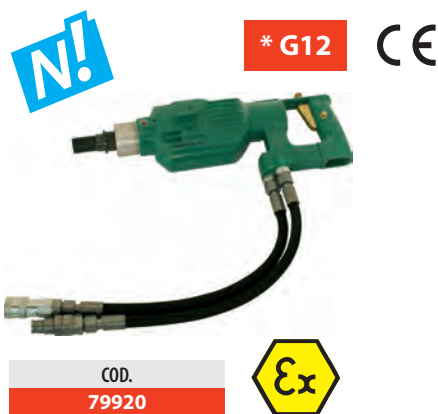

COD.

79920

Zonas / Zones

1, 2 GAS / GAZ

CARACTERÍSTICAS / FEATURES / CARACTÉRISTIQUES

Accesorios no incluidos / Accessories not included / Accessoires non inclus

ESPECIFICACIONES TÉCNICAS / TECHNICAL SPECIFICATION / DÉTAILS TECHNIQUES

Tipo / Type / Type	Hidráulico / Hydraulic / Hydraulique
Presión de trabajo / Working pressure / Pression de travail	140 bar
RPM	380-900-1800
Potencia / Power / Puissance	2,8 kW
Par / Torque / Paire	60/38/17 Nm
Caudal hidráulico / Oil flow / Flux d'huile	22-45 l/min
Conexión / Connection / Connexion	1/2"FF
Brocas standard / Standard drills / Mèche standard	≤160 mm
Longitud / Length / Longueur	490 mm
Designación ATEX / ATEX marking / Marquage ATEX	Ⓜ II 2 G c T5
Peso / Weight / Poids	8,5 kg



\* G12: GARANTÍA 12 MESES / 12 MONTHS OF WARRANTY / 12 MOIS DE GARANTIE / 12 MONATEN GARANTIE / 12 MAANDEN GARANTIE / 12 MESI DI GARANZIA / 12 МЕСЯЦЕВ ГАРАНТИЯ

■ CORTATUBOS BISELADOR / CUTTING AND BEVELLING MACHINE / COUPE-TUBES CHANFREINEUR / ANFAS-MASCHINE / TAGLIATUBI  
SMUSSATORE / CORTA-TUBOS BISELADOR / РЕЗАК-ФАСКОШИМАТЕЛЬ

El cortatubos biselador MasterEX 79760, es una potente máquina hidráulica ideal para cortar y achaflanar tubos de los más diversos materiales como acero, fundición dúctil, hormigón plástico (OE, PVC, GRP)... Especialmente diseñado para trabajos en zonas con ambiente explosivo.

*The MasterEX 79760 is a powerful hydraulic pipe cutting machine ideal for cutting and bevelling of most different materials, as steel, ductile iron, concrete, cement, clay, plastics (PE, PVC, GRP)... Machine especially designed for safety works in explosive areas.*

Le coupe-tube biseauté MasterEX 79760 est une puissante machine hydraulique idéale pour couper et chanfreiner des tubes des matériaux les plus divers tels que l'acier, la fonte ductile, le béton plastique (OE, PVC, GRP) ... Spécialement conçu pour des travaux dans des zones à atmosphère explosive.

■ HIDRÁULICA / HIDRAULIC / HYDRAULIQUE / HYDRAULISCH / IDRAULICA / HIDRÁULICA / ГИДРАВЛИЧЕСКИЙ



\* G12

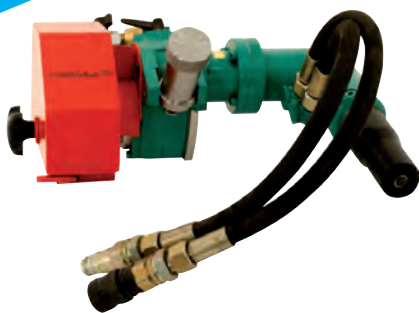

COD.

79760



Zonas / Zones

1, 2 GAS / GAZ

CARACTERÍSTICAS / FEATURES / CARACTÉRISTIQUES

Accesorios no incluidos / Accessories not included / Accessoires non inclus

ESPECIFICACIONES TÉCNICAS / TECHNICAL SPECIFICATION / DÉTAILS TECHNIQUES

Tipo / Type / Type	Hidráulico / Hydraulic / Hydraulique
Presión de trabajo / Working pressure / Pression de travail	90-140 bar
RPM	Etapa 1: 950 / Etapa 2: 200 Stage 1: 950 / Stage 2: 200 Étape 1: 950 / Étape 2: 200
Potencia / Power / Puissance	2 kW
Caudal hidráulico / Oil flow / Flux d'huile	15-50 l/min
Conexión / Connection / Connexion	Flat face 1/2" BSP
Nivel de vibración / Vibration level / Niveau de vibration	< 2,5 m/s <sup>2</sup>
Nivel sonoro / Sound level / Niveau sonore	98,0 db
Brocas standard / Standard drills / Mèche standard	≤160 mm
Altura / Overall length / Longueur	250 mm
Designación ATEX / ATEX marking / Marquage ATEX	⊕ II 2 G c T6
Peso / Weight / Poids	13,0 kg
Para cortar y biselar / To cut and bevel / Pour couper et biseauter	"Acero, INOX, fundición dúctil, metal no férreo, hormigón, cemento, arcilla, plástico, PE, PVC, GFK" / "Steel, INOX, ductile cast iron, non-ferrous metal, concrete, cement, clay, plastic, PE, PVC, GFK" / "Acier, INOX, fonte ductile, métal non ferreux, béton, ciment, argile, plastique, PE, PVC, GFK"
Accesorios incluidos / Accessories included / Accessoires inclus	Mango (79763) / Handle (79763) Manche (79763)

EGA Master  
ART IN INNOVATION

■ **CORTATUBOS BISELADOR / CUTTING AND BEVELLING MACHINE / COUPE-TUBES CHANFREINEUR / ANFAS-MASCHINE / TAGLIATUBI  
SMUSSATORE / CORTA-TUBOS BISELADOR / РЕЗАК-ФАСКОШИМАТЕЛЬ**

■ **ACCESORIOS / ACCESSORIES / ACCESSOIRES / ERSATZTEILE / ACCESSORI / ACESSORIOS / ЗАПАСНЫЕ ЧАСТИ**

■ **CARROS GUÍA / GUIDE-CARRIAGES / CHARIOTS DE GUIDAGE / FÜHRUNGSWAGEN / CARRELLI GUIDA / CARROS-GUÍA / НАПРАВЛЯЮЩИЕ КАРЕТКИ**

COD.	Descripción / Description / Description
79761	Carro guía pequeño / Guide-carriage small / Chariot petit guidage
79762	Carro guía grande / Guide-carriage large / Chariot grand guidage
79763	Mango / Feeding pipe / Manche

■ **CADENA DE GUIADO / GUIDE CHAIN / CHAÎNES DE GUIDAGE / FÜHRUNGSKETTE / CATENE DI GUIDA / CORRENTES DE GUÍA / НАПРАВЛЯЮЩАЯ ЦЕПИ**

COD.	Descripción / Description / Description
79764	Cadena de guiado con 24 eslabones y tensionador / 24 guide chain links and tensioner / Chaîne de guidage à 24 maillons et tenseurs
79765	Cadena de guiado con 35 eslabones y tensionador / 35 guide chain links and tensioner / Chaîne de guidage à 35 maillons et tenseurs
79766	Cadena de guiado con 46 eslabones y tensionador / 46 guide chain links and tensioner / Chaîne de guidage à 46 maillons et tenseurs
79767	Cadena de guiado con 57 eslabones y tensionador / 57 guide chain links and tensioner / Chaîne de guidage à 57 maillons et tenseurs
79768	Cadena de guiado con 68 eslabones y tensionador / 68 guide chain links and tensioner / Chaîne de guidage à 68 maillons et tenseurs
79769	Cadena de guiado con 79 eslabones y tensionador / 79 guide chain links and tensioner / Chaîne de guidage à 79 maillons et tenseurs
79770	Cadena de guiado con 90 eslabones y tensionador / 90 guide chain links and tensioner / Chaîne de guidage à 90 maillons et tenseurs
79772	Eslabón 57 mm / Chain link 57 mm / Maillon 57mm

■ **CADENA DE FIJACIÓN / TENSIONING CHAIN / CHAÎNE DE FIXATION / SPANNKETTE / CATENA DI FISSAZIONE / CORRENT DE FIXAÇÃO / КРЕПЁЖНАЯ ЦЕПЬ**

COD.	Descripción / Description / Description
79773	Tensionador pequeño / Tensioner small / Tenseur petit
79774	Tensionador grande / Tensioner large / Tenseur grand
79775	Cadena de fijación / Tensioning chain / Chaîne de fixation

■ **CONSUMIBLES DE CORTE / CUTTING SUPPLIES / CONSOMMABLES DE COUPE / SCHNEIDWAREN / CONSUMABILI DI TAGLIO / CONSUMÍVEIS DE CORTE /  
РАСХОДНЫЕ МАТЕРИАЛЫ ДЛЯ РЕЗКИ**

COD.	Descripción / Description / Description	MAT.	Ø (mm)
79776	Disco con dientes de carburo / Carbide-tipped blade / Disque avec dents en carbure	Carburo / Carbide / Carbure	180
79777	Disco de diamante / Diamond-tipped blade / Disque de diamant	Diamante / Diamond / Diamant	180
79778	Disco biselador 45° / Beveling cutter 45° / Disque biseau 45°		
79779	Disco biselador 60° / Beveling cutter 60° / Disque biseau 60°	HSS	100
79780	Disco biselador 90° / Beveling cutter 90° / Disque biseau 90°		



\* **G12:** GARANTÍA 12 MESES / 12 MONTHS OF WARRANTY / 12 MOIS DE GARANTIE / 12 MONATEN GARANTIE / 12 MAANDEN GARANTIE / 12 MESI DI GARANZIA / 12 МЕСЯЦЕВ ГАРАНТИЯ

**LLAVE DINAMOMÉTRICA / TORQUE WRENCH / CLÉ DYNAMOMÉTRIQUE / DREHMOMENT-SCHRAUBENSCHLÜSSEL / CHIAVE DINAMOMETRICA / CHAVE DINAMOMÉTRICA / ДИНАМОМЕТРИЧЕСКИЕ КЛЮЧИ**

Las llaves dinamo métricas ATEX de **EGA Master** también llamadas llaves de torsión, son herramientas que se utilizan para ajustar el par de apriete de elementos roscados. Disponen de un mecanismo, que hace que una vez alcanzado el par deseado, la llave no trasmite más par al elemento que estamos apretando.

*The EGA Master ATEX torque wrenches are used to adjust the torque of threaded elements. They have a mechanism which avoids transferring extra torque after reaching the desired torque value.*

Les clés dynamométriques ATEX d'**EGA Master**, également appelées clés de torsion, sont des outils qui s'utilisent pour ajuster le couple de serrage d'éléments filetés. Elles sont dotées d'un système automatique de désenclenchement de serrage une fois atteint le couple sélectionné.

**■ NEUMÁTICO / PNEUMATIC / PNEUMATIQUE / PNEUMATIK / PNEUMATICA / PNEUMÁTICO / ПНЕВМАТИЧЕСКИЕ**

\* G12

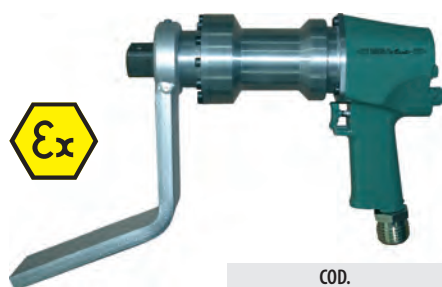

COD.

**79607**

**Zonas / Zones**

**M2 MINERÍA / MINING / MINIERE**

**CARACTERÍSTICAS / FEATURES / CARACTÉRISTIQUES**

Accesorios no incluidos / Accessories not included / Accessoires non inclus

**ESPECIFICACIONES TÉCNICAS / TECHNICAL SPECIFICATION / DÉTAILS TECHNIQUES**

Tipo / Type / Type	Neumático / Pneumatic / Pneumatique
Presión de trabajo / Working pressure / Pression de travail	4/6 bar
Cuadrado conductor / Square drive / Carré conducteur	1"
Precisión / Accuracy / Précision	±5-10%
Par de apriete / Torque / Paire de serrage	4 bar: 650 Nm / 6 bar: 750 Nm
Consumo de aire / Air consumption / Consommation d'air	4 bar: 0,55 m³/min / 6 bar: 0,75 m³/min
Para pernos y tuercas / For bolts and nuts / Pour boulons et écrous	≤ M30 (46 mm AF)
Reversible / Reversible / Réversible	●
Conexión / Connection / Connexion	Rd 32 x 1/8"
Manguera (Øint.) / Hose (Øint.) / Tuyau (Øint.)	10 mm
Nivel sonoro / Sound level / Niveau sonore	86,4 db
Nivel de vibración / Vibration level / Niveau de vibration	<2,5 m/s²
Designación ATEX / ATEX marking / Marquage ATEX	Ⓜ I M 2 c T6
Peso / Weight / Poids	7,8 kg

\* G12



COD.

**79608**

**Zonas / Zones**

**M2 MINERÍA / MINING / MINIERE**

**CARACTERÍSTICAS / FEATURES / CARACTÉRISTIQUES**

Accesorios no incluidos / Accessories not included / Accessoires non inclus

**ESPECIFICACIONES TÉCNICAS / TECHNICAL SPECIFICATION / DÉTAILS TECHNIQUES**

Tipo / Type / Type	Neumático / Pneumatic / Pneumatique
Presión de trabajo / Working pressure / Pression de travail	4/6 bar
Cuadrado conductor / Square drive / Carré conducteur	1"
Precisión / Accuracy / Précision	±5-10%
Par de apriete / Torque / Paire de serrage	4 bar: 1500 Nm / 6 bar: 1800 Nm
Consumo de aire / Air consumption / Consommation d'air	4 bar: 0,55 m³/min / 6 bar: 0,65 m³/min
Para pernos y tuercas / For bolts and nuts / Pour boulons et écrous	≤ M30 (46 mm AF)
Reversible / Reversible / Réversible	●
Conexión / Connection / Connexion	Rd 32 x 1/8"
Manguera (Øint.) / Hose (Øint.) / Tuyau (Øint.)	10 mm
Nivel sonoro / Sound level / Niveau sonore	86,4 db
Nivel de vibración / Vibration level / Niveau de vibration	<2,5 m/s²
Designación ATEX / ATEX marking / Marquage ATEX	Ⓜ I M 2 c T6
Peso / Weight / Poids	8,6 kg



Vasos de impacto antichispa - Cuadrado 1/2", 3/4", 1" y 1.1/2" - Ver capítulo de Antichispa.  
 Non-sparking impact socket wrenches - 1/2", 3/4", 1" and 1.1/2" Sq. Drive - See Non-sparking chapter.  
 Douilles à choc anti-déflagrant - Carrée de 1/2", 3/4", 1" et 1.1/2" - Voir chapitre Anti-déflagrant.

LLAVE DINAMOMÉTRICA / TORQUE WRENCH / CLÉ DYNAMOMÉTRIQUE / DREHMOMENT-SCHRAUBENSCHLÜSSEL / CHIAVE DINAMOMETRICA / CHAVE DINAMOMÉTRICA / ДИНАМОМЕТРИЧЕСКИЕ КЛЮЧИ

■ NEUMÁTICO / PNEUMATIC / PNEUMATIQUE / PNEUMATIK / PNEUMATICA / PNEUMÁTICO / ПНЕВМАТИЧЕСКИЕ

\* G12 CE



COD.

79609



Zonas / Zones

M2 MINERÍA / MINING / MINIÈRE

CARACTERÍSTICAS / FEATURES / CARACTÉRISTIQUES

Accesorios no incluidos / Accessories not included / Accessoires non inclus

ESPECIFICACIONES TÉCNICAS / TECHNICAL SPECIFICATION / DÉTAILS TECHNIQUES

Tipo / Type / Type	Neumático / Pneumatic / Pneumatique
Presión de trabajo / Working pressure / Pression de travail	4/6 bar
Cuadrado conductor / Square drive / Carré conducteur	1.1/2"
Precisión / Accuracy / Précision	±5-10%
Par de apriete / Torque / Paire de serrage	4 bar: 2800 Nm / 6 bar: 3600 Nm
Consumo de aire / Air consumption / Consommation d'air	4 bar: 1,30 m <sup>3</sup> /min / 6 bar: 1,70 m <sup>3</sup> /min
Para pernos y tuercas / For bolts and nuts / Pour boulons et écrous	≤ M48 (75 mm AF)
Reversible / Reversible / Réversible	●
Conexión / Connection / Connexion	Rd 32 x 1/8"
Manguera (Øint.) / Hose (Øint.) / Tuyau (Øint.)	10 mm
Nivel sonoro / Sound level / Niveau sonore	93 db
Nivel de vibración / Vibration level / Niveau de vibration	<2,5 m/s <sup>2</sup>
Designación ATEX / ATEX marking / Marquage ATEX	Ⓜ I M 2 c T6
Peso / Weight / Poids	14,9 kg



Vasos de impacto antichispa - Cuadrado 1/2", 3/4", 1" y 1.1/2" - Ver capítulo de Antichispa.  
Non-sparking impact socket wrenches - 1/2", 3/4", 1" and 1.1/2" Sq. Drive - See Non-sparking chapter.  
Douilles à choc anti-déflagrant - Carrée de 1/2", 3/4", 1" et 1.1/2" - Voir chapitre Anti-déflagrant.

\* G12: GARANTÍA 12 MESES / 12 MONTHS OF WARRANTY / 12 MOIS DE GARANTIE / 12 MONATEN GARANTIE / 12 MAANDEN GARANTIE / 12 MESI DI GARANZIA / 12 МЕСЯЦЕВ ГАРАНТИЯ



■ LLAVES DE IMPACTO / IMPACT WRENCHES / CLÉS À CHOC / SCHLAGSCHRAUBER / AVVITATORI AD IMPULSI / CHAVES DE IMPACTO / УДАРНЫЕ ГАЙКОВЕРТЫ

Las llaves de impacto se utilizan para aplicar altos pares a tornillos de todo tipo con el simple accionamiento de un gatillo. De esta manera, podremos apretar y aflojar tornillos (por muy oxidados que éstos estén) que a mano nos sería imposible. Es muy importante tener en cuenta la medida de los tornillos con los que se va a trabajar porque no todos aguantaran el par máximo que estas llaves son capaces de aplicar.

Impact wrenches are used to apply high torque to nuts of all kinds. Thus, we can tighten and loosen the nuts (even very oxidized ones) that would be impossible to do by hand. It is very important to consider which nuts we will work on, because not all of them will stand the maximum torque that these wrenches are able to apply.

Les clés à choc s'utilisent pour un serrage important de boulons, en actionnant tout simplement une gachette. De cette façon il est possible de serrer ou de desserrer des écrous oxydés. Il est important de prendre en compte le diamètre d'écrou à travailler.

■ NEUMÁTICO / PNEUMATIC / PNEUMATIQUE / PNEUMATIK / PNEUMATICA / PNEUMÁTICO / ПНЕВМАТИЧЕСКИЕ

\* G12



COD.

79610

Zonas / Zones

M2 MINERÍA / MINING / MINIERE

CARACTERÍSTICAS / FEATURES / CARACTÉRISTIQUES

Accesorios no incluidos / Accessories not included / Accessoires non inclus

ESPECIFICACIONES TÉCNICAS / TECHNICAL SPECIFICATION / DÉTAILS TECHNIQUES

Tipo / Type / Type	Neumático / Pneumatic / Pneumatique
Presión de trabajo / Working pressure / Pression de travail	6 bar
Cuadrado conductor / Square drive / Carré conducteur	1/2"
Par de apriete / Torque / Paire de serrage	610 Nm
Consumo de aire / Air consumption / Consommation d'air	0,32 m³/min
Para pernos y tuercas / For bolts and nuts / Pour boulons et écrous	≤ M20 (30 mm AF)
Conexión / Connection / Connexion	R 1/4"f
Manguera (Øint.) / Hose (Øint.) / Tuyau (Øint.)	10 mm
Nivel sonoro / Sound level / Niveau sonore	90 db
Nivel de vibración / Vibration level / Niveau de vibration	<2,6 m/s²
Longitud / Length / Longueur	160 mm
Designación ATEX / ATEX marking / Marquage ATEX	Ⓢ I M 2 c T6
Peso / Weight / Poids	3,6 kg

\* G12



COD.

79626

79612

Zonas / Zones

1, 2 GAS / GAZ

CARACTERÍSTICAS / FEATURES / CARACTÉRISTIQUES

Accesorios no incluidos / Accessories not included / Accessoires non inclus

ESPECIFICACIONES TÉCNICAS / TECHNICAL SPECIFICATION / DÉTAILS TECHNIQUES

Tipo / Type / Type	Neumático / Pneumatic / Pneumatique
Presión de trabajo / Working pressure / Pression de travail	6 bar
Cuadrado conductor / Square drive / Carré conducteur	79626 3/4" 79612 1"
Par de apriete / Torque / Paire de serrage	1350 Nm
Consumo de aire / Air consumption / Consommation d'air	1,40 m³/min
Para pernos y tuercas / For bolts and nuts / Pour boulons et écrous	≤ M30 (46 mm AF)
Conexión / Connection / Connexion	79626 R 1/4"f 79612 R 1/2"i
Manguera (Øint.) / Hose (Øint.) / Tuyau (Øint.)	13 mm
Nivel sonoro / Sound level / Niveau sonore	96 db
Nivel de vibración / Vibration level / Niveau de vibration	4,5 m/s²
Longitud / Length / Longueur	79626 220 mm 79612 228 mm
Designación ATEX / ATEX marking / Marquage ATEX	Ⓢ II 2 G c T6
Peso / Weight / Poids	79626 5,6 kg 79612 5,7 kg



Vasos de impacto antichispa - Cuadrado 1/2", 3/4", 1" y 1.1/2" - Ver capítulo de Antichispa.

Non-sparking impact socket wrenches - 1/2", 3/4", 1" and 1.1/2" Sq. Drive - See Non-sparking chapter.

Douilles à choc anti-déflagrant - Carrée de 1/2", 3/4", 1" et 1.1/2" - Voir chapitre Anti-déflagrant.

■ LLAVES DE IMPACTO / IMPACT WRENCHES / CLÉS À CHOC / SCHLAGSCHRAUBER / AVVITATORI AD IMPULSI / CHAVES DE IMPACTO / УДАРНЫЕ ГАЙКОВЕРТЫ

■ NEUMÁTICO / PNEUMATIC / PNEUMATIQUE / PNEUMATIK / PNEUMATICA / PNEUMÁTICO / ПНЕВМАТИЧЕСКИЕ

\* G12 CE



Zonas / Zones

1, 2 GAS / GAZ

CARACTERÍSTICAS / FEATURES / CARACTÉRISTIQUES

Accesorios no incluidos / Accessories not included / Accessoires non inclus

ESPECIFICACIONES TÉCNICAS / TECHNICAL SPECIFICATION / DÉTAILS TECHNIQUES

Tipo / Type / Type	Neumático / Pneumatic / Pneumatique
Presión de trabajo / Working pressure / Pression de travail	6 bar
Cuadrado conductor / Square drive / Carré conducteur	
	79902 3/4"
	79903 1"
Par máx. / Torque max. / Paire max.	1350 Nm
Consumo de aire / Air consumption / Consommation d'air	1,4 m <sup>3</sup> /min
Para pernos y tuercas / For bolts and nuts / Pour boulons et écrous	≤ M30 (46 mm AF)
Conexión (entrada/salida) / Connection (inlet/outlet) / Connexion (entrée/sortie)	R 1/2" f - R 1/2" f
Manguera (Øint.) / Hose (Øint.) / Tuyau (Øint.)	13 mm
Nivel sonoro / Sound level / Niveau sonore	96 db
Nivel de vibración / Vibration level / Niveau de vibration	
	79902 6,2 m/s <sup>2</sup>
	79903 4,5 m/s <sup>2</sup>
Designación ATEX / ATEX marking / Marquage ATEX	⊕ II 2 G c T6
Peso / Weight / Poids	
	79902 5,6 kg
	79903 5,5 kg

EGGA Master  
ART IN INNOVATION



Vasos de impacto antichispa - Cuadrado 1/2", 3/4", 1" y 1.1/2" - Ver capítulo de Antichispa.  
Non-sparking impact socket wrenches - 1/2", 3/4", 1" and 1.1/2" Sq. Drive - See Non-sparking chapter.  
Douilles à choc anti-déflagrant - Carrée de 1/2", 3/4", 1" et 1.1/2" - Voir chapitre Anti-déflagrant.

\* G12: GARANTÍA 12 MESES / 12 MONTHS OF WARRANTY / 12 MOIS DE GARANTIE / 12 MONATEN GARANTIE / 12 MAANDEN GARANTIE / 12 MESI DI GARANZIA / 12 МЕСЯЦЕВ ГАРАНТИЯ

■ LLAVES DE IMPACTO / IMPACT WRENCHES / CLÉS À CHOC / SCHLAGSCHRAUBER / AVVITATORI AD IMPULSI / CHAVES DE IMPACTO / УДАРНЫЕ ГАЙКОВЕРТЫ

■ NEUMÁTICO / PNEUMATIC / PNEUMATIQUE / PNEUMATIK / PNEUMATICA / PNEUMÁTICO / ПНЕВМАТИЧЕСКИЕ

\* G12 CE



COD.  
79613



Zonas / Zones

M2 MINERÍA / MINING / MINIÈRE

CARACTERÍSTICAS / FEATURES / CARACTÉRISTIQUES

Accesorios no incluidos / Accessories not included / Accessoires non inclus

ESPECIFICACIONES TÉCNICAS / TECHNICAL SPECIFICATION / DÉTAILS TECHNIQUES

Tipo / Type / Type	Neumático / Pneumatic / Pneumatique
Presión de trabajo / Working pressure / Pression de travail	6 bar
Cuadrado conductor / Square drive / Carré conducteur	1"
Par de apriete / Torque / Paire de serrage	1800 Nm
Consumo de aire / Air consumption / Consommation d'air	1,10 m <sup>3</sup> /min
Para pernos y tuercas / For bolts and nuts / Pour boulons et écrous	≤ M33 (50 mm AF)
Conexión / Connection / Connexion	Rd 32 x 1/8"a
Manguera (Øint.) / Hose (Øint.) / Tuyau (Øint.)	13 mm
Nivel sonoro / Sound level / Niveau sonore	92 db
Nivel de vibración / Vibration level / Niveau de vibration	3,2 m/s <sup>2</sup>
Longitud / Length / Longueur	280 mm
Designación ATEX / ATEX marking / Marquage ATEX	Ⓢ I M 2 c T6
Peso / Weight / Poids	9 kg

\* G12 CE



COD.  
79631



Zonas / Zones

1, 2 GAS / GAZ

CARACTERÍSTICAS / FEATURES / CARACTÉRISTIQUES

Accesorios no incluidos / Accessories not included / Accessoires non inclus

ESPECIFICACIONES TÉCNICAS / TECHNICAL SPECIFICATION / DÉTAILS TECHNIQUES

Tipo / Type / Type	Neumático / Pneumatic / Pneumatique
Presión de trabajo / Working pressure / Pression de travail	6 bar
Cuadrado conductor / Square drive / Carré conducteur	1.1/2"
Par de apriete / Torque / Paire de serrage	4400 Nm
Consumo de aire / Air consumption / Consommation d'air	1,6 m <sup>3</sup> /min
Para pernos y tuercas / For bolts and nuts / Pour boulons et écrous	≤ M56 (85 mm AF)
Conexión / Connection / Connexion	R 1/2"i
Manguera (Øint.) / Hose (Øint.) / Tuyau (Øint.)	15 mm
Nivel sonoro / Sound level / Niveau sonore	107 db
Nivel de vibración / Vibration level / Niveau de vibration	<6,6 m/s <sup>2</sup>
Designación ATEX / ATEX marking / Marquage ATEX	Ⓢ II 2 G c T6
Peso / Weight / Poids	12,2 kg



Vasos de impacto antichispa - Cuadrado 1/2", 3/4", 1" y 1.1/2" - Ver capítulo de Antichispa.  
Non-sparking impact socket wrenches - 1/2", 3/4", 1" and 1.1/2" Sq. Drive - See Non-sparking chapter.  
Douilles à choc anti-déflagrant - Carrée de 1/2", 3/4", 1" et 1.1/2" - Voir chapitre Anti-déflagrant.

■ LLAVES DE IMPACTO / IMPACT WRENCHES / CLÉS À CHOC / SCHLAGSCHRAUBER / AVVITATORI AD IMPULSI / CHAVES DE IMPACTO / УДАРНЫЕ ГАЙКОВЕРТЫ

■ HIDRÁULICA / HIDRAULIC / HYDRAULIQUE / HYDRAULISCH / IDRAULICA / HIDRÁULICA / ГИДРАВЛИЧЕСКИЙ

\* G12 CE



COD.

79662

Zonas / Zones

1, 2 GAS / GAZ

CARACTERÍSTICAS / FEATURES / CARACTÉRISTIQUES

Accesorios no incluidos / Accessories not included / Accessoires non inclus

ESPECIFICACIONES TÉCNICAS / TECHNICAL SPECIFICATION / DÉTAILS TECHNIQUES

Tipo / Type / Type	Hidráulico / Hydraulic / Hydraulique
Presión de trabajo / Working pressure / Pression de travail	70-140 bar
Cuadrado conductor / Square drive / Carré conducteur	3/4"
Par máx. / Torque max. / Paire max.	1700 Nm
Para pernos y tuercas / For bolts and nuts / Pour boulons et écrous	≤ M30 (46 mm AF)
Caudal hidráulico / Oil flow / Flux d'huile	20-40 l/min
Conexión / Connection / Connexion	M18 x 1,5
Manguera (Øint.) / Hose (Øint.) / Tuyau (Øint.)	12 mm
Nivel sonoro / Sound level / Niveau sonore	85,3 db
Nivel de vibración / Vibration level / Niveau de vibration	3,8 m/s <sup>2</sup>
Longitud / Length / Longueur	245 mm
Designación ATEX / ATEX marking / Marquage ATEX	Ⓜ I M 2 c T5
Peso / Weight / Poids	9 kg

\* G12 CE



COD.

79917

79918

Zonas / Zones

1, 2 GAS / GAZ

CARACTERÍSTICAS / FEATURES / CARACTÉRISTIQUES

Accesorios no incluidos / Accessories not included / Accessoires non inclus

ESPECIFICACIONES TÉCNICAS / TECHNICAL SPECIFICATION / DÉTAILS TECHNIQUES

Tipo / Type / Type	Hidráulico / Hydraulic / Hydraulique
Presión de trabajo / Working pressure / Pression de travail	70-140 bar
Cuadrado conductor / Square drive / Carré conducteur	79917 3/4" 79918 1"
Par máx. / Torque max. / Paire max.	1700 Nm
Para pernos y tuercas / For bolts and nuts / Pour boulons et écrous	≤ M30 (46 mm AF)
Caudal hidráulico / Oil flow / Flux d'huile	20-40 l/min
Conexión / Connection / Connexion	M18 x 1,5
Manguera (Øint.) / Hose (Øint.) / Tuyau (Øint.)	12 mm
Nivel sonoro / Sound level / Niveau sonore	85,3 db
Nivel de vibración / Vibration level / Niveau de vibration	3,8 m/s <sup>2</sup>
Longitud / Length / Longueur	245 mm
Designación ATEX / ATEX marking / Marquage ATEX	Ⓜ II 2 G c T5
Peso / Weight / Poids	7,3 kg



Vasos de impacto antichispa - Cuadrado 1/2", 3/4", 1" y 1.1/2" - Ver capítulo de Antichispa.  
Non-sparking impact socket wrenches - 1/2", 3/4", 1" and 1.1/2" Sq. Drive - See Non-sparking chapter.  
Douilles à choc anti-déflagrant - Carrée de 1/2", 3/4", 1" et 1.1/2" - Voir chapitre Anti-déflagrant.

\* G12: GARANTÍA 12 MESES / 12 MONTHS OF WARRANTY / 12 MOIS DE GARANTIE / 12 MONATEN GARANTIE / 12 MAANDEN GARANTIE / 12 MESI DI GARANZIA / 12 МЕСЯЦЕВ ГАРАНТИЯ

■ LLAVES DE IMPACTO / IMPACT WRENCHES / CLÉS À CHOC / SCHLAGSCHRAUBER / AVVITATORI AD IMPULSI / CHAVES DE IMPACTO / УДАРНЫЕ ГАЙКОВЕРТЫ

■ HIDRÁULICA / HIDRAULIC / HYDRAULIQUE / HYDRAULISCH / IDRAULICA / HIDRÁULICA / ГИДРАВЛИЧЕСКИЙ

\* G12 CE



COD.

79919



Zonas / Zones

1, 2 GAS / GAZ

CARACTERÍSTICAS / FEATURES / CARACTÉRISTIQUES

Accesorios no incluidos / Accessories not included / Accessoires non inclus

ESPECIFICACIONES TÉCNICAS / TECHNICAL SPECIFICATION / DÉTAILS TECHNIQUES

Tipo / Type / Type	Hidráulico / Hydraulic / Hydraulique
Presión de trabajo / Working pressure / Pression de travail	140 bar
Cuadrado conductor / Square drive / Carré conducteur	1"
Par / Torque / Paire	2500 Nm
Para pernos y tuercas / For bolts and nuts / Pour boulons et écrous	≤ M36 (55 mm AF)
Caudal hidráulico / Oil flow / Flux d'huile	25-45 l/min
Conexión / Connection / Connexion	1/2"FF
Designación ATEX / ATEX marking / Marquage ATEX	Ⓜ II 2 G c T5
Peso / Weight / Poids	10,7 kg

EGGA Master  
ART IN INNOVATION



Vasos de impacto antichispa - Cuadrado 1/2", 3/4", 1" y 1.1/2" - Ver capítulo de Antichispa.  
Non-sparking impact socket wrenches - 1/2", 3/4", 1" and 1.1/2" Sq. Drive - See Non-sparking chapter.  
Douilles à choc anti-déflagrant - Carrée de 1/2", 3/4", 1" et 1.1/2" - Voir chapitre Anti-déflagrant.

■ BOMBAS / POWER UNIT PUMP / POMPES / PUMPE / POMPE / BOMBAS / НАСОС

La bomba hidráulica ATEX EGA Master 79785 no solo aporta las mejores prestaciones en cuanto a presión y caudal para un trabajo rápido y ergonómico, sino que asegura el cumplimiento de las medidas de seguridad exigidas por la Directiva 2014/34/UE para ambientes explosivos.

*The EGA Master ATEX hydraulic power unit pump 79785, not only provides the best features in terms of pressure and flow for a quick and ergonomic work, but also ensures the fulfilment of the safety measures required by 2014/34/UE Directive for explosive environments.*

La pompe hydraulique ATEX EGA Master 79785 non seulement proportionne les meilleures performances en termes de pression et de débit pour un travail rapide et ergonomique, mais elle assure également l'accomplissement des mesures de sécurité requises par la directive 2014/34/UE pour les environnements explosifs.

■ HIDRÁULICA / HIDRAULIC / HYDRAULIQUE / HYDRAULISCH / IDRAULICA / HIDRÁULICA / ГИДРАВЛИЧЕСКИЙ

\* G12



COD.

79785

Zonas / Zones

1, 2 GAS / GAZ

CARACTERÍSTICAS / FEATURES / CARACTÉRISTIQUES

Accesorios no incluidos / Accessories not included / Accessoires non inclus

ESPECIFICACIONES TÉCNICAS / TECHNICAL SPECIFICATION / DÉTAILS TECHNIQUES

Tipo / Type / Type	Hidráulico / Hydraulic / Hydraulique
Voltaje / Voltage / Voltage	400 V
Potencia / Power / Puissance	1,1 kW
Capacidad / Capacity / Capacité	10 L
Caudal / Flow rate / Débit	7,5 l/min. @ 75 bar / 0,9 l/min @ 700 bar
Designación ATEX / ATEX marking / Marquage ATEX	⊕ II 2 G KT3
Puertos / Ports / Ports	4



\* G12: GARANTÍA 12 MESES / 12 MONTHS OF WARRANTY / 12 MOIS DE GARANTIE / 12 MONATEN GARANTIE / 12 MAANDEN GARANTIE / 12 MESI DI GARANZIA / 12 МЕСЯЦЕВ ГАРАНТИЯ

■ SIERRAS / SAWS / SCIES / SÄGEN / SEGNETTO / SERRAS / ПИЛЫ

Las sierras de cinta o de banda de **EGA Master**, tiene una hoja metálica dentada, larga, estrecha y flexible que se desplaza sobre dos ruedas que se encuentran en el mismo plano vertical. Sus aplicaciones son muy variadas: construcción, corte de tuberías, refineries... y son capaces de cortar: plástico, madera, acero, INOX...

Las sierras portátiles son herramientas necesarias para poder realizar todo tipo de cortes; cortes cruzados, rectos, cortes curvos, cortes en pico, biselados, etc...

*EGA Master band saw has a long, narrow and flexible toothed metal saw blade that moves on two wheels which are in the same vertical plane. Its applications are varied: construction, pipe cutting, refineries... Besides, they are capable of cutting: plastic, wood, steel, stainless steel...*

*Portable saws are necessary to perform all type of cutting, cross, straight, curved, cuts in peak, beveled, etc...*

Les scies à ruban ou à bande d'**EGA Master**, a une bande métallique dentée, étroite et flexible qui se déplace sur deux roues se trouvant au même niveau verticalement. Ses applications sont diverses: construction, coupure de tuyauterie et raffinerie... et sont capables de couper du plastique, du bois, de l'acier, de l'INOX...

Les scies portables sont des outils nécessaires afin de réaliser tous types de coupures : croisées, droites, courbées, en pic, biseauté, etc...

■ NEUMÁTICO / PNEUMATIC / PNEUMATIQUE / PNEUMATIK / PNEUMATICA / PNEUMÁTICO / ПНЕВМАТИЧЕСКИЕ

■ SIERRA DE BANDA / BAND SAW / SCIE À RUBAN / BANDSÄGE / SEGA DI NASTRO / SERRA DE FITA / ЛЕНТОЧНАЯ ПИЛА

\* G12



COD.

79615



Zonas / Zones

1, 2 GAS / GAZ

CARACTERÍSTICAS / FEATURES / CARACTÉRISTIQUES

Accesorios no incluidos / Accessories not included / Accessoires non inclus

ESPECIFICACIONES TÉCNICAS / TECHNICAL SPECIFICATION / DÉTAILS TECHNIQUES

Tipo / Type / Type	Neumático / Pneumatic / Pneumatique
Presión de trabajo / Working pressure / Pression de travail	6 bar
Capacidad de corte / Cutting capacity / Capacité de coupe	Ø 120 mm / 150 x 120 mm / 4 x 4"
Velocidad / Speed / Vitesse	4 bar: 41 m/min / 6 bar: 61 m/min
Potencia / Power / Puissance	0,5 kW
Consumo de aire / Air consumption / Consommation d'air	0,55 m³/min
Conexión / Connection / Connexion	R 1/4"i
Manguera (Øint.) / Hose (Øint.) / Tuyau (Øint.)	7 mm
Nivel sonoro / Sound level / Niveau sonore	86,8 db
Nivel de vibración / Vibration level / Niveau de vibration	<2,5 m/s²
Material de la carcasa / Casing material / Matière de la coque	Aluminio / Aluminum / Aluminium
Designación ATEX / ATEX marking / Marquage ATEX	Ⓜ II 2 G c T6
L x W x H	516 x 170 x 210 mm
Peso / Weight / Poids	6,2 kg

\* G12



COD.

79616



Zonas / Zones

M2 MINERÍA / MINING / MINIÈRE

CARACTERÍSTICAS / FEATURES / CARACTÉRISTIQUES

Accesorios no incluidos / Accessories not included / Accessoires non inclus

ESPECIFICACIONES TÉCNICAS / TECHNICAL SPECIFICATION / DÉTAILS TECHNIQUES

Tipo / Type / Type	Neumático / Pneumatic / Pneumatique
Presión de trabajo / Working pressure / Pression de travail	6 bar
Capacidad de corte / Cutting capacity / Capacité de coupe	Ø 180 mm / 180 x 180 mm / 7 x 7"
Potencia / Power / Puissance	1 kW
Consumo de aire / Air consumption / Consommation d'air	1,2 m³/min
Conexión / Connection / Connexion	R 1/2"i
Manguera (Øint.) / Hose (Øint.) / Tuyau (Øint.)	13 mm
Nivel sonoro / Sound level / Niveau sonore	81,7 db
Nivel de vibración / Vibration level / Niveau de vibration	<2,5 m/s²
Material de la carcasa / Casing material / Matière de la coque	Inox / Inox / Inox
Designación ATEX / ATEX marking / Marquage ATEX	Ⓜ I M 2 c T6
L x W x H	730 x 285 x 290 mm
Peso / Weight / Poids	13 kg

■ SIERRAS / SAWS / SCIES / SÄGEN / SEGNETTO / SERRAS / ПИЛЫ

■ NEUMÁTICO / PNEUMATIC / PNEUMATIQUE / PNEUMATIK / PNEUMATICA / PNEUMÁTICO / ПНЕВМАТИЧЕСКИЕ

■ SIERRAS PORTÁTILES / RECIPROCATING SAWS / SCIES PORTABLES / STICHSÄGE / SEGNETTI PORTATILI / SERRAS PORTÁTEIS / ПИЛЫ ВОЗВРАТНО-ПОСТУПАТЕЛЬНОГО ДЕЙСТВИЯ

\* G12



COD.  
79617



Zonas / Zones  
1, 2 GAS / GAZ

CARACTERÍSTICAS / FEATURES / CARACTÉRISTIQUES

Accesorios no incluidos / Accessories not included / Accessoires non inclus

ESPECIFICACIONES TÉCNICAS / TECHNICAL SPECIFICATION / DÉTAILS TECHNIQUES

Tipo / Type / Type	Neumático / Pneumatic / Pneumatique
Presión de trabajo / Working pressure / Pression de travail	6 bar
Tipo de válvula / Valve type / Type de valve	Twist2
N.º de golpes / Number of strokes / Nro. de coups	330 (1/min)
Potencia / Power / Puissance	1,1 kW
Consumo de aire / Air consumption / Consommation d'air	1,45 m³/min
Carrera / Stroke / Parcours	60 mm
Conexión / Connection / Connexion	R 3/4" a
Manguera (Øint.) / Hose (Øint.) / Tuyau (Øint.)	13 mm
Nivel sonoro / Sound level / Niveau sonore	84 db
Nivel de vibración / Vibration level / Niveau de vibration	<2,5 m/s²
Material de la carcasa / Casing material / Matière de la coque	Aluminio / Aluminum / Aluminium
Designación ATEX / ATEX marking / Marquage ATEX	⊕ II 2 G c T5
Peso / Weight / Poids	6,4 kg

\* G12



COD.  
79618



Zonas / Zones  
M2 MINERÍA / MINING / MINIÈRE

CARACTERÍSTICAS / FEATURES / CARACTÉRISTIQUES

Accesorios no incluidos / Accessories not included / Accessoires non inclus

ESPECIFICACIONES TÉCNICAS / TECHNICAL SPECIFICATION / DÉTAILS TECHNIQUES

Tipo / Type / Type	Neumático / Pneumatic / Pneumatique
Presión de trabajo / Working pressure / Pression de travail	6 bar
Tipo de válvula / Valve type / Type de valve	Twist2
N.º de golpes / Number of strokes / Nro. de coups	330 (1/min)
Potencia / Power / Puissance	1,1 kW
Consumo de aire / Air consumption / Consommation d'air	1,45 m³/min
Carrera / Stroke / Parcours	60 mm
Conexión / Connection / Connexion	R 3/4" a
Manguera (Øint.) / Hose (Øint.) / Tuyau (Øint.)	13 mm
Nivel sonoro / Sound level / Niveau sonore	84 db
Nivel de vibración / Vibration level / Niveau de vibration	<2,5 m/s²
Material de la carcasa / Casing material / Matière de la coque	Zamak
Designación ATEX / ATEX marking / Marquage ATEX	⊕ I M 2 c T5
Peso / Weight / Poids	10,6 kg

\* G12: GARANTÍA 12 MESES / 12 MONTHS OF WARRANTY / 12 MOIS DE GARANTIE / 12 MONATEN GARANTIE / 12 MAANDEN GARANTIE / 12 MESI DI GARANZIA / 12 МЕСЯЦЕВ ГАРАНТИЯ



■ SIERRAS / SAWS / SCIES / SÄGEN / SEGNETTO / SERRAS / ПИЛЫ

■ HIDRÁULICA / HIDRAULIC / HYDRAULIQUE / HYDRAULISCH / IDRAULICA / HIDRÁULICA / ГИДРАВЛИЧЕСКИЙ

■ SIERRAS PORTÁTILES / RECIPROCATING SAWS / SCIES PORTABLES / STICHSÄGE / SEGNETTI PORTATILI / SERRAS PORTÁTEIS / ПИЛЫ ВОЗВРАТНО-ПОСТУПАТЕЛЬНОГО ДЕЙСТВИЯ

\* G12 CE



COD.  
79913



Zonas / Zones  
1, 2 GAS / GAZ

CARACTERÍSTICAS / FEATURES / CARACTÉRISTIQUES

Accesorios no incluidos / Accessories not included / Accessoires non inclus

ESPECIFICACIONES TÉCNICAS / TECHNICAL SPECIFICATION / DÉTAILS TECHNIQUES

Tipo / Type / Type	Hidráulico / Hydraulic / Hydraulique
Presión de trabajo / Working pressure / Pression de travail	140 bar
Tipo de válvula / Valve type / Type de valve	Twist
N.º de golpes / Number of strokes / Nro. de coups	500 rpm
Potencia / Power / Puissance	2,8 kW
Caudal hidráulico / Oil flow / Flux d'huile	10-50 l/min
Carrera / Stroke / Parcours	60 mm
Conexión / Connection / Connexion	12S
Manguera (Øint.) / Hose (Øint.) / Tuyau (Øint.)	12 mm
Nivel sonoro / Sound level / Niveau sonore	86 db
Nivel de vibración / Vibration level / Niveau de vibration	<2,5 m/s <sup>2</sup>
Material de la carcasa / Casing material / Matière de la coque	Aluminio / Aluminum / Aluminium
Designación ATEX / ATEX marking / Marquage ATEX	Ⓢ II 2 G c T5
Peso / Weight / Poids	6,1 kg

■ SIERRA SABLE / SABRE SAW / SCIE SABRE / SÄBELSÄGE / SEGNETTO ALTERNATIVO / SERRA DE SABRE / САБЕЛЬНАЯ ПИЛА

\* G12 CE



COD.  
79914



Zonas / Zones  
1, 2 GAS / GAZ

CARACTERÍSTICAS / FEATURES / CARACTÉRISTIQUES

Accesorios no incluidos / Accessories not included / Accessoires non inclus

ESPECIFICACIONES TÉCNICAS / TECHNICAL SPECIFICATION / DÉTAILS TECHNIQUES

Tipo / Type / Type	Hidráulico / Hydraulic / Hydraulique
Presión de trabajo / Working pressure / Pression de travail	140 bar
Tipo de válvula / Valve type / Type de valve	Trigger
N.º de golpes / Number of strokes / Nro. de coups	1500 rpm
Capacidad de corte / Cutting capacity / Capacité de coupe	Madera: 160 mm - Acero: 19 mm / Wood: 160 mm - Steel: 19 mm / Bois: 160 mm - Acier: 19 mm
Potencia / Power / Puissance	1,5 kW
Caudal hidráulico / Oil flow / Flux d'huile	22-50 l/min
Carrera / Stroke / Parcours	28 mm
Conexión / Connection / Connexion	1/2"FF
Nivel sonoro / Sound level / Niveau sonore	89,4 db
Nivel de vibración / Vibration level / Niveau de vibration	<2,5 m/s <sup>2</sup>
Designación ATEX / ATEX marking / Marquage ATEX	Ⓢ II 2 G c T5
Peso / Weight / Poids	6 kg

■ MEZCLADORA / MIXER / MÉLANGEUR / MIXER / MISCELATORE / MISTURADORA / МИКСЕР

La mezcladora para trabajos pesados de EGA Master es muy fácil de utilizar, gracias a su velocidad y eficacia se obtienen buenas mezclas, incluso con los materiales más exigentes.

*EGA Master heavy-duty mixer is very easy to use, and thanks to its high speed and effectiveness it obtains good mixing, even with the most demanding materials*

Le mélangeur destinés aux travaux lourds d'EGA Master est très facile à utiliser, grâce à sa vitesse et son efficacité s'obtiennent de bons mélanges, y compris avec les matériaux les plus exigeants.

■ NEUMÁTICO / PNEUMATIC / PNEUMATIQUE / PNEUMATIK / PNEUMATICA / PNEUMÁTICO / ПНЕВМАТИЧЕСКИЕ

\* G12 CE



COD.  
79619



Zonas / Zones

M2 MINERÍA / MINING / MINIÈRE

CARACTERÍSTICAS / FEATURES / CARACTÉRISTIQUES

Accesorios no incluidos / Accessories not included / Accessoires non inclus

ESPECIFICACIONES TÉCNICAS / TECHNICAL SPECIFICATION / DÉTAILS TECHNIQUES

Tipo / Type / Type	Neumático / Pneumatic / Pneumatique
Presión de trabajo / Working pressure / Pression de travail	6 bar
Máx. Ø de la herramienta / Max. Ø of the tool / Ø max. de l'outil	140 mm
Capacidad de mezclado / Mixing capacity / Capacité de mélange	50 kg
Velocidad / Speed / Vitesse	0-440 rpm
Potencia / Power / Puissance	1,1 kW
Consumo de aire / Air consumption / Consommation d'air	1,4 m <sup>3</sup> /min
Conexión / Connection / Connexion	R 3/8" male
Nivel sonoro / Sound level / Niveau sonore	79 db
Nivel de vibración / Vibration level / Niveau de vibration	<2,5 m/s <sup>2</sup>
Designación ATEX / ATEX marking / Marquage ATEX	Ⓜ I M 2 c T6
Peso / Weight / Poids	8,7 kg



\* G12: GARANTÍA 12 MESES / 12 MONTHS OF WARRANTY / 12 MOIS DE GARANTIE / 12 MONATEN GARANTIE / 12 MAANDEN GARANTIE / 12 MESI DI GARANZIA / 12 МЕСЯЦЕВ ГАРАНТИЯ

■ VENTILADOR AXIAL / AXIAL FAN / VENTILATEUR / AXIAL VENTILATOREN / VENTILATORE ASSIALE / VENTILADOR AXIAL / АКСИАЛЬНЫЙ ВЕНТИЛЯТОР

En los ventiladores axiales o helicoidales de EGA Master el aire circula en la misma dirección que su eje. Son capaces de mover grandes cantidades de aire por lo que son muy adecuados para la ventilación y la extracción de humos y gases.

EGA Master axial or helical fans circulate the air in the same direction of its axis. These fans are capable of moving large quantities of air thus they are very suitable for ventilation and smoke and gas extraction.

Dans les ventilateurs axiaux ou hélicoïdaux d'EGA Master, l'air circule dans la même direction que son axe. Ils sont capables de déplacer une grande quantité d'air, ce qui justifie leurs aptitudes pour la ventilation et l'extraction de fumées et gaz.

■ NEUMÁTICO / PNEUMATIC / PNEUMATIQUE / PNEUMATIK / PNEUMATICA / PNEUMÁTICO / ПНЕВМАТИЧЕСКИЕ

\* G12



COD.

79620

Zonas / Zones

1, 2 GAS / GAZ

CARACTERÍSTICAS / FEATURES / CARACTÉRISTIQUES

Accesorios no incluidos / Accessories not included / Accessoires non inclus

ESPECIFICACIONES TÉCNICAS / TECHNICAL SPECIFICATION / DÉTAILS TECHNIQUES

Tipo / Type / Type	Neumático / Pneumatic / Pneumatique
Ø nominal / nominal Ø / Ø nominal	300
RPM	2300 +/- 5 %
Consumo de aire / Air consumption / Consommation d'air	0,45 m <sup>3</sup> /min
Nivel sonoro / Sound level / Niveau sonore	85,7 db(A)
Longitud / Length / Longueur	350
Designación ATEX / ATEX marking / Marquage ATEX	⊕ II 2 G c IIB T6
Caudal de ventilación / Output air flow / Débit de ventilation	0,57 m <sup>3</sup> /s
Peso / Weight / Poids	13 kg
Máxima presión de trabajo / Maximum operating pressure / Pression max de travail	5 bar

\* G12



COD.

79621

79622

Zonas / Zones

1, 2 GAS / GAZ

CARACTERÍSTICAS / FEATURES / CARACTÉRISTIQUES

Accesorios no incluidos / Accessories not included / Accessoires non inclus

ESPECIFICACIONES TÉCNICAS / TECHNICAL SPECIFICATION / DÉTAILS TECHNIQUES

Tipo / Type / Type	Neumático / Pneumatic / Pneumatique
Ø nominal / nominal Ø / Ø nominal	79621 500 79622 600
Consumo de aire / Air consumption / Consommation d'air	79621 2,73 m <sup>3</sup> /min 79622 3,84 m <sup>3</sup> /min
Conexión / Connection / Connexion	Racor 42 macho 1/2" / Claw coupling 42 male 1/2" / Raccord 42 mâle 1/2"
Nivel sonoro / Sound level / Niveau sonore	79621 105 db 79622 99 db
Longitud / Length / Longueur	520
Designación ATEX / ATEX marking / Marquage ATEX	⊕ II 2 G c T6
Caudal de ventilación / Output air flow / Débit de ventilation	79621 4,33 m <sup>3</sup> /s 79622 5,83 m <sup>3</sup> /s
Peso / Weight / Poids	79621 46 kg 79622 58 kg
Máxima presión de trabajo / Maximum operating pressure / Pression max de travail	4 bar

■ VENTILADOR AXIAL / AXIAL FAN / VENTILATEUR / AXIAL VENTILATOREN / VENTILATORE ASSIALE / VENTILADOR AXIAL / АКСИАЛЬНЫЙ ВЕНТИЛЯТОР

■ ELÉCTRICO / ELECTRIC / ÉLECTRIQUE / ELEKTRISCH / ELETTRICA / ELÉTRICO / ЭЛЕКТРИЧЕСКИЙ

\* G12 CE



COD.

79623

79624



Zonas / Zones

1, 2 GAS / GAZ

CARACTERÍSTICAS / FEATURES / CARACTÉRISTIQUES

Accesorios no incluidos / Accessories not included / Accessoires non inclus

ESPECIFICACIONES TÉCNICAS / TECHNICAL SPECIFICATION / DÉTAILS TECHNIQUES

Tipo / Type / Type	Eléctrico / Electric / Électrique
Ø nominal / nominal Ø / Ø nominal	300
Velocidad nominal / Nominal speed / Vitesse nominal	
	79623 2900-4680 rpm
	79624 2870 rpm
Voltaje / Voltage / Voltage	
	79623 110 V
	79624 230 V
Consumo / Consumption / Consommation	
	79623 5,1 A
	79624 2,3 A
Frecuencia / Frequency / Fréquence	
	79623 50-60 Hz
	79624 50 Hz
Interruptor y cable de conexión / Switch and connecting cable / Interrupteur et câble de connexion	
	79623 ●
	79624 -
Nivel sonoro / Sound level / Niveau sonore	85 db
Longitud / Length / Longueur	390
Potencia de salida / Output power / Puissance de sortie	0,37 kW
Designación ATEX / ATEX marking / Marquage ATEX	Ⓔ II 2 G c IIB T3
Caudal de ventilación / Output air flow / Débit de ventilation	1 m <sup>3</sup> /s
Peso / Weight / Poids	20,5 kg

\* G12: GARANTÍA 12 MESES / 12 MONTHS OF WARRANTY / 12 MOIS DE GARANTIE / 12 MONATEN GARANTIE / 12 MAANDEN GARANTIE / 12 MESI DI GARANZIA / 12 МЕСЯЦЕВ ГАРАНТИЯ

# HYDRAULIC

HERRAMIENTA HIDRÁULICA  
*HYDRAULIC TOOLS*  
OUTILLAGE HYDRAULIQUE  
*HYDRAULISCHE WERKZEUGE*  
UTENSILERIA IDRAULICA  
*FERRAMENTA HIDRÁULICA*  
ГИДРАВЛИЧЕСКИЙ ИНСТРУМЕНТ

# 7



ATEX

Las llaves hidráulicas dinamométricas de EGA Master han sido diseñadas para el apriete controlado de conexiones tuerca-perno. El movimiento de rotación del conjunto tuerca-perno se consigue a través del flujo hidráulico y presión suministrados por las bombas hidráulicas EGA Master, con mando remoto para controlar el avance y retroceso del flujo hidráulico.

La gama EGA Master de llaves hidráulicas dinamométricas de cuadrado conductor (para trabajar con llaves de vaso de impacto) o de cassettes hexagonales (no requieren de vaso adicional) permiten el apriete de una de las más amplias gamas de medidas tanto en milímetros como en pulgadas. Sus reducidas dimensiones, junto con su alta durabilidad, las hacen indispensables en una gran variedad de sectores: petroquímico, eólico, generación de energía, naval, etc.

*EGA Master's hydraulic torque wrenches have been designed for controlled tightening of nut-bolt connections. The remotely controlled hydraulic flow and pressure supplied by EGA Master hydraulic power units provide the rotation of the nut on the bolt.*

*The assortment of square drive and hexagonal cassettes hydraulic torque wrenches allows tightening of a very wide range of nut sizes, both in millimeters and inches. Their small dimensions and high durability make them the perfect tool for several sectors: petrochemical industry, wind sector, power generation, naval sector, etc. Square drive wrenches need additional impact socket wrenches while hexagonal cassette ones don't.*

Les clés hydrauliques dynamométriques d'EGA Master ont été conçues pour le serrage contrôlé de connexions écrou-boulon. Le mouvement de rotation de l'ensemble écrou-boulon s'obtient à travers le flux hydraulique et la pression fournie par les pompes hydrauliques EGA Master, commande à distance afin de contrôler l'avancée et de recul les flux hydrauliques.

La gamme EGA Master de clés hydrauliques dynamométriques à carré conducteur (pour travailler avec les douilles à choc) ou de cassettes hexagonales (qui n'ont pas besoin de clé additionnelle) permettent le serrage d'une des plus larges gammes de mesures autant en mm qu'en pouces. Ses dimensions réduites ainsi que sa haute durabilité, les font indispensables dans une grande variété de secteurs: pétrochimique, éolien, production d'énergie, navale, etc.



#### Características comunes

Su conector hidráulico de 360°x360° facilita el uso de la llave al permitir una movilidad total de la manguera.

#### Common features

The 360°x360° swivel allows a total mobility of the hose, making its use easy and comfortable.

#### Caractéristiques communes

Son connecteur hydraulique de 360°x360° facilite l'usage de la clé car elle permet une mobilité totale du tuyau.



LLAVES HIDRÁULICAS DE CUADRADO  
SQUARE DRIVE TORQUE WRENCHES  
CLÈS HYDRAULIQUES À CARRÉ



Tabla de aprietes grabada en láser para un acceso más rápido.

*Laser engraved torque chart for faster access.*

Table de serrages gravée à laser pour un accès plus rapide.

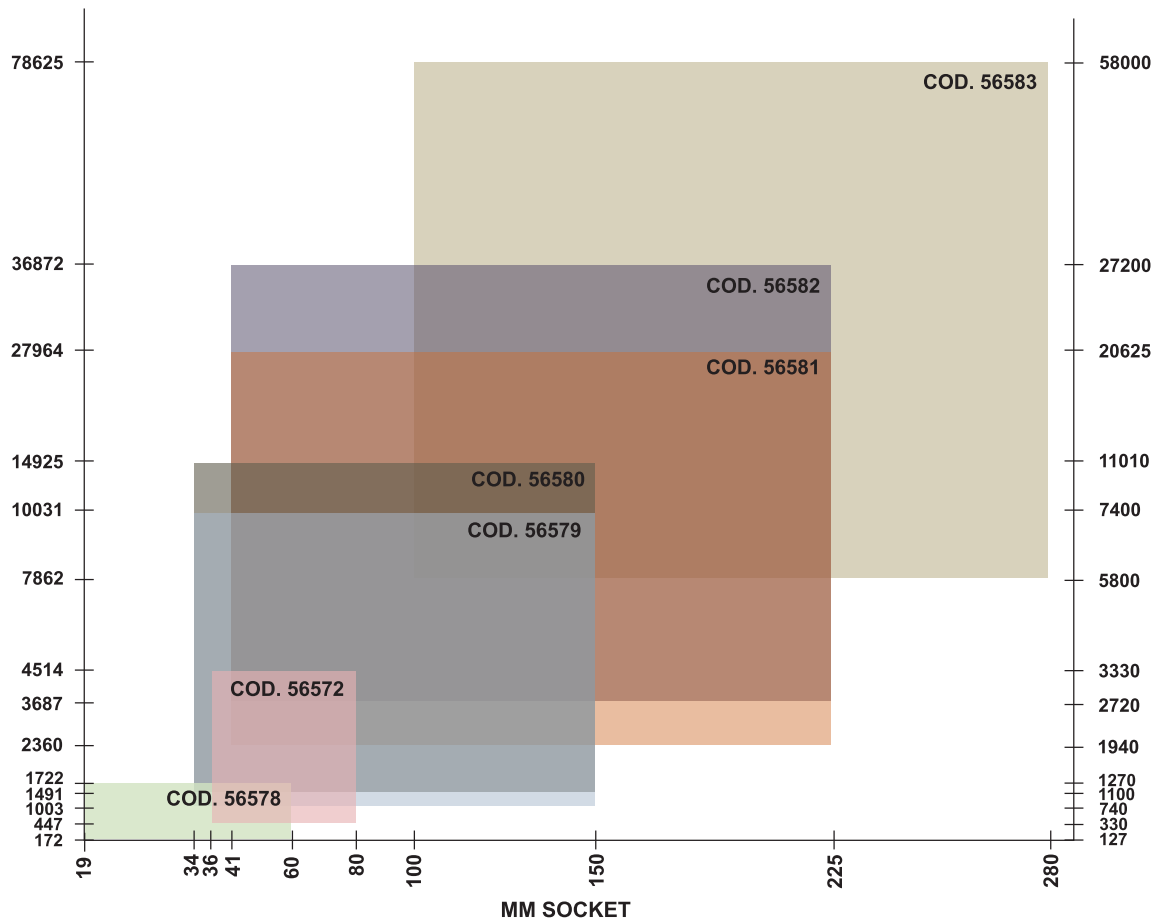

• Brazo de reacción giratorio 360° para una correcta fijación en cualquier aplicación.

*360° swivel reaction arm for a correct fitting on any application.*

• Bras de réaction giratoire 360° pour une fixation correcte dans n'importe quelle application.

• Permite el uso de la herramienta sin brazo de reacción.

*Allows the use of the tool without reaction arm.*

• Permet l'utilisation de l'outil sans bras de réaction.

• Permite un cambio rápido de sentido presionando únicamente el cuadrado conductor, sin necesidad de herramientas adicionales (códigos 56578, 56572, 56579, 56580).

*Allows quick change of direction pushing the square drive, without additional tools (codes 56578, 56572, 56579, 56580).*

• Permet un changement rapide de sens en appuyant uniquement sur le carré conducteur, sans nécessité d'outils additionnels (codes 56578, 56572, 56579, 56580).

**LLAVES DINAMOMÉTRICAS HIDRÁULICAS DE CUADRADO CONDUCTOR / SQUARE DRIVE HYDRAULIC TORQUE WRENCHES / CLÉS DYNAMOMÉTRIQUES HYDRAULIQUES DE CARRÉ CONDUCTEUR / QUADRAT HYDRAULISCHE DREHMOMENTSCHLÜSSEL / CHIAVI DINAMOMETRICHE IDRAULICHE CON ATTACCO QUADRO / CHAVES DINAMOMÉTRICAS HIDRÁULICAS DE QUADRADO CONDUTOR / ГИДРАВЛИЧЕСКИЙ ДИНАМОМЕТРИЧЕСКИЙ КЛЮЧ С ПРИСОЕДИНИТЕЛЬНЫМ КВАДРАТОМ**

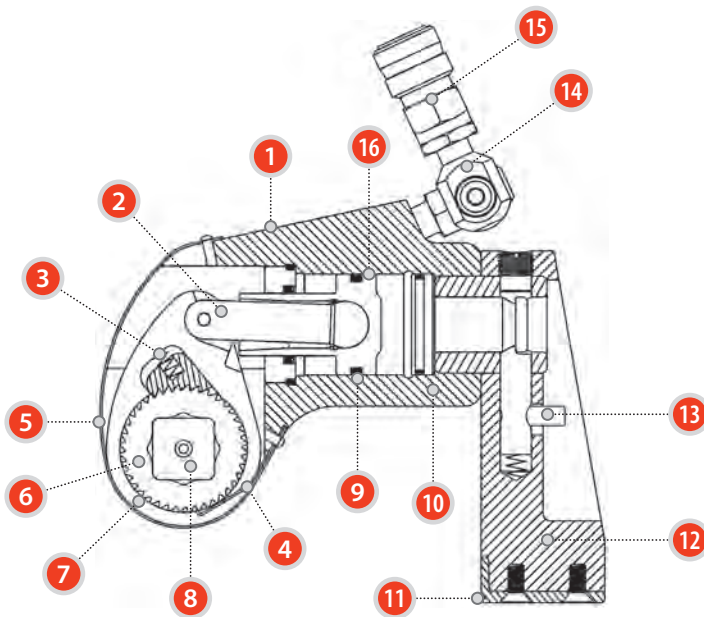

- 1 Chasis de un solo cuerpo / Mono-body housing / Châssis d'un seul corps**
- 2 Vástago de empuje oscilante / Balanced drive rod / Tige à poussée oscillante**  
Movimiento del pistón sin cargas / Wide load-free piston movement / Mouvement du piston sans charges
- 3 Cremallera multidentada / Multi-tooth drive segment / Crémaillère multi dentelée**  
Asegura una carrera de apriete de 27 grados / Ensures up to 27 degree torque stroke / Assure un parcours de serrage de 27 degrés
- 4 Carraca Anti-Retroceso / Anti-back lash mechanism / Cliquet Anti-Recul**  
Permite su operación sin manos / Provides hands free operation / Permet son opération sans mains
- 5 Tabla de torsiones grabada con láser / Laser engraved torque chart / Plaque de torsion gravée au laser**  
No más búsquedas de las tablas / No more searching for charts / Plus de recherches des plaques
- 6 Rueda multidentada / Multi-tooth ratchet / Roue multi dentelée**  
Los fuertes dientes de Vascomax aportan fuerza, precisión y un ángulo de apriete de 27 grados / Strong Vascomax teeth provide strength, accuracy and 27 degree torque stroke / Les fortes dents de Vascomax apportent force, précision et angle de serrage de 27 degrés
- 7 Disco transmisión de una sola pieza / One piece drive plate / Disque transmission d'une seule pièce**  
El disco de transmisión de Vascomax de una pieza proporciona una mayor vida útil e incrementa la durabilidad / One piece Vascomax drive plate provides longer life and increased durability / Le disque transmission de Vascomax d'une pièce proportionne une vie utile supérieure et augmente la durabilité
- 8 Conductor a través de empuje / Push-through drive / Conducteur à travers la poussée**  
Empuje simple para cambiar de aflojar a apretar / Simply push to switch from loosen to tighten / Poussée simple pour changer de desserrer à serrer
- 9 Junta de pistón individual / Single seal piston / Joint de piston individuel**  
Aumenta el tiempo de trabajo sin mantenimientos / Assures extended maintenance free operation / Augmente le temps de travail sans maintenances
- 10 Acción directa sobre el chasis / Direct housing reaction / Action directe sur le châssis**  
Permite el uso de la herramienta sin el brazo de reacción / Allows use of tool without reaction arm / Permet l'utilisation de l'outil sans le bras de réaction
- 11 Extremo del brazo de reacción de acero / Steel reaction boot / Extrémité du bras de réaction en acier**  
La característica de campo sustituible protege el brazo de reacción / Field replaceable feature protects reaction arm / La caractéristique du champ remplaçable protège le bras de réaction
- 12 Brazo de reacción de larga longitud / Long length reaction arm / Bras de réaction de longue longueur**  
Permite su apoyo en todas las aplicaciones / Allows for reaction on all applications / Permet son appui dans toutes les applications
- 13 Botón de liberación del brazo de reacción / Reaction arm release button / Bouton de libération du bras de réaction**  
Protegido dentro de la carcasa del brazo de reacción / Protected within reaction arm housing / Protéger dans la carcasse du bras de réaction
- 14 Conector giratorio 360°x360° / 360°x360° swivel / Connecteur giratoire 360°x360°**  
Permite el despeje de las mangueras en todas las aplicaciones / Allows hose to be cleared on all applications / Permet le dégagement des tuyaux dans toutes les applications
- 15 Rápidas conexiones antigoteo / No drip quick connect couplers / Connexions anti-goutte rapides**  
Asegura un manejo fácil y seguro / Assures easy and safe operation / Assure un maniement facile et sûr
- 16 Pistón de aleación de acero / Steel alloy piston / Piston d'alliage en acier**  
Una composición robusta permite un ciclo de trabajo mayor / Robust composition allows for longer operation cycle / Une composition robuste permet un cycle plus long de travail



LLAVES HIDRÁULICAS DE CASSETTE HEXAGONAL  
HEXAGONAL CASSETTES TORQUE WRENCHES  
CLÉS HYDRAULIQUES À CASSETTE HEXAGONALE

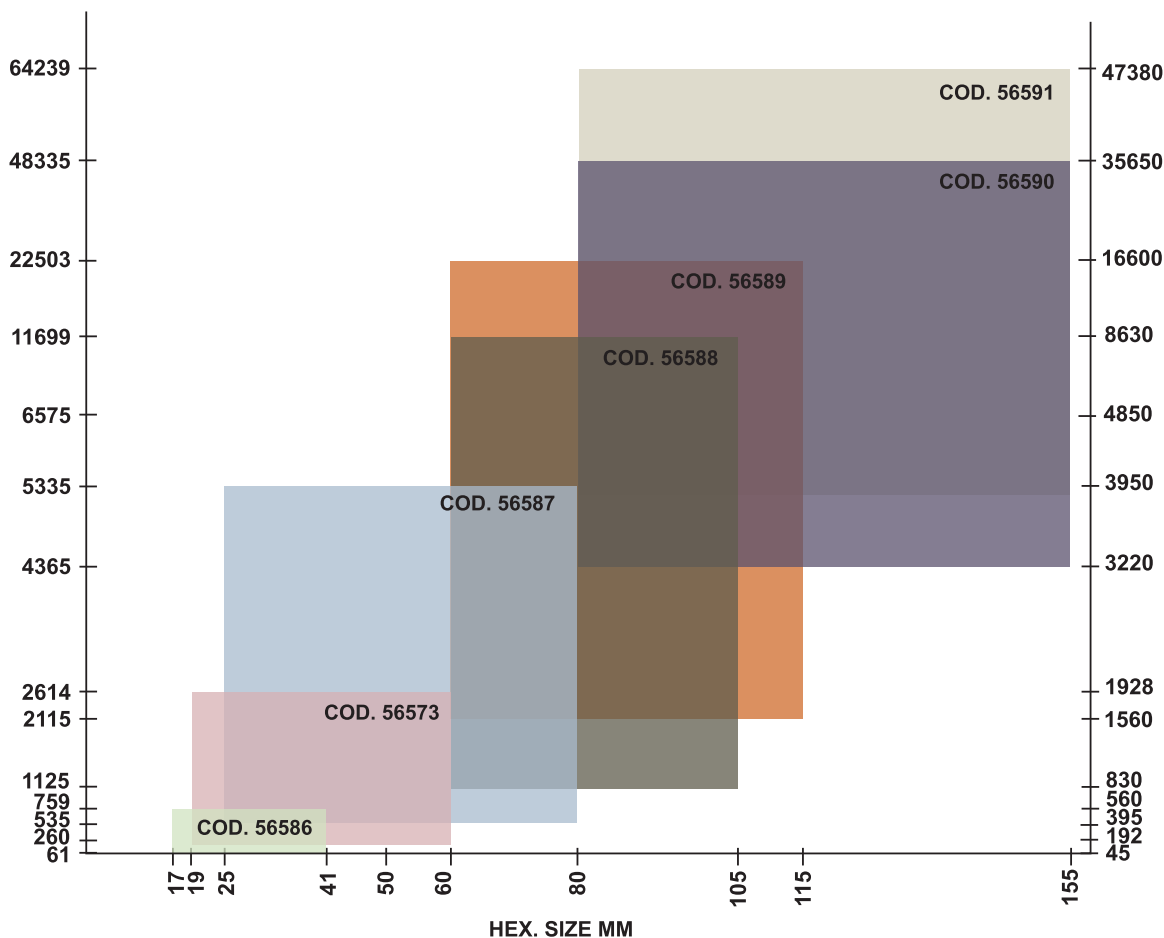

Tamaño compacto para uso en lugares inaccesibles.

Compact size for use in inaccessible places.

Taille compacte pour l'utilisation dans des lieux inaccessibles.



Sin herramientas. Basta con extraer fácilmente el pasador para el cambio del cassette.

Without tools. The pin can be easily removed to change the cassette.

Sans outils. Il suffit d'extraire facilement la tige pour le changement de cassette.

Pequeño radio que permite su uso en espacios reducidos.

Small nose radius to use in small spaces.

Petit rayon qui permet son utilisation dans des espaces réduits.

LLAVES DINAMOMÉTRICAS HIDRÁULICAS HEXAGONALES / HEXAGONAL HYDRAULIC TORQUE WRENCHES / CLÉS DYNAMOMÉTRIQUES HYDRAULIQUES  
HEXAGONALES / HEX HYDRAULISCHE DREHMOMENTSCHLÜSSEL / CHIAVI DINAMOMETRICHE IDRAULICHE ESAGONALI / CHAVES DINAMOMÉTRICAS HIDRÁULICAS  
HEXAGONAIS / ГИДРАВЛИЧЕСКИЙ ДИНАМОМЕТРИЧЕСКИЙ КЛЮЧ КАССЕТНОГО ТИПА ШЕСТИГРАННЫЙ

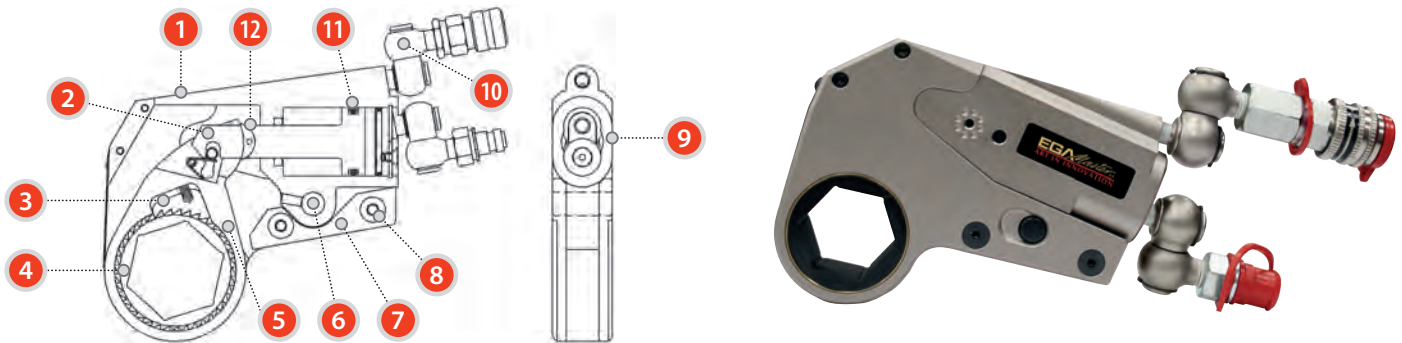

1 Cilindro con "forma de cacahuete" / "Peanut-shaped" cylinder / Cylindre en "forme de cacahuète"

Fije tanto el cilindro como el cassette en zonas de difícil acceso / Fit both the cylinder and link in confined areas / Fixez le cylindre et la cassette dans les zones de difficile accès.

2 Acoplamiento del pistón / Engagement rod / Couplage du piston

En el primer movimiento embraga automáticamente / Automatically engages link on the first stroke / Dans le premier mouvement embraye automatiquement

3 Trinquete anti-bloqueo / Never-lock drive paw / Cliquet anti blocage

Asegura que no se bloquee nunca la herramienta / Ensures tool will never lock on / Assure que l'outil ne se bloque jamais

4 Trinquete multi-dentado / Multi-tooth ratchet / Cliquet multi dentelé

Permite una precisión de carrera de apriete de 27 grados / Allows for 27 degree torque stroke accuracy / Permet une précision de parcours de serrage de 27 degrés

5 Disco de arrastre de una sola pieza / One piece drive plate / Disque de trainage d'une seule pièce

Una combinación robusta que permite radios de curvatura pequeños / Robust alloy provides for small nose radius / Une combinaison robuste qui permet d'obtenir des petits rayons de courbure

6 Pasador de enganche / Link pin / Goupille d'accrochage

Pasador para engancharlo al engranaje del cilindro. No se necesitan herramientas / One pin for link to cylinder engagement, no tools required / Tige de crochet pour l'accrocher à l'engrenage du cylindre. Pas besoin d'outils

7 Superficie de reacción en línea / In-line reaction pad / Surface de réaction en ligne

Asegura todo el tiempo una reacción libre / Assures free reaction every time / Assure tout le temps une réaction libre

8 Pasador de alineación de acero / Steel alignment pin / Tige d'alignement en acier

Asegura una carga de desplazamiento igual entre las placas laterales / Assures equal load displacement between side plates / Assure une charge de déplacement pareil entre les plaques latérales

9 Diseño completamente delgado / Completely flat design / Design complètement mince

El ancho del cilindro y del cassette son iguales para espacios estrechos / Cylinder and link width are equal for tight fits / La largeur du cylindre et de la cassette son pareil pour des espaces étroits

10 Conector 360°x360° / 360°x360° swivel / Connecteur 360°x360°

Permite el despeje de las mangueras en todas las aplicaciones / Allows hose to be cleared on all applications / Permet le dégagement des tuyaux d'arrosage dans toutes les applications

11 Sellado hermético de teflón / Proprietary piston seal / Scellé hermétiquement en téflon

Evita tareas de mantenimiento durante años / Provides years of maintenance free use / Évite les tâches de maintenance pendant des années

12 Pasador / Slider / Tige

Evita el desgaste del pistón y del disco de transmisión y reduce los costes de reparación / Prevents wear of piston and drive plate and reduces cost of repairs / Évite l'usure du piston et du disque de transmission et réduit les coûts de réparation

■ ALGUNAS SITUACIONES DONDE PUEDEN SER ÚTILES LAS LLAVES HIDRÁULICAS HEXAGONALES  
SOME SITUATIONS WHERE HEXAGONAL TORQUE WRENCHES CAN BE USEFUL  
QUELQUES SITUATIONS OÙ LES CLÉS HYDRAULIQUES HEXAGONALES PEUVENT ÊTRE UTILES

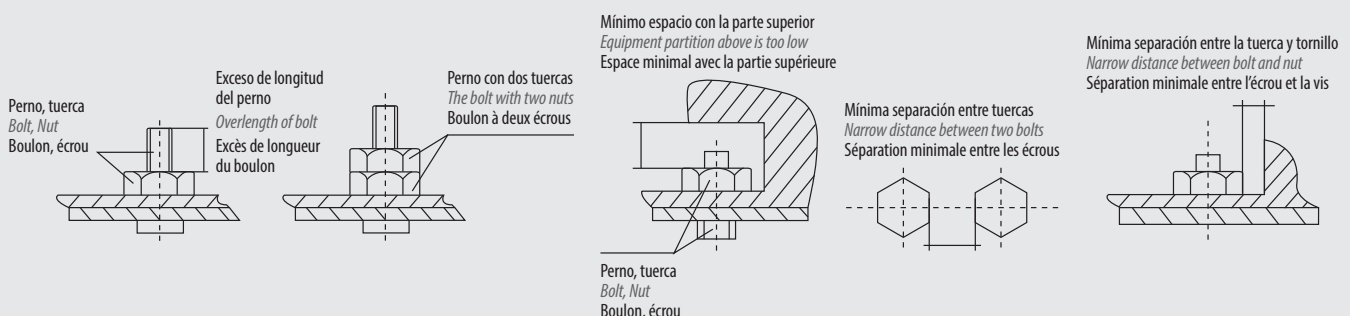

**LLAVES DINAMOMÉTRICAS HIDRÁULICAS DE CUADRADO CONDUCTOR / SQUARE DRIVE HYDRAULIC TORQUE WRENCHES / CLÉS DYNAMOMÉTRIQUES HYDRAULIQUES DE CARRÉ CONDUCTEUR / QUADRAT HYDRAULISCHE DREHMOMENTSCHLÜSSEL / CHIAVI DINAMOMETRICHE IDRAULICHE CON ATTACCO QUADRO / CHAVES DINAMOMÉTRICAS HIDRÁULICAS DE QUADRADO CONDUTOR / ГИДРАВЛИЧЕСКИЙ ДИНАМОМЕТРИЧЕСКИЙ КЛЮЧ С ПРИСОЕДИНИТЕЛЬНЫМ КВАДРАТОМ**

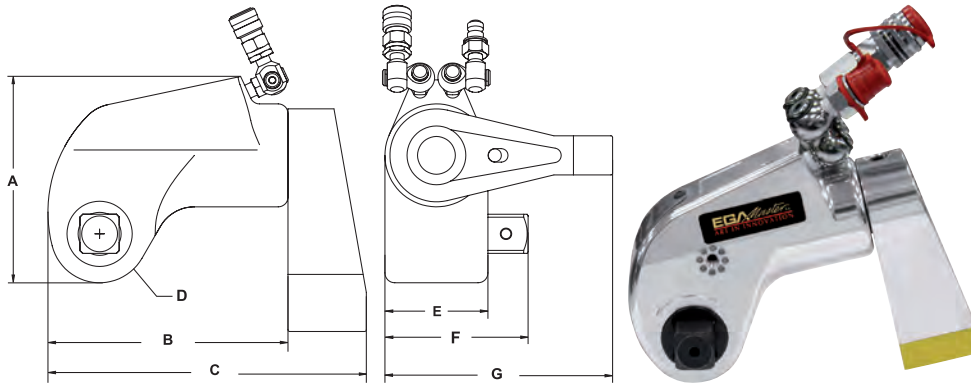

COD.	AF inch	N.m	Ft.lb	Precisión / Accuracy / Précision	Repit.	Ciclo de trabajo / Duty cycle / Cycle de travail	A (mm)	B (mm)	C (mm)	D (mm)	E (mm)	F (mm)	G (mm)	Kg
56578	3/4	172-1722	127-1270				105	120	160	25	50	70	110	1,7
56572	1	447-4514	330-3330				135	155	210	33	65	95	150	4,0
56579	1.1/2	1003-10031	740-7400				180	210	280	45	90	130	200	8,5
56580		1491-14925	1100-11010	±3%	100%	100%	200	230	310	49	100	140	220	13
56581		2630-27964	1940-20625				230	240		60	125	180	280	28
56582	2.1/2	3687-36872	2720-27200				260	310	410	65	135	190	300	32
56583		7862-78625	5800-58000				290	390	520	80	165	230	360	60

G12

**LLAVES DINAMOMÉTRICAS HIDRÁULICAS HEXAGONALES / HEXAGONAL HYDRAULIC TORQUE WRENCHES / CLÉS DYNAMOMÉTRIQUES HYDRAULIQUES HEXAGONALES / HEX HYDRAULISCHE DREHMOMENTSCHLÜSSEL / CHIAVI DINAMOMETRICHE IDRAULICHE ESAGONALI / CHAVES DINAMOMÉTRICAS HIDRÁULICAS HEXAGONAIS / ГИДРАВЛИЧЕСКИЙ ДИНАМОМЕТРИЧЕСКИЙ КЛЮЧ КАСЕТНОГО ТИПА ШЕСТИГРАННЫЙ**

**UNIDAD DE IMPULSIÓN / DRIVE UNIT / UNITÉ D'IMPULSION / ANTRIEB / UNITÀ DISCO / UNIDADE DE IMPULSÃO / СИЛОВОЙ ПРИВОД**

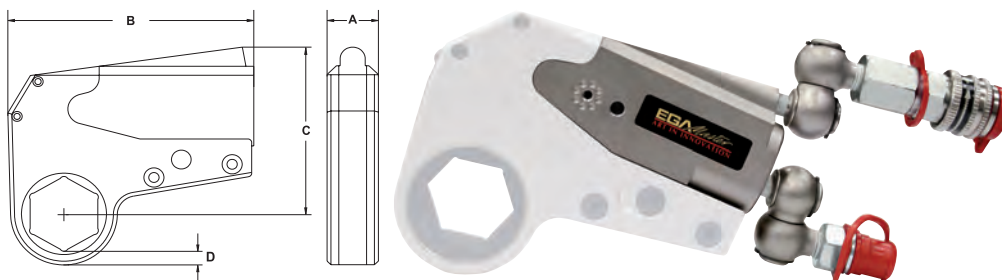

COD.		N.m	Ft.lb	Kg	Kg	Precisión / Accuracy / Précision	Repit.	Ciclo de trabajo / Duty cycle / Cycle de travail	A (mm)	B (mm)	C (mm)	D (mm)
56586	56594, 56620	61-759	45-560	0,5	0,5				20	110	85	6
56573	56621, 56653, 56574	260-2614	192-1928	1,5	1,0-1,5				32	165	100	9
56587	56654, 56691	535-5335	395-3950	2,7	2,4-3,4				41	200	145	12
56588	56692, 56732	1125-11699	830-8630	5	5,5-6,5	±3%	100%	100%	50	260	180	14
56589	56733, 56790	2115-22503	1560-16600	7,5	9,5-13				65	330	195	17
56590		4365-48335	3220-35650	12	13- 18				80	400	240	
56591	56791, 56882	6575-64239	4850-47380	13	13-18				125	430	260	24

G12

**CARACTERÍSTICAS / FEATURES / CARACTÉRISTIQUES**



Cassete no incluido / Cassete not included / Cassete non incluse

G12 GARANTIA 12 MESES / 12 MONTHS OF WARRANTY / 12 MOIS DE GARANTIE / 12 MONATEN GARANTIE / 12 MAANDEN GARANTIE / 12 MESI DI GARANZIA / 12 МЕСЯЦЕВ ГАРАНТИЯ

**CASSETTES HEXAGONALES / HEXAGONAL LINKS / CASSETTES HEXAGONALES / HEX VERBINDUNGEN / CASSETTE ESAGONALI / MATRIZES HEXAGONAIS / КАССЕТЫ СМЕННЫЕ ШЕСТИГРАННЫЕ**



COD.		(mm)	(inch)	COD.		(mm)	(inch)
56594	56586	-	1/2	56643	56573	50	-
56595		13	-	56644		2	
56596		-	9/16	56645		-	2.1/16
56597		14	-	56646		2.1/8	
56598		-	5/8	56647		55	2.3/16
56599		15	-	56648		-	2.1/4
56600		17	-	56649		-	2.5/16
56601		-	11/16	56650		60	2.3/8
56602		19	3/4	56651		-	2.7/16
56603		-	13/16	56652		-	2.1/2
56604		21	-	56653	65	2.9/16	
56605		22	7/8	56654	-	1	
56606		-	15/16	56655	27	1.1/16	
56607		24	-	56656	-	1.1/8	
56608		-	1	56657	30	1.3/16	
56609		27	1.1/16	56658	-	1.1/4	
56610		-	1.1/8	56659	32	-	
56611		30	1.3/16	56660	-	1.5/16	
56612		-	1.1/4	56661	35	1.3/8	
56613		32	-	56662	36	-	
56614	-	1.5/16	56663	-	1.7/16		
56615	35	1.3/8	56664	38	1.1/2		
56616	36	-	56665	-	1.9/16		
56617	-	1.7/16	56666	41	1.5/8		
56618	38	1.1/2	56667	-	1.11/16		
56619	-	1.9/16	56668	-	1.3/4		
56620	41	1.5/8	56669	46	1.13/16		
56621	19	3/4	56670	-	1.7/8		
56622	-	13/16	56671	49	1.15/16		
56623	22	7/8	56672	50	-		
56624	-	15/16	56673	56587	2		
56625	24	-	56674	-	2.1/16		
56626	-	1	56675	-	2.1/8		
56627	27	1.1/16	56676	55	2.3/16		
56628	-	1.1/8	56677	-	2.1/4		
56629	30	1.3/16	56678	-	2.5/16		
56630	-	1.1/4	56679	60	2.3/8		
56631	32	-	56680	-	2.7/16		
56632	56573	-	56681	-	2.1/2		
56633	-	1.5/16	56682	65	2.9/16		
56634	35	1.3/8	56683	-	2.5/8		
56635	36	-	56684	-	2.11/16		
56636	-	1.7/16	56685	70	2.3/4		
56574	38	1.1/2	56686	-	2.13/16		
56637	41	1.5/8	56687	-	2.7/8		
56638	-	1.11/16	56688	75	2.15/16		
56639	-	1.3/4	56689	3			
56640	46	1.13/16	56690	-	3.1/16		
56641	-	1.7/8	56691	-	3.1/8		
56642	49	1.15/16	56692	80	-		
			56693	49	1.15/16		
			56694	50	-		
			56695	56588	2		
			56696	-	2.1/16		
			56697	-	2.1/8		
			56698	55	2.3/16		
			56699	-	2.1/4		
			56700	56588	-	2.5/16	
			56701	60	2.3/8		
			56702	-	2.7/16		
			56703	-	2.1/2		
			56704	65	2.9/16		
			56705	-	2.5/8		
			56706	-	2.11/16		
			56707	70	2.3/4		
			56708	-	2.13/16		
			56709	-	2.7/8		
			56710	75	2.15/16		
			56711	-	3		
			56712	-	3.1/16		
			56713	-	3.1/8		
			56714	80	-		
			56715	-	3.3/16		
			56716	56588	-	3.1/4	
			56717	-	3.5/16		
			56718	85	-		
			56719	-	3.3/8		
			56720	-	3.7/16		
			56721	-	3.1/2		
			56722	90	-		
			56723	-	3.9/16		
			56724	-	3.5/8		
			56725	-	3.11/16		
			56726	95	3.3/4		
			56727	-	3.13/16		
			56728	-	3.7/8		
			56729	100	3.15/16		
			56730	-	4		
			56731	-	4.1/16		
			56732	105	4.1/8		
			56733	55	2.3/16		
			56734	-	2.1/4		
			56735	-	2.5/16		
			56736	60	2.3/8		
			56737	-	2.7/16		
			56738	-	2.1/2		
			56739	65	2.9/16		
			56740	-	2.5/8		
			56741	-	2.11/16		
			56742	70	2.3/4		
			56743	-	2.13/16		
			56744	-	2.7/8		
			56745	56589	75	2.15/16	
			56746	-	3		
			56747	-	3.1/16		
			56748	-	3.1/8		
			56749	80	-		
			56750	-	3.3/16		
			56751	-	3.1/4		
			56752	-	3.5/16		
			56753	85	-		
			56754	-	3.3/8		
			56755	-	3.7/16		
			56756	-	3.1/2		

COD.		(mm)	(inch)	COD.		(mm)	(inch)	COD.		(mm)	(inch)
56757		90	-	56817		-	4.1/2	56877		-	7.9/16
56758		-	3.9/16	56818		115	-	56878		-	7.5/8
56759		-	3.5/8	56819		-	4.9/16	56879	56590, 56591	195	7.11/16
56760		-	3.11/16	56820		-	4.5/8	56880		-	7.3/4
56761		95	3.3/4	56821		-	4.11/16	56881		-	7.13/16
56762		-	3.13/16	56822		120	-	56882		200	7.7/8
56763		-	3.7/8	56823		-	4.3/4				
56764		100	3.15/16	56824		-	4.13/16				
56765		-	4	56825		-	4.7/8				
56766		-	4.1/16	56826		125	-				
56767		105	4.1/8	56827		-	4.15/16				
56768		-	4.3/16	56828		-	5				
56769		-	4.1/4	56829		-	5.1/16				
56770		-	4.5/16	56830		130	5.1/8				
56771		110	-	56831		-	5.3/16				
56772		-	4.3/8	56832		-	5.1/4				
56773	56589	-	4.7/16	56833		135	5.5/16				
56774		-	4.1/2	56834		-	5.3/8				
56775		115	-	56835		-	5.7/16				
56776		-	4.9/16	56836		140	5.1/2				
56777		-	4.5/8	56837		-	5.9/16				
56778		-	4.11/16	56838		-	5.5/8				
56779		120	-	56839		-	5.11/16				
56780		-	4.3/4	56840		145	-				
56781		-	4.13/16	56841		-	5.3/4				
56782		-	4.7/8	56842		-	5.13/16				
56783		125	-	56843		-	5.7/8				
56784		-	4.15/16	56844		150	-				
56785		-	5	56845		-	5.15/16				
56786		-	5.1/16	56846	56590, 56591	-	6				
56787		130	5.1/8	56847		-	6.1/16				
56788		-	5.3/16	56848		155	-				
56789		-	5.1/4	56849		-	6.1/8				
56790		135	5.5/16	56850		-	6.3/16				
56791		-	3.1/8	56851		-	6.1/4				
56792		80	-	56852		160	-				
56793		-	3.3/16	56853		-	6.5/16				
56794		-	3.1/4	56854		-	6.3/8				
56795		-	3.5/16	56855		-	6.7/16				
56796		85	-	56856		165	6.1/2				
56797		-	3.3/8	56857		-	6.9/16				
56798		-	3.7/16	56858		-	6.5/8				
56799		-	3.1/2	56859		170	6.11/16				
56800		90	-	56860		-	6.3/4				
56801		-	3.9/16	56861		-	6.13/16				
56802		-	3.5/8	56862		-	6.7/8				
56803	56590, 56591	-	3.11/16	56863		175	-				
56804		95	3.3/4	56864		-	6.15/16				
56805		-	3.13/16	56865		-	7				
56806		-	3.7/8	56866		-	7.1/16				
56807		100	3.15/16	56867		180	-				
56808		-	4	56868		-	7.1/8				
56809		-	4.1/16	56869		-	7.3/16				
56810		105	4.1/8	56870		-	7.1/4				
56811		-	4.3/16	56871		185	-				
56812		-	4.1/4	56872		-	7.5/16				
56813		-	4.5/16	56873		-	7.3/8				
56814		110	-	56874		-	7.7/16				
56815		-	4.3/8	56875		190	-				
56816		-	4.7/16	56876		-	7.1/2				

G12

G12 GARANTIA 12 MESES / 12 MONTHS OF WARRANTY / 12 MOIS DE GARANTIE / 12 MONATEN GARANTIE / 12 MAANDEN GARANTIE / 12 MESI DI GARANZIA / 12 МЕСЯЦЕВ ГАРАНТИЯ

Si no encuentra el artículo que necesita, consúltenos en [info@egamaster.com](mailto:info@egamaster.com) o en [www.egamaster.com](http://www.egamaster.com)  
 If you can't find the item you look for, please ask us in [info@egamaster.com](mailto:info@egamaster.com) or in [www.egamaster.com](http://www.egamaster.com)  
 Si vous ne trouvez pas l'article que vous desirez, consultez-nous a [info@egamaster.com](mailto:info@egamaster.com) ou a [www.egamaster.com](http://www.egamaster.com)

**BOMBAS HIDRÁULICAS / HYDRAULIC POWER UNIT PUMP / POMPES HYDRAULIQUES / HYDRAULISCHE PUMPE / POMPE IDRAULICHE / BOMBAS HIDRÁULICAS / ГИДРАВЛИЧЕСКАЯ СТАНЦИЯ**

Las bombas hidráulicas de EGA Master han sido diseñadas de acuerdo a las necesidades del usuario final. Disponibles para el funcionamiento con una única herramienta o con hasta cuatro herramientas simultáneamente, estas bombas están fabricadas para trabajar en entornos adversos, y permiten el ajuste de la presión deseada para garantizar la salida de par correcta a su aplicación.

Además de las bombas de accionamiento eléctrico (115VAC o 230VAC), EGA Master ofrece bombas de accionamiento neumático para ambientes explosivos o en aplicaciones donde la electricidad esté inaccesible.

*EGA Master's hydraulic power unit pumps have been designed according to the needs of the end user. They enable simultaneous use of four wrenches. EGA Master power units are manufactured to work in adverse environments, allowing pressure adjustment to assure the correct torque output to each application.*

*In addition to the electric drive hydraulic pumps (115VAC or 230VAC), EGA Master provides air drive hydraulic pumps to use them in explosive environments or in applications where the electricity is not available.*

Les pompes hydrauliques d'EGA Master ont été conçues selon les nécessités de l'utilisateur final. Disponibles pour le fonctionnement avec un seul outil ou même quatre outils simultanément, ces pompes sont fabriquées pour travailler dans des environnements adverses, et permettent l'ajustement de la pression désirée pour garantir la sortie correcte de couple pendant son application.

En plus des pompes d'actionnement électrique (115VAC o 230VAC), EGA Master offre des pompes d'actionnement pneumatique pour des environnements explosifs ou dans des applications où l'électricité est inaccessible.

**DE ACCIONAMIENTO ELÉCTRICO / ELECTRIC DRIVE / D'ACCIONNEMENT ÉLECTRIQUE / ELECTRISCHE ANTRIEB / AVVIAMENTO ELETTRICO / DE ACCIONAMENTO ELÉCTRICO / ГИДРАВЛИЧЕСКАЯ СТАНЦИЯ С ЭЛЕКТРОПРИВОДОМ**

COD.	kW	V	CAP. L
56888	0,8	115 VAC	5,5
56889		230 VAC	

CE | G12

**ESPECIFICACIONES TÉCNICAS / TECHNICAL SPECIFICATION / DÉTAILS TECHNIQUES**

Puertos / Ports / Ports	1
Para uso con / For use with / Pour utilisation avec	56572, 56573, 56578, 56579, 56586, 56587, 56588
Caudal / Flow rate / Débit	8,6l/min. @ 75 bar / 0,75l/min @ 700 bar
Botón de control de presión / Pressure control button / Bouton de contrôle de pression	●
Mando de control remoto (4 m) / Remote pendant (4 m) / Commande à distance (4 m)	●
Manguera hidráulica doble / Tinline Hydraulic hose / Tuyau hydraulique double	4 m
Peso sin aceite / Weight without oil / Poids sans huile	22 Kg



COD.	kW	V	CAP. L
56885	1,1	115 VAC	5,5
56575		230 VAC	
56886		115 VAC	7,5
56887		230 VAC	

CE | G12

**ESPECIFICACIONES TÉCNICAS / TECHNICAL SPECIFICATION / DÉTAILS TECHNIQUES**

Puertos / Ports / Ports	56885 1
	56575 1
	56886 4
	56887 4
Para uso con / For use with / Pour utilisation avec	56572, 56573, 56578, 56579, 56580, 56581, 56582, 56583, 56586, 56587, 56588, 56589, 56590, 56591
Caudal / Flow rate / Débit	11,5l/min. @ 75 bar / 0,9l/min @ 700 bar
Botón de control de presión / Pressure control button / Bouton de contrôle de pression	●
Mando de control remoto (4 m) / Remote pendant (4 m) / Commande à distance (4 m)	●
Manguera hidráulica doble / Tinline Hydraulic hose / Tuyau hydraulique double	4 m
Peso sin aceite / Weight without oil / Poids sans huile	56885 29 Kg
	56575 29 Kg
	56886 30 Kg
	56887 30 Kg



**DE ACCIONAMIENTO NEUMÁTICO / AIR DRIVE / D'ACCIONNEMENT PNEUMATIQUE / PNEUMATISCHER ANTRIEB / AVVIAMENTO PNEUMATICO / DE ACCIONAMIENTO PNEUMÁTICO / ГИДРАВЛИЧЕСКАЯ СТАЦИЯ С ПНЕВМОПРИВОДОМ**

COD.	kW	
<b>56890</b>		
	4,5	7,5
<b>56891</b>		

CE I G12

**ESPECIFICACIONES TÉCNICAS / TECHNICAL SPECIFICATION / DÉTAILS TECHNIQUES**

Puertos / Ports / Ports		
	<b>56890</b>	1
	<b>56891</b>	4
Para uso con / For use with / Pour utilisation avec	56572, 56573, 56578, 56579, 56580, 56581, 56582, 56583, 56586, 56587, 56588, 56589, 56590, 56591	
Caudal / Flow rate / Débit	11,5l/min. @ 75 bar / 0,9l/min @ 700 bar	
Botón de control de presión / Pressure control button / Bouton de contrôle de pression	●	
Mando de control remoto (4 m) / Remote pendant (4 m) / Commande à distance (4 m)	●	
Manguera hidráulica doble / Twinline Hydraulic hose / Tuyau hydraulique double	4 m	
Peso sin aceite / Weight without oil / Poids sans huile	33 Kg	



**ACCESORIOS / ACCESSORIES / ACCESSOIRES / ERSATZTEILE / ACCESSORI / ACESSORIOS / ЗАПАСНЫЕ ЧАСТИ**

COD.	Descripción / Description / Description	
<b>56893</b>	Colector de 4 puertos / 4 ports manifold / Collecteur de 4 ports	4,0

G12

**ESPECIFICACIONES TÉCNICAS / TECHNICAL SPECIFICATION / DÉTAILS TECHNIQUES**

Para bombas / For pumps / Pour pompes	56885, 56575, 56890
---------------------------------------	---------------------



N!

COD.		Descripción / Description / Description	
<b>79815</b>	20	Aceite hidráulico / Hydraulic oil / Huile hydraulique	17

**ESPECIFICACIONES TÉCNICAS / TECHNICAL SPECIFICATION / DÉTAILS TECHNIQUES**

Para bombas / For pumps / Pour pompes	56888, 56889, 56885, 56575, 56886, 56887, 56890, 56891, 79785
---------------------------------------	---



**BE SAFE...BE EFFICIENT**

**ROMPETUERCAS HIDRÁULICO / HYDRAULIC NUT SPLITTER / CASSE-ÉCROU HYDRAULIQUE / HYDRAULIK MUTTERZERSTÖRER / SPACCADADI IDRAULICO / PARTE PORCAS HIDRÁULICO / ГИДРАВЛИЧЕСКИЙ РАЗРУШИТЕЛЬ ГАЕК**

Los rompetuercas de EGA Master han sido diseñados para extraer tuercas oxidadas o atoradas de manera rápida y eficaz.

Es una herramienta exclusiva con un cabezal diseñado para acceder fácilmente a la tuerca, equipada con una cuchilla de alta precisión y concebida para una vida prolongada, pudiendo ser rectificada o sustituida con rapidez.

EGA Master ofrece una gama de rompetuercas que permiten extraer tuercas hexagonales con distancia entre caras 10-41 mm.

*EGA Master's hydraulic nut splitters have been designed for removal rusted or stuck nuts quickly and effectively.*

*It is a unique tool with a head designed to access easily to the nut, equipped with a high-precision blade and designed for a long life; it can be rectified or replaced quickly.*

*EGA Master offers a range of hydraulic tools which can remove hexagonal nuts whose across flat distance is between 10 to 41 mm.*

Les casse-écrous EGA Master sont conçus pour extraire des écrous oxydés ou bouchés de manière rapide et efficace.

C'est un outil exclusif à tête conçue pour avoir accès rapide à l'écrou, équipé d'une lame de haute précision et conçu pour une durée de vie plus longue, avec la possibilité d'être changée ou substituée avec rapidité.

EGA Master offre une gamme de casse-écrous qui permet d'extraire des écrous hexagonaux dont la distance entre les faces est de 10-41 mm.

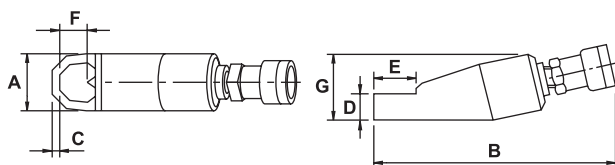

COD.	M	AF mm	TONS.	GAP cm³	A (mm)	B (mm)	C (mm)	D (mm)	E (mm)	F (mm)	G (mm)
57511	M6-M12	10-19	5	15	45	190	10	20	32	20	55
57512	M12-M16	19-24	10	20	52	214	10	26	40	27	65
57513	M16-M22	24-32	15	60	62	240	13	30	55	36	80
57514	M22-M27	32-41	20	80	73	268	17	36	67	44	90

G12

**ESPECIFICACIONES TÉCNICAS / TECHNICAL SPECIFICATION / DÉTAILS TECHNIQUES**

Peso con aceite / Weight with oil / Poids avec huile

57511 1,5 Kg

57512 2 kg

57513 3 Kg

57514 4,5 Kg

Válvula de seguridad interna / Internal safety valve / Valve de sécurité interne

•

Cilindro de retroceso con resorte / Spring return cylinder / Cylindre de recul avec ressort

•

No utilizar con tuercas cuadradas / Not to be used on square nuts / Ne pas utiliser avec des écrous carrés

•

Máxima dureza a cortar / Maximum hardness to split / Dureté max de coupe

44 HRC

Máxima presión de trabajo / Maximum operating pressure / Pression max de travail

700 bar / 10,000 psi



**EGA Master**  
 ART IN INNOVATION



## SEPARADOR DE BRIDAS HIDRÁULICO / HYDRAULIC FLANGE SPREADERS / SÉPARATEUR DE BRIDES HYDRAULIQUE / HYDRAULIK FLANSCHSPREIZER / SEPARATORE DI FASCETTE IDRAULICO / SEPARADOR DE FLANGES HIDRÁULICO / ГИДРАВЛИЧЕСКИЙ РАЗБРАСЫВАТЕЛЬ ФЛАНЦА

Los separadores hidráulicos de EGA Master han sido diseñados para facilitar al operario el mantenimiento de las bridas de las tuberías de forma segura.

Gracias a la cuña de separación, los separadores hidráulicos de EGA Master tienen una fuerza de separación de hasta 14 toneladas, con cilindro compacto, proporcionando una apertura suave y uniforme de la brida.

EGA Master's hydraulic flange spreaders have been designed to provide securely the pipe flange maintenance to the operator.



Thanks to the spreaders wedge, EGA Master's hydraulic flange spreaders have a spreading force up to 14 tons, with compact cylinder providing a soft and uniform opening flange.

Les séparateurs hydrauliques EGA Master sont conçus pour faciliter à l'ouvrier la maintenance des brides de tubes de manière sûre.

Grâce au coin de séparation, les séparateurs hydrauliques EGA Master ont une force de séparation qui arrive jusqu'à 10 tonnes, avec cylindre compacte, proportionnant une ouverture de la bride douce et uniforme.

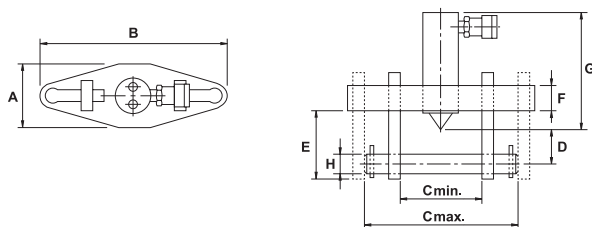
## CON PASADOR / WITH STUD / AVEC GOUPILLE / MIT STIFT / CON PERNO / COM PASSADOR / С ЗАКЛЁПКОЙ



COD.			TONS.	A (mm)	B (mm)	C min. (mm)	C max. (mm)	D (mm)	E (mm)	F (mm)	G (mm)	H (mm)	
57506	2 x 57	3-34	5	75	210	60	150	30	90	25	155	18	200
57507	2 x 85	3-43	10	110	280	105	210	45	115	38	205	27	

G12



### ESPECIFICACIONES TÉCNICAS / TECHNICAL SPECIFICATION / DÉTAILS TECHNIQUES

Peso con aceite / Weight with oil / Poids avec huile	57506 5 Kg 57507 12 Kg
Tamaño del pasador / Stud size / Dimensions de la goupille	57506 18 mm 57507 27 mm
Carrera / Stroke / Parcours	57506 38 mm 57507 54 mm
Válvula de seguridad interna / Internal safety valve / Valve de sécurité interne	●
Cilindro de retroceso con resorte / Spring return cylinder / Cylindre de recul avec ressort	●
Máxima presión de trabajo / Maximum operating pressure / Pression max de travail	700 bar / 10,000 psi

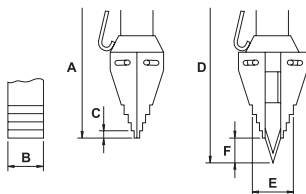

## ESCALONADO / STEPPED / ÉCHELONNÉ / STUFENFORMIG / SVASATORE / ESCALONADO / СТУПЕНЧАТЫЙ



COD.			TONS.		A (mm)	B (mm)	C (mm)	D (mm)	E (mm)	F (mm)
57508	6	75	14	78	290	36	15	310	54	24

G12

### ESPECIFICACIONES TÉCNICAS / TECHNICAL SPECIFICATION / DÉTAILS TECHNIQUES

Peso con aceite / Weight with oil / Poids avec huile	7,1 Kg
Bloques escalonados / Stepped blocks / Blocs échelonnés	2 pcs
Bloques de seguridad / Safety block / Bloc de sécurité	1 pc
Válvula de seguridad interna / Internal safety valve / Valve de sécurité interne	●
Cilindro de retroceso con resorte / Spring return cylinder / Cylindre de recul avec ressort	●
Máxima presión de trabajo / Maximum operating pressure / Pression max de travail	700 bar / 10,000 psi



G12 GARANTIA 12 MESES / 12 MONTHS OF WARRANTY / 12 MOIS DE GARANTIE / 12 MONATEN GARANTIE / 12 MAANDEN GARANTIE / 12 MESI DI GARANZIA / 12 МЕСЯЦЕВ ГАРАНТИЯ

**BOMBAS HIDRÁULICAS MANUALES / MANUAL HYDRAULIC PUMP / POMPES HYDRAULIQUES MANUELLES / MANUELLE HYDRAULIK PUMPE / POMPA IDRAULICA MANUALE / BOMBAS HIDRÁULICAS MANUAIS / НАСОС РУЧНОЙ ГИДРАВЛИЧЕСКИЙ**

Las bombas hidráulicas manuales de EGA Master han sido diseñadas para trabajar a una presión máxima de trabajo de 700bar, fabricadas en acero para alargar su vida útil.

Gracias a su funcionamiento de 2 velocidades (2-VELO) se consigue desplazar un mayor volumen de aceite por carrera y poseen gran capacidad de aceite útil en el depósito para accionar una amplia gama de herramientas de simple efecto. Además, las bombas hidráulicas manuales de EGA Master incorporan una válvula interna de alivio de presión para dar seguridad al operario y a la bomba en caso de sobrecargas por encima de 700 bar.

*EGA Master's manual hydraulic pumps have been designed to work to maximum working pressure of 700bar, made of steel to extend its life.*

*Thanks to its two-speed operation is achieved they move a greater volume of oil per stroke and have a lot of useful oil in the tank to power a wide range of single-acting tools. In addition, manual hydraulic pumps of EGA Master incorporate an internal safety valve to provide security of the operator and pump in case of over pressurisation above 700 bar.*

Les pompes hydrauliques manuelles EGA Master sont conçues pour travailler à une pression maximale de 700bar, faites en acier pour prolonger sa vie utile.

Grâce à son fonctionnement de 2 vitesses (2-VELO) on peut déplacer un grand volume d'huile par action ayant une grande capacité d'huile utile dans le dépôt pour actionner une large gamme d'outils d'effet simple. Outre, les pompes hydrauliques manuelles EGA Master incorporent une valve de surpression intérieure pour la sécurité de l'ouvrier et de la pompe en cas de surcharge supérieure à 700 bar.

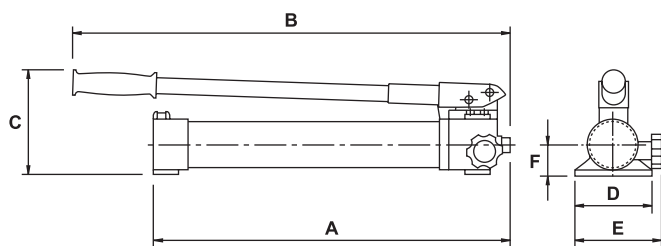

COD.	CAP. cm <sup>3</sup>	A (mm)	B (mm)	C (mm)	D (mm)	E (mm)	F (mm)
57520	700	550	650	230	140	170	55
57521	2700	600	800	250	145	170	55

G12



**ESPECIFICACIONES TÉCNICAS / TECHNICAL SPECIFICATION / DÉTAILS TECHNIQUES**

Para uso con / For use with / Pour utilisation avec	57506, 57507, 57508, 57511, 57512, 57513, 57514, 57517
Peso con aceite / Weight with oil / Poids avec huile	
	57520 10 Kg
	57521 14 Kg
Manguera hidráulica doble / Twinline Hydraulic hose / Tuyau hydraulique double	2 m
Válvula de seguridad interna / Internal safety valve / Valve de sécurité interne	●
Tipo de bomba / Bomb type / Type de pompe	2-VELO
Máxima presión de trabajo / Maximum operating pressure / Pression max de travail	700 bar / 10,000 psi
Desplazamiento del pistón por bombeo / Displacement per stroke / Déplacement du piston par pompage	
	57520 1ª Etapa: 13 cm <sup>3</sup> - 2ª Etapa: 2,2 cm <sup>3</sup>
	57521 1ª Etapa: 13 cm <sup>3</sup> - 2ª Etapa: 2,3 cm <sup>3</sup>
Fuerza máxima de bombeo / Maximum pumping force / Force maximale du pompage	35 Kg
Válvula externa de alivio / External pressure release valve / Valve de surpression externe	●

# AQUAMASTER

USO SUBACUÁTICO  
UNDERWATER USE  
UTILISATION SUBAQUATIQUE  
UNTERWASSEREINSATZ  
USO SUBACQUEO  
SUBAQUÁTICO  
ИНСТРУМЕНТ ДЛЯ ПОДВОДНЫХ РАБОТ

# 8



UNDERWATER

# AQUA Master



**EGA Master ha lanzado una completísima gama de herramientas neumáticas e hidráulicas para usos subacuáticos; amoladoras, llaves de impacto, taladros, sierras... Todas ellas están diseñadas para profesionales cuyo ámbito de trabajo habitual esté situado bajo el agua: embarcaciones hundidas, estructuras sumergidas, plataformas petrolíferas, centrales hidráulicas... Gracias a su diseño constructivo son aptas para su uso a cualquier profundidad accesible para los submarinistas.**

*EGA Master has launched a very complete range of pneumatic and hydraulic tools for underwater applications; grinders, impact wrenches, drills, saws (etc.). All of them are specially designed for professionals who usually work in underwater environment: sunk boats, submerged structures, oil rigs, hydro electric power station (etc.). Because of their design, they are suitable for being used at all depths accessible to divers.*

**EGA Master a lancéé une complète gamme d'outillage pneumatique et hydraulique pour utilisations subaquatiques; affilage, clés à frapper, perceuses, scies... Elle est conçue pour des professionnels dont le cadre de travail habituel est situé sous l'eau: embarcations coulées, structures submergées, plates-formes pétrolières et centrales hydrauliques... Grâce à son dessin constructif, elle est apte pour une utilisation dans n'importe quelle profondeur accessible pour les sous-marins.**



## Instrucciones de manejo para las herramientas subacuáticas Operating instructions for underwater tools Mode d'emploi des outils subaquatiques

### Antes de la operación subacuática:

- Comprobar que la máquina no tiene fugas.
- Comprobar todas las funciones de la máquina.
- Rociar todas las piezas móviles con el lubricante OKS 8601 (o similar).

### Después de la operación subacuática:

- Limpiar la máquina.
- Secar la máquina con aire comprimido.
- Rociar todas las piezas móviles con el lubricante OKS 8601 (o similar).

### Before underwater operation:

- Test the machine for leakage.
- Test all functions of the machine.
- Spray all moving parts with lubricant OKS 8601 (or similar).

### After underwater operation:

- Clean the machine.
- Dry the machine with compressed air.
- Spray all moving parts with lubricant OKS 8601 (or similar).

### Avant l'opération subaquatique:

- Vérifier que la machine n'a pas de fuites.
- Vérifier toutes les fonctions de la machine.
- Asperger toutes les parties mobiles avec le lubrifiant OKS 8601 (ou équivalent).

### Après l'opération subaquatique:

- Nettoyer la machine.
- Sécher la machine avec de l'air comprimé.
- Asperger toutes les pièces mobiles avec le lubrifiant OKS 8601 (ou équivalent).



## AQUAMaster

### ■ AMOLADORAS / GRINDERS / MEULEUSES / SCHLEIFMASCHINEN / SMERIGLIATRICI / REBARBADORAS / УГЛОВЫЕ ШЛИФОВАЛЬНЫЕ МАШИНКИ

Las amoladoras son herramientas muy versátiles, utilizadas en el sector del metal y la construcción para trabajar con diferentes materiales (acero, hormigón, piedra, madera, ...). Dependiendo de la herramienta de inserción escogida, podremos realizar diversos trabajos como por ejemplo; pulir, lijar, rebarbar, tronzar, devastar...

Grinders are very versatile tools, used in metal industry and construction, to work with different materials (steel, concrete, stone, wood, ...). Different insertion tools, can do different jobs such as, grinding, sanding, deburring and cutting.

Les meuleuses sont des outils versatils, utilisés dans le secteur métallier et la construction pour différents matériaux (acier, béton, bois, pierre, ...). Suivant le disque choisi, nous pourrions polir, lisser, raboter, couper, dévaster...

### ■ NEUMÁTICO / PNEUMATIC / PNEUMATIQUE / PNEUMATIK / PNEUMATICA / PNEUMÁTICO / ПНЕВМАТИЧЕСКИЕ

#### AMOLADORA ANGULAR / ANGLE GRINDER / MEULEUSE ANGULAIRE / WINKELSCHLEIFER / SMERIGLIATRICE ANGOLARE / REBARBADORA ANGULAR / УГЛОВАЯ ШЛИФОВАЛЬНАЯ МАШИНКА

COD.

79900

CE | G12

#### CARACTERÍSTICAS / FEATURES / CARACTÉRISTIQUES

Accesorios no incluidos / Accessories not included / Accessoires non inclus

#### ESPECIFICACIONES TÉCNICAS / TECHNICAL SPECIFICATION / DÉTAILS TECHNIQUES

Tipo / Type / Type	Neumático / Pneumatic / Pneumatique
Presión de trabajo / Working pressure / Pression de travail	6 bar
Disco / Disk / Disque	≤ 125 mm
Rosca de montaje / Mounting thread / Filage d'assemblage	1/4"
RPM	11600
Potencia / Power / Puissance	0,3 kW
Conexión / Connection / Connexion	R 1/4"i
Manguera (Øint.) / Hose (Øint.) / Tuyau (Øint.)	≥ 10 mm
Consumo de aire / Air consumption / Consommation d'air	1 m3/min
Nivel sonoro / Sound level / Niveau sonore	88,50 db
Nivel de vibración / Vibration level / Niveau de vibration	<2.5m/s2
Peso / Weight / Poids	2,5 kg



#### AMOLADORA RECTA / AXIAL DIE GRINDER / MEULEUSE DROITE / AXIAL-SCHLEIFMASCHINE / SMERIGLIATRICE DRITTA / RECTIFICADORA / ПРЯМАЯ ШЛИФОВАЛЬНАЯ МАШИНА

COD.

79901

CE | G12

#### CARACTERÍSTICAS / FEATURES / CARACTÉRISTIQUES

Accesorios no incluidos / Accessories not included / Accessoires non inclus

#### ESPECIFICACIONES TÉCNICAS / TECHNICAL SPECIFICATION / DÉTAILS TECHNIQUES

Tipo / Type / Type	Neumático / Pneumatic / Pneumatique
Presión de trabajo / Working pressure / Pression de travail	6 bar
RPM	20000
Potencia / Power / Puissance	0,7 kW
Conexión / Connection / Connexion	R 1/4"f
Manguera (Øint.) / Hose (Øint.) / Tuyau (Øint.)	≥ 10 mm
Consumo de aire / Air consumption / Consommation d'air	0,85 m3/min
Nivel sonoro / Sound level / Niveau sonore	85,90 db
Nivel de vibración / Vibration level / Niveau de vibration	<2.5m/s2
Longitud / Length / Longueur	250 mm
Ø de pinza / Collet Ø / Ø pince	6 mm
Peso / Weight / Poids	1,4 kg



AQUA Master

■ AMOLADORAS / GRINDERS / MEULEUSES / SCHLEIFMASCHINEN / SMERIGLIATRICI / REBARBADORAS / УГЛОВЫЕ ШЛИФОВАЛЬНЫЕ МАШИНКИ

■ HIDRÁULICA / HYDRAULIC / HYDRAULIQUE / HYDRAULISCH / IDRAULICA / HIDRÁULICA / ГИДРАВЛИЧЕСКИЙ

AMOLADORA VERTICAL / VERTICAL GRINDER / MEULEUSE VERTICALE / VERTIKALSCHLEIFER / MOLATRICE VERTICALE / REBARBADORA VERTICAL / ПЛОСКОШЛИФОВАЛЬНАЯ МАШИНА

COD.

79921

CE | G12

CARACTERÍSTICAS / FEATURES / CARACTÉRISTIQUES

Accesorios no incluidos / Accessories not included / Accessoires non inclus

ESPECIFICACIONES TÉCNICAS / TECHNICAL SPECIFICATION / DÉTAILS TECHNIQUES

Tipo / Type / Type	Hidráulico / Hydraulic / Hydraulique
Presión de trabajo / Working pressure / Pression de travail	90-140 bar
Disco / Disk / Disque	≤ 230 mm
RPM	3600
Potencia / Power / Puissance	3,5 kW
Caudal hidráulico / Oil flow / Flux d'huile	20-45 l/min
Conexión / Connection / Connexion	3/4"-16UNF
Peso / Weight / Poids	5,8 kg
Conexión de disco / Disk connection / Connexion du disque	22.2/5/8-11UNC



■ AMOLADORA RECTA / AXIAL DIE GRINDER / MEULEUSE DROITE / AXIAL-SCHLEIFMASCHINE / SMERIGLIATRICE DRITTA / RECTIFICADORA / ПРЯМАЯ ШЛИФОВАЛЬНАЯ МАШИНА

COD.

79909

CE | G12

CARACTERÍSTICAS / FEATURES / CARACTÉRISTIQUES

Accesorios no incluidos / Accessories not included / Accessoires non inclus

ESPECIFICACIONES TÉCNICAS / TECHNICAL SPECIFICATION / DÉTAILS TECHNIQUES

Tipo / Type / Type	Hidráulico / Hydraulic / Hydraulique
Presión de trabajo / Working pressure / Pression de travail	105 bar
Rosca de montaje / Mounting thread / Filage d'assemblage	1/4"
RPM	10400
Potencia / Power / Puissance	1,1 kW
Caudal hidráulico / Oil flow / Flux d'huile	7,5 l/min
Conexión / Connection / Connexion	R 1/2"FF
Nivel sonoro / Sound level / Niveau sonore	90,70 db
Nivel de vibración / Vibration level / Niveau de vibration	<2.5m/s2
Longitud / Length / Longueur	270 mm
Peso / Weight / Poids	1,6 kg
Ø de pinza / Collet Ø / Ø pince	6 mm



COD.

79911

CE | G12

CARACTERÍSTICAS / FEATURES / CARACTÉRISTIQUES

Accesorios no incluidos / Accessories not included / Accessoires non inclus

ESPECIFICACIONES TÉCNICAS / TECHNICAL SPECIFICATION / DÉTAILS TECHNIQUES

Tipo / Type / Type	Hidráulico / Hydraulic / Hydraulique
Presión de trabajo / Working pressure / Pression de travail	140 bar
Disco / Disk / Disque	≤ 200 mm
RPM	7000
Potencia / Power / Puissance	1,8 kW
Caudal hidráulico / Oil flow / Flux d'huile	18-50 l/min
Conexión / Connection / Connexion	1/2"FF
Nivel sonoro / Sound level / Niveau sonore	80,6 db
Nivel de vibración / Vibration level / Niveau de vibration	<2.5m/s2
Peso / Weight / Poids	7,6 kg



G12 GARANTIA 12 MESES / 12 MONTHS OF WARRANTY / 12 MOIS DE GARANTIE / 12 MONATEN GARANTIE / 12 MAANDEN GARANTIE / 12 MESI DI GARANZIA / 12 МЕСЯЦЕВ ГАРАНТИЯ

## AQUAMaster

### ■ LLAVES DE IMPACTO / IMPACT WRENCHES / CLÉS À CHOC / SCHLAGSCHRAUBER / AVVITATORI AD IMPULSI / CHAVES DE IMPACTO / УДАРНЫЕ ГАЙКОВЕРТЫ

Las llaves de impacto se utilizan para aplicar altos pares a tornillos de todo tipo con el simple accionamiento de un gatillo. De esta manera, podremos apretar y aflojar tornillos (por muy oxidados que éstos estén) que a mano nos sería imposible. Es muy importante tener en cuenta la medida de los tornillos con los que se va a trabajar porque no todos aguantarán el par máximo que estas llaves son capaces de aplicar.

Impact wrenches are used to apply high torque to nuts of all kinds. Thus, we can tighten and loosen the nuts (even very oxidized ones) that would be impossible to do by hand. It is very important to consider which nuts we will work on, because not all of them will stand the maximum torque that these wrenches are able to apply.

Les clés à choc s'utilisent pour un serrage important de boulons, en actionnant tout simplement une gachette. De cette façon il est possible de serrer ou de desserrer des écrous oxydés. Il est important de prendre en compte le diamètre d'écrou à travailler.

### ■ NEUMÁTICO / PNEUMATIC / PNEUMATIQUE / PNEUMATIK / PNEUMATICA / PNEUMÁTICO / ПНЕВМАТИЧЕСКИЕ

COD.	
79902	
79903	

Ex CE I G12

#### CARACTERÍSTICAS / FEATURES / CARACTÉRISTIQUES

Accesorios no incluidos / Accessories not included / Accessoires non inclus

#### ESPECIFICACIONES TÉCNICAS / TECHNICAL SPECIFICATION / DÉTAILS TECHNIQUES

Tipo / Type / Type	Neumático / Pneumatic / Pneumatique
Presión de trabajo / Working pressure / Pression de travail	6 bar
Conexión (entrada/salida) / Connection (inlet/outlet) / Connexion (entrée / sortie)	R 1/2" f - R 1/2" f
Consumo de aire / Air consumption / Consommation d'air	1,4 m <sup>3</sup> /min
Manguera (Øint.) / Hose (Øint.) / Tuyau (Øint.)	13 mm
Nivel sonoro / Sound level / Niveau sonore	96 db
Nivel de vibración / Vibration level / Niveau de vibration	
	79902 6,2 m/s <sup>2</sup>
	79903 4,5 m/s <sup>2</sup>
Designación ATEX / ATEX marking / Marquage ATEX	Ⓜ I 2 G c T6
Peso / Weight / Poids	
	79902 5,6 kg
	79903 5,5 kg
Cuadrado conductor / Square drive / Carré conducteur	
	79902 3/4"
	79903 1"
Par máx. / Torque max. / Paire max.	1350 Nm
Para pernos y tuercas / For bolts and nuts / Pour boulons et écrous	≤ M30 (46 mm AF)



Vasos de impacto - Cuadrado 3/4" y 1" - Ver capítulo de Llaves de vaso.  
 Impact socket wrenches - 3/4" and 1" Sq. Drive - See Socket wrenches chapter.  
 Douilles à choc - Carrée de 3/4" et 1" - Voir chapitre Douilles.

G12 GARANTIA 12 MESES / 12 MONTHS OF WARRANTY / 12 MOIS DE GARANTIE / 12 MONATEN GARANTIE / 12 MAANDEN GARANTIE / 12 MESI DI GARANZIA / 12 МЕСЯЦЕВ ГАРАНТИЯ

**AQUA**Master

■ **LLAVES DE IMPACTO / IMPACT WRENCHES / CLÉS À CHOC / SCHLAGSCHRAUBER / AVVITATORI AD IMPULSI / CHAVES DE IMPACTO / УДАРНЫЕ ГАЙКОВЕРТЫ**

■ **HIDRÁULICA / HIDRAULIC / HYDRAULIQUE / HYDRAULISCH / IDRAULICA / HIDRÁULICA / ГИДРАВЛИЧЕСКИЙ**

COD.	
<b>79917</b>	
<b>79918</b>	
	

**CARACTERÍSTICAS / FEATURES / CARACTÉRISTIQUES**

Accesorios no incluidos / Accessories not included / Accessoires non inclus

**ESPECIFICACIONES TÉCNICAS / TECHNICAL SPECIFICATION / DÉTAILS TECHNIQUES**

Tipo / Type / Type	Hidráulico / Hydraulic / Hydraulique
Presión de trabajo / Working pressure / Pression de travail	70-140 bar
Caudal hidráulico / Oil flow / Flux d'huile	20-40 l/min
Conexión / Connection / Connexion	M18 x 1,5
Manguera (Øint.) / Hose (Øint.) / Tuyau (Øint.)	12 mm
Nivel sonoro / Sound level / Niveau sonore	85,3 db
Nivel de vibración / Vibration level / Niveau de vibration	3,8 m/s <sup>2</sup>
Longitud / Length / Longueur	245 mm
Designación ATEX / ATEX marking / Marquage ATEX	⊕ I 2 G c T5
Peso / Weight / Poids	7,3 kg
Cuadrado conductor / Square drive / Carré conducteur	
	<b>79917</b> 3/4"
	<b>79918</b> 1"
Par máx. / Torque max. / Paire max.	1700 Nm
Para pernos y tuercas / For bolts and nuts / Pour boulons et écrous	<= M30 (46mm AF)



COD.	
<b>79919</b>	
	

**CARACTERÍSTICAS / FEATURES / CARACTÉRISTIQUES**

Accesorios no incluidos / Accessories not included / Accessoires non inclus

**ESPECIFICACIONES TÉCNICAS / TECHNICAL SPECIFICATION / DÉTAILS TECHNIQUES**

Tipo / Type / Type	Hidráulico / Hydraulic / Hydraulique
Presión de trabajo / Working pressure / Pression de travail	140 bar
Par / Torque / Paire	2500 Nm
Caudal hidráulico / Oil flow / Flux d'huile	25-45 l/min
Conexión / Connection / Connexion	1/2" FF
Designación ATEX / ATEX marking / Marquage ATEX	⊕ II 2 G c T5
Peso / Weight / Poids	10,7 kg
Cuadrado conductor / Square drive / Carré conducteur	1"
Para pernos y tuercas / For bolts and nuts / Pour boulons et écrous	≤ M36 (55 mm AF)



Vasos de impacto - Cuadrado 3/4" y 1" - Ver capítulo de Llaves de vaso.  
 Impact socket wrenches - 3/4" and 1" Sq. Drive - See Socket wrenches chapter.  
 Douilles à choc - Carrée de 3/4" et 1" - Voir chapitre Douilles.



## AQUA Master

### TALADROS / DRILLS / PERCEUSES / KLEINBOHRMASCHINE / TRAPANI / BERBEQUINS / ДРЕЛИ

Los taladros de uso subacuático de EGA Master son robustos, potentes y muy manejables. El usuario dispone de diferentes modelos para poder escoger el que más se adapte a sus necesidades. El taladro percutor de EGA Master está pensado para realizar taladros y perforaciones en multitud de materiales. La gran diferencia frente a un taladro normal, es la posibilidad de seleccionar un movimiento de percusión que acompañe al de rotación, facilitando enormemente la capacidad de perforación. Es imprescindible para perforar espesores muy gruesos de material de obra determinados o materiales muy duros, como el hormigón, la piedra, etc.

EGA Master's drills for underwater use are solid, powerful and very manageable. The user can choose different models that best suit his your needs. EGA Master Hammer drill is designed for drilling holes in several types of materials. The great difference from an ordinary drill, is the possibility of selecting a percussive movement that accompanies the rotation, greatly facilitating the drilling performance. This drill is essential to bore very thick or very hard materials such as concrete, stone, etc.

Les perceuses subaquatiques sont robustes, puissantes et maniables. Différents modèles sont disponibles, adaptés à chaque travail. Deux sélections sont disponibles (normale ou à percussion), pour optimiser le perçage. Elle est adaptée pour des perçages profonds, dans des matériaux très durs, comme le béton, la pierre, etc.

### NEUMÁTICO / PNEUMATIC / PNEUMATIQUE / PNEUMATIK / PNEUMATICA / PNEUMÁTICO / ПНЕВМАТИЧЕСКИЕ

COD.

79904

79905

Ex CE I G12

#### CARACTERÍSTICAS / FEATURES / CARACTÉRISTIQUES

Accesorios no incluidos / Accessories not included / Accessoires non inclus

#### ESPECIFICACIONES TÉCNICAS / TECHNICAL SPECIFICATION / DÉTAILS TECHNIQUES

Tipo / Type / Type Neumático / Pneumatic / Pneumatique

Presión de trabajo / Working pressure / Pression de travail 6 bar

Capacidad / Capacity / Capacité

79904 10 mm (acero)

79905 13 mm (acero)

RPM

79904 1550

79905 850

Potencia / Power / Puissance 0,5 kW

Conexión (entrada/salida) / Connection (inlet/outlet) / Connexion (entrée /sortie) R 1/4" f - R 3/8" f

Consumo de aire / Air consumption / Consommation d'air 0,6 m3/min

Manguera (Øint.) / Hose (Øint.) / Tuyau (Øint.) ≥ 10 mm

Nivel sonoro / Sound level / Niveau sonore 84 db

Portabrocas / Chuck / Mandrin

79904 10 mm

79905 13 mm

Nivel de vibración / Vibration level / Niveau de vibration <2,5 m/s2

Longitud / Length / Longueur

79904 235 mm

79905 245 mm

Designación ATEX / ATEX marking / Marquage ATEX Ⓜ I 2 G c T6

Peso / Weight / Poids 2,1 kg



**AQUA**Master

■ **TALADROS / DRILLS / PERCEUSES / KLEINBOHRMASCHINE / TRAPANI / BERBEQUINS / ДРЕЛИ**

■ **NEUMÁTICO / PNEUMATIC / PNEUMATIQUE / PNEUMATIK / PNEUMATICA / PNEUMÁTICO / ПНЕВМАТИЧЕСКИЕ**

■ **TALADRO CON PERCUSIÓN / IMPACT DRILL / PERCEUSE À PERCUSSION / SCHLAGBOHRMASCHINE / TRAPANO A PERCUSSIONE / BERBEQUIM DE PERCUSSÃO / УДАРНАЯ ДРЕЛЬ**

COD.	
<b>79906</b>	
Ex CE I G12	
<b>CARACTERÍSTICAS / FEATURES / CARACTÉRISTIQUES</b>	
Accesorios no incluidos / <i>Accessories not included</i> / Accessoires non inclus	
<b>ESPECIFICACIONES TÉCNICAS / TECHNICAL SPECIFICATION / DÉTAILS TECHNIQUES</b>	
Tipo / <i>Type</i> / Type	Neumático / <i>Pneumatic</i> / Pneumatique
Presión de trabajo / <i>Working pressure</i> / Pression de travail	6 bar
Capacidad / <i>Capacity</i> / Capacité	13 mm (acero) - 20 mm (hormigón) / 13 mm (steel) - 20 mm (concrete) / 13 mm (acier) - 20 mm (béton)
RPM	950
Potencia / <i>Power</i> / Puissance	0,5 kW
Conexión (entrada/salida) / <i>Connection (inlet/outlet)</i> / Connexion (entrée/sortie)	R 1/4" f - R 3/8" f
Consumo de aire / <i>Air consumption</i> / Consommation d'air	0,6 m <sup>3</sup> /min
Manguera (Øint.) / <i>Hose (Øint.)</i> / Tuyau (Øint.)	≥ 10 mm
Nivel sonoro / <i>Sound level</i> / Niveau sonore	84 db
Portabrocas / <i>Chuck</i> / Mandrin	13 mm
Nivel de vibración / <i>Vibration level</i> / Niveau de vibration	<2,5 m/s <sup>2</sup>
Longitud / <i>Length</i> / Longueur	300 mm
Designación ATEX / <i>ATEX marking</i> / Marquage ATEX	Ⓢ II 2 G c T6
Peso / <i>Weight</i> / Poids	3,3 kg



COD.	
<b>79907</b>	
Ex CE I G12	
<b>CARACTERÍSTICAS / FEATURES / CARACTÉRISTIQUES</b>	
Accesorios no incluidos / <i>Accessories not included</i> / Accessoires non inclus	
<b>ESPECIFICACIONES TÉCNICAS / TECHNICAL SPECIFICATION / DÉTAILS TECHNIQUES</b>	
Tipo / <i>Type</i> / Type	Neumático / <i>Pneumatic</i> / Pneumatique
Presión de trabajo / <i>Working pressure</i> / Pression de travail	6 bar
Impactos por minuto / <i>Impacts per minute</i> / Impacts par minute	3000
Capacidad / <i>Capacity</i> / Capacité	28 mm (hormigón) / 28 mm (concrete) / 28 mm (béton)
RPM	625
Potencia / <i>Power</i> / Puissance	0,5 kW
Conexión (entrada/salida) / <i>Connection (inlet/outlet)</i> / Connexion (entrée/sortie)	R 1/2" f - R 3/8" f
Consumo de aire / <i>Air consumption</i> / Consommation d'air	0,6 m <sup>3</sup> /min
Manguera (Øint.) / <i>Hose (Øint.)</i> / Tuyau (Øint.)	≥ 10 mm
Nivel sonoro / <i>Sound level</i> / Niveau sonore	93 db
Adaptador / <i>Adapter plug</i> / Adaptateur	SDS-plus®
Nivel de vibración / <i>Vibration level</i> / Niveau de vibration	4,5 m/s <sup>2</sup>
Longitud / <i>Length</i> / Longueur	400 mm
Designación ATEX / <i>ATEX marking</i> / Marquage ATEX	Ⓢ II 2 G c T6
Peso / <i>Weight</i> / Poids	6,3 kg



08

USO SUBACUÁTICO  
 UNDERWATER USE  
 UTILISATION SUBAQUATIQUE  
 UNTERWASSEREINSATZ  
 UTENSILI IDRAULICI E PNEUMATICI PER USO SUBACQUEO  
 SUBAQUÁTICO  
 ИНСТРУМЕНТ ДЛЯ ПОДВОДНЫХ РАБОТ



AQUA Master

■ TALADROS / DRILLS / PERCEUSES / KLEINBOHRMASCHINE / TRAPANI / BERBEQUINS / ДРЕЛИ

■ NEUMÁTICO / PNEUMATIC / PNEUMATIQUE / PNEUMATIK / PNEUMATICA / PNEUMÁTICO / ПНЕВМАТИЧЕСКИЕ

■ TALADRO CON PERCUSIÓN / IMPACT DRILL / PERCEUSE À PERCUSSION / SCHLAGBOHRMASCHINE / TRAPANO A PERCUSSIONE / BERBEQUIM DE PERCUSSÃO / УДАРНАЯ ДРЕЛЬ

COD.

79908

Ex CE I G12

CARACTERÍSTICAS / FEATURES / CARACTÉRISTIQUES

Accesorios no incluidos / Accessories not included / Accessoires non inclus

ESPECIFICACIONES TÉCNICAS / TECHNICAL SPECIFICATION / DÉTAILS TECHNIQUES

Tipo / Type / Type	Neumático / Pneumatic / Pneumatique
Presión de trabajo / Working pressure / Pression de travail	6 bar
Impactos por minuto / Impacts per minute / Impacts par minute	2500
Capacidad / Capacity / Capacité	50 mm (hormigón) - 80 mm (mampostería) / 50 mm (concrete) - 80 mm (masonry) / 50 mm (béton) - 80 mm (maçonnerie)
RPM	250
Potencia / Power / Puissance	1,5 kW
Conexión (entrada/salida) / Connection (inlet/outlet) / Connexion (entrée /sortie)	R 1/2" f - R 3/8" f
Consumo de aire / Air consumption / Consommation d'air	1,5 m <sup>3</sup> /min
Manguera (Øint.) / Hose (Øint.) / Tuyau (Øint.)	≥ 13 mm
Nivel sonoro / Sound level / Niveau sonore	90,4 db
Portabrocas / Chuck / Mandrin	SDS-max
Nivel de vibración / Vibration level / Niveau de vibration	9,2 m/s <sup>2</sup>
Longitud / Length / Longueur	640 mm
Designación ATEX / ATEX marking / Marquage ATEX	⊕ II 2 G c T6
Peso / Weight / Poids	13,3 kg



■ TALADROS / DRILLS / PERCEUSES / KLEINBOHRMASCHINE / TRAPANI / BERBEQUINS / ДРЕЛИ

■ HIDRÁULICA / HYDRAULIC / HYDRAULIQUE / HYDRAULISCH / IDRAULICA / HIDRÁULICA / ГИДРАВЛИЧЕСКИЙ

COD.

79912

CE I G12

CARACTERÍSTICAS / FEATURES / CARACTÉRISTIQUES

Accesorios no incluidos / Accessories not included / Accessoires non inclus

ESPECIFICACIONES TÉCNICAS / TECHNICAL SPECIFICATION / DÉTAILS TECHNIQUES

Tipo / Type / Type	Hidráulico / Hydraulic / Hydraulique
Presión de trabajo / Working pressure / Pression de travail	140 bar
RPM	280
Potencia / Power / Puissance	1,6 kW
Par / Torque / Paire	60 Nm
Caudal hidráulico / Oil flow / Flux d'huile	10 l/min
Conexión / Connection / Connexion	1/2" FF
Nivel sonoro / Sound level / Niveau sonore	85,2 db
Portabrocas / Chuck / Mandrin	MT3
Nivel de vibración / Vibration level / Niveau de vibration	<15,8 m/s <sup>2</sup>
Peso / Weight / Poids	8,5 kg



G12 GARANTIA 12 MESES / 12 MONTHS OF WARRANTY / 12 MOIS DE GARANTIE / 12 MONATEN GARANTIE / 12 MAANDEN GARANTIE / 12 MESI DI GARANZIA / 12 МЕСЯЦЕВ ГАРАНТИЯ

Si no encuentra el artículo que necesita, consúltenos en [info@egamaster.com](mailto:info@egamaster.com) o en [www.egamaster.com](http://www.egamaster.com)  
 If you can't find the item you look for, please ask us in [info@egamaster.com](mailto:info@egamaster.com) or in [www.egamaster.com](http://www.egamaster.com)  
 Si vous ne trouvez pas l'article que vous désirez, consultez-nous à [info@egamaster.com](mailto:info@egamaster.com) ou à [www.egamaster.com](http://www.egamaster.com)

EGA Master  
 ART IN INNOVATION

353

AQUA Master

■ TALADROS / DRILLS / PERCEUSES / KLEINBOHRMASCHINE / TRAPANI / BERBEQUINS / ДРЕЛИ

■ HIDRÁULICA / HIDRAULIC / HYDRAULIQUE / HYDRAULISCH / IDRAULICA / HIDRÁULICA / ГИДРАВЛИЧЕСКИЙ

■ TALADRO CON PERCUSIÓN / IMPACT DRILL / PERCEUSE À PERCUSSION / SCHLAGBOHRMASCHINE / TRAPANO A PERCUSSIONE / BERBEQUIM DE PERCUSSÃO / УДАРНАЯ ДРЕЛЬ

COD.	
79915	
CE Ex I G12	
CARACTERÍSTICAS / FEATURES / CARACTÉRISTIQUES	
Accesorios no incluidos / Accessories not included / Accessoires non inclus	
ESPECIFICACIONES TÉCNICAS / TECHNICAL SPECIFICATION / DÉTAILS TECHNIQUES	
Tipo / Type / Type	Hidráulico / Hydraulic / Hydraulique
Presión de trabajo / Working pressure / Pression de travail	80 bar
Impactos por minuto / Impacts per minute / Impacts par minute	3400
Capacidad / Capacity / Capacité	28 mm (hormigón) - 50 mm (mampostería) / 28 mm (hormigón) - 50 mm (mampostería) / 28 mm (béton) - 50 mm (maçonnerie)
RPM	500
Potencia / Power / Puissance	1,2 kW
Caudal hidráulico / Oil flow / Flux d'huile	15-45 l/min
Conexión / Connection / Connexion	3/4"-16UNF
Nivel sonoro / Sound level / Niveau sonore	92 db
Adaptador / Adapter plug / Adaptateur	SDS-plus®
Nivel de vibración / Vibration level / Niveau de vibration	4,5 m/s <sup>2</sup>
Longitud / Length / Longueur	460 mm
Designación ATEX / ATEX marking / Marquage ATEX	Ⓢ II 2 G c T5
Peso / Weight / Poids	8,2 kg



COD.	
79916	
CE Ex I G12	
CARACTERÍSTICAS / FEATURES / CARACTÉRISTIQUES	
Accesorios no incluidos / Accessories not included / Accessoires non inclus	
ESPECIFICACIONES TÉCNICAS / TECHNICAL SPECIFICATION / DÉTAILS TECHNIQUES	
Tipo / Type / Type	Hidráulico / Hydraulic / Hydraulique
Presión de trabajo / Working pressure / Pression de travail	80 bar
Impactos por minuto / Impacts per minute / Impacts par minute	2300
Capacidad / Capacity / Capacité	50 mm (hormigón) - 80 mm (mampostería) / 50 mm (concrete) - 80 mm (masonry) / 50 mm (béton) - 80 mm (maçonnerie)
RPM	270
Potencia / Power / Puissance	1,2 kW
Caudal hidráulico / Oil flow / Flux d'huile	15-45 l/min
Conexión / Connection / Connexion	3/4"-16UNF
Nivel sonoro / Sound level / Niveau sonore	92 db
Adaptador / Adapter plug / Adaptateur	SDS-max
Nivel de vibración / Vibration level / Niveau de vibration	9 m/s <sup>2</sup>
Longitud / Length / Longueur	640 mm
Designación ATEX / ATEX marking / Marquage ATEX	Ⓢ II 2 G c T5
Peso / Weight / Poids	14 kg



## AQUA Master

### SIERRAS PORTÁTILES / RECIPROCATING SAWS / SCIES PORTABLES / STICHSÄGE / SEGHETTI PORTATILI / SERRAS PORTÁTEIS / ПИЛЫ ВОЗВРАТНО-ПОСТУПАТЕЛЬНОГО ДЕЙСТВИЯ

Las sierras portátiles son herramientas necesarias para poder realizar todo tipo de cortes; cortes cruzados, rectos, cortes curvos, cortes en pico, biselados, etc. Destacan las sierras sable también conocidas como sierras de vaivén, que como bien dice su nombre, aprovechan el movimiento de vaivén de su cuchilla para facilitar la realización de cortes.

Reciprocating saws are necessary tools to perform all types of cutting: cross cut, straight, curved cuts, cuts in peak, beveled, etc.. It is worth highlighting saber saws also known as jigsaws, wich use the swinging motion of its blade to make cuts easier.

Les scies portables sont adaptées pour des coupes; coupes croisées, droites, courbes, biseautées, etc. . . Il y a aussi les scies sabres, avec un mouvement de va et vient, pour faciliter la coupe.

### HIDRÁULICA / HIDRAULIC / HYDRAULIQUE / HYDRAULISCH / IDRAULICA / HIDRÁULICA / ГИДРАВЛИЧЕСКИЙ

COD.

79913

Ex CE I G12

#### CARACTERÍSTICAS / FEATURES / CARACTÉRISTIQUES

Accesorios no incluidos / Accessories not included / Accessoires non inclus

#### ESPECIFICACIONES TÉCNICAS / TECHNICAL SPECIFICATION / DÉTAILS TECHNIQUES

Tipo / Type / Type	Hidráulico / Hydraulic / Hydraulique
Presión de trabajo / Working pressure / Pression de travail	140 bar
Tipo de válvula / Valve type / Type de valve	Twist
Carrera / Stroke / Parcours	60 mm
N.º de golpes / Number of strokes / Nro. de coups	500 rpm
Potencia / Power / Puissance	2,8 kW
Caudal hidráulico / Oil flow / Flux d'huile	10-50 l/min
Conexión / Connection / Connexion	12S
Manguera (Øint.) / Hose (Øint.) / Tuyau (Øint.)	12 mm
Nivel sonoro / Sound level / Niveau sonore	86 db
Nivel de vibración / Vibration level / Niveau de vibration	<2,5 m/s2
Designación ATEX / ATEX marking / Marquage ATEX	Ⓢ II 2 G c T5
Peso / Weight / Poids	6,1 kg



### SIERRA SABLE / SABRE SAW / SCIE SABRE / SÄBELSÄGE / SEGHETTO ALTERNATIVO / SERRA DE SABRE / САБЕЛЬНАЯ ПИЛА

COD.

79914

Ex CE I G12

#### CARACTERÍSTICAS / FEATURES / CARACTÉRISTIQUES

Accesorios no incluidos / Accessories not included / Accessoires non inclus

#### ESPECIFICACIONES TÉCNICAS / TECHNICAL SPECIFICATION / DÉTAILS TECHNIQUES

Tipo / Type / Type	Hidráulico / Hydraulic / Hydraulique
Presión de trabajo / Working pressure / Pression de travail	140 bar
Tipo de válvula / Valve type / Type de valve	Trigger
Carrera / Stroke / Parcours	28 mm
N.º de golpes / Number of strokes / Nro. de coups	1500 rpm
Potencia / Power / Puissance	1,5 kW
Caudal hidráulico / Oil flow / Flux d'huile	22-50 l/min
Conexión / Connection / Connexion	1/2" FF
Nivel sonoro / Sound level / Niveau sonore	89,4 db
Nivel de vibración / Vibration level / Niveau de vibration	<2,5 m/s2
Designación ATEX / ATEX marking / Marquage ATEX	Ⓢ II 2 G c T5
Peso / Weight / Poids	6 kg
Capacidad de corte / Cutting capacity / Capacité de coupe	Madera: 160 mm - Acero: 19 mm / Wood: 160 mm - Steel: 19 mm / Bois: 160 mm - Acier: 19 mm



## AQUA Master

### ■ PERFORADORA / CORE DRILL / CAROTTEUSE À BETON / BOHRHAMMER / PERFORATORE / PERFURADORA / ДРЕЛЬ АЛМАЗНОГО БУРЕНИЯ

Las perforadoras de EGA Master son máquinas portátiles hidráulicas para hacer perforaciones en superficies de muy diversos materiales; piedra, ladrillo, hormigón, bloque... Dispone de tres velocidades de perforación y su capacidad máxima es de 160mm.

EGA Master's core drills are portable hydraulic machines that drill the surfaces made of very different materials such as stone, brick, concrete, block... They have three drilling speeds and maximum capacity of 160 mm.

Les perceurs d'EGA Master sont des machines hydrauliques portatives, pour toutes sortes de matériaux. Elles ont trois vitesses de perforation et la capacité max est de 160 mm.

### ■ HIDRÁULICA / HIDRAULIC / HYDRAULIQUE / HYDRAULISCH / IDRAULICA / HIDRÁULICA / ГИДРАВЛИЧЕСКИЙ

N/

COD.

79920

Ex CE I G12

#### CARACTERÍSTICAS / FEATURES / CARACTÉRISTIQUES

Accesorios no incluidos / Accessories not included / Accessoires non inclus

#### ESPECIFICACIONES TÉCNICAS / TECHNICAL SPECIFICATION / DÉTAILS TECHNIQUES

Tipo / Type / Type	Hidráulico / Hydraulic / Hydraulique
Presión de trabajo / Working pressure / Pression de travail	140 bar
RPM	380-900-1800
Potencia / Power / Puissance	2,8 kW
Par / Torque / Paire	60/38/17 Nm
Caudal hidráulico / Oil flow / Flux d'huile	22-45 l/min
Conexión / Connection / Connexion	1/2"FF
Brocas standard / Standard drills / Mèche standard	≤160 mm
Longitud / Length / Longueur	490 mm
Designación ATEX / ATEX marking / Marquage ATEX	Ⓢ II 2G c T5
Peso / Weight / Poids	8,5 kg



### ■ LINTERNA / TORCH / LAMPE / TASCHENLAMP / TORCIA / LANTERNA / ФОНАРЬ

#### ■ MASTEREX 79598

La linterna MasterEx 79598 ofrece una autonomía de 13 horas con sus 4 pilas alcalinas AA y está equipada con un LED de potencia 1W.

Su ligereza, ergonomía y su grado de protección IP68 la convierten en una linterna perfecta para su uso tanto en ambientes de gas explosivos peligrosos, hasta zona 0, como para uso subacuático.

*The MasterEx 79598 LED torch offers 13 hours of continuous work with 4 AA alkaline batteries and is equipped with a 1W power LED.*

*Its light, ergonomics and IP68 protection grade makes it a perfect torch for use both in hazardous gas areas, up to Zone 0, and for underwater use.*

La lampe LED MasterEx 79598 offre une autonomie de 13 heures avec ses 4 piles alcalines AA et elle est composée par un LED de puissance 1W.

Sa légèreté, ergonomie et degré de protection IP68, la transforment en lampe parfaite pour utiliser dans les environnements de gaz explosifs dangereux, jusqu'à la Zone 0, comme pour utilisation subaquatique.

COD.

79598

Ex I G12

#### ESPECIFICACIONES TÉCNICAS / TECHNICAL SPECIFICATION / DÉTAILS TECHNIQUES

Fuente de luz / Light source / Source de lumière	Osram 1 W Led
Luminosidad / Brightness / Luminosité	60 Lúmenes / 60 Lumens / 60 Lumens
Alimentación / Power supply / Alimentation	4 x AA pilas (certificadas) / 4 x AA batteries (type tested) / 4 x AA piles (certifiées)
Clase de protección / Protection class / Classe de protection	IP68
Designación ATEX / ATEX marking / Marquage ATEX	Ⓢ II 1 G Ex ia IIC T4 ia D 20 T135°C
Inmersión continua / Continuous immersion / Immersion continue	●
Baterías incluidas / Included batteries / Piles incluses	●
Longitud / Length / Longueur	175 mm
Peso / Weight / Poids	96 g



# TITANIUM

ANTI-MAGNÉTICA DE TITANIO  
NON-MAGNETIC TITANIUM  
AMAGNETIQUE EN TITANE  
TITAN NICHT MAGNETISCH  
ANTIMAGNETICO AL TITANIO  
ANTI-MAGNÉTICO DE TITÂNEO  
НЕМАГНИТНЫЙ ТИТАНОВЫЙ

# 9

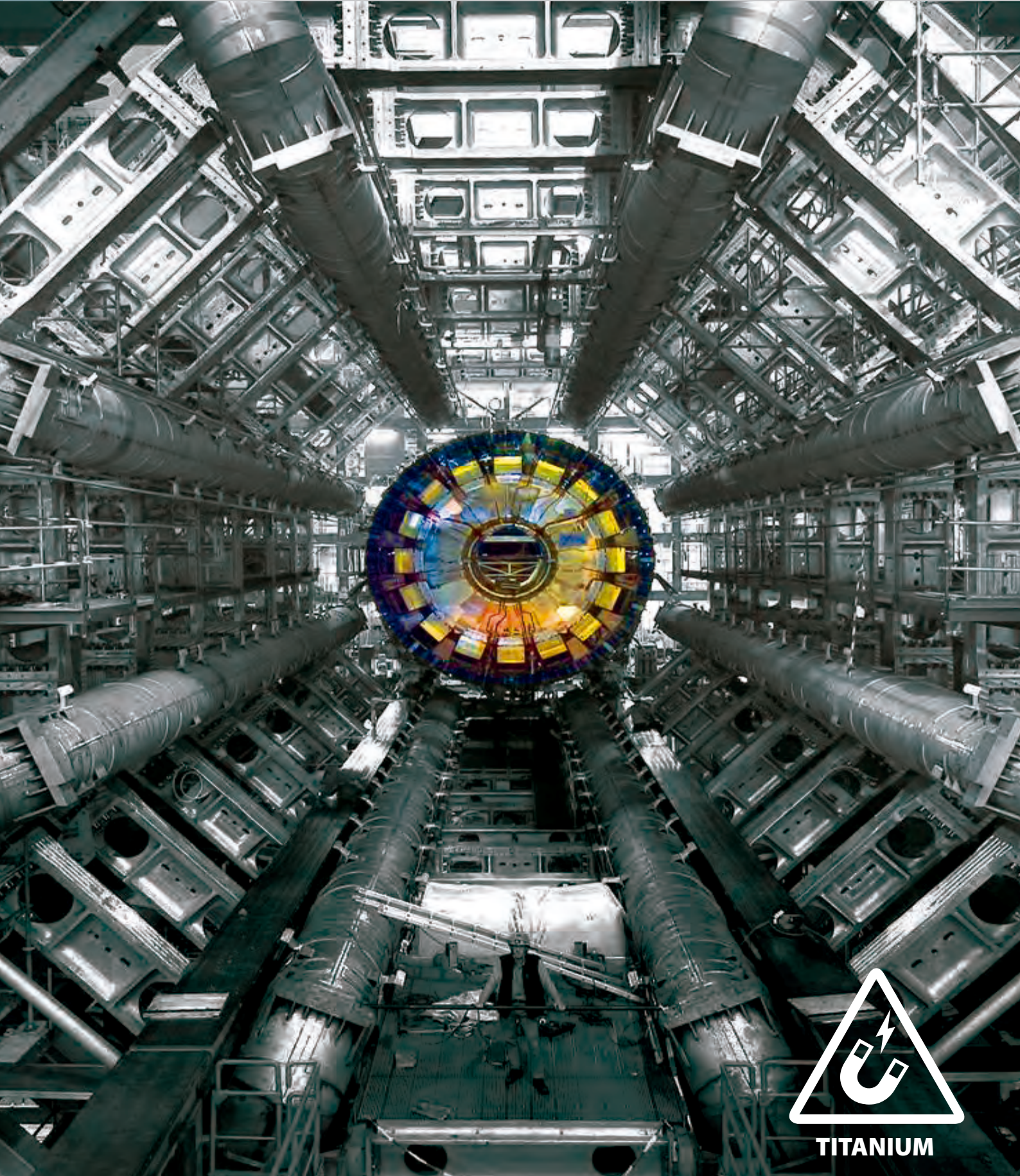

TITANIUM

Las herramientas de Titanio EGA Master han sido desarrolladas con la más alta tecnología y fabricadas en aleación de Titanio 6Al-4V, para ser usadas en los más exigentes y avanzados campos, tales como la aviación, equipos hospitalarios, aplicaciones aeroespaciales y militares. Estas propiedades hacen que esta aleación sea la mejor que actualmente existe para aplicaciones críticas y especiales que requieren una gran capacidad mecánica, combinada con características que otra aleación no puede conseguir, como la de ser no-magnética, etc. Muchas aplicaciones requieren herramientas completamente no magnéticas para no causar ninguna alteración, por ejemplo dispositivos muy sensibles usados en laboratorios, hospitales, centros de transformación, estaciones de radar, antenas etc.

*EGA Master Titanium Tools have been developed with the help of the most advanced technology. They are manufactured with Titanium alloy, 6Al-4V, which has been used in the most innovative and advanced fields, such as aviation, military and aerospace applications. Its properties make this alloy the best one among the current existing ones for special and critical applications that require high mechanical properties, combined together with features that no other steel alloy tool can reach, like Non-Magnetism. Many applications require the use of totally non-magnetic tools in order to avoid any magnetic disturbance, such as very sensitive electronic devices used in laboratories, hospitals, power plants, etc.*

L'outillage en Titane d'EGA Master a été développé avec la plus haute technologie, alliage de Titane 6Al-4V, utilisé dans les domaines les plus avancés et les plus techniques comme l'aviation, l'industrie militaire et les applications aérospaciales. Les propriétés du Titane font de cet alliage, le meilleur pour des applications critiques et spéciales qui requièrent une grande résistance mécanique, combinée avec d'autres caractéristiques que d'autres alliages de fer n'ont pas, comme l'amagnétisme. Beaucoup d'applications nécessitent des caractéristiques totalement amagnétiques, pour ne pas causer d'altération magnétique, par exemple, avec des dispositifs très sensibles utilisés dans les laboratoires, les hopitaux et les centres de transformation...

Propiedades Properties Propriétés	Aplicación y beneficios Application & benefits Applications
100 % seguridad de anti- magnetismo <i>100% non-magnetic safety</i> 100% sécurité anti-magnétique	Esencial para equipos que requieren una completa seguridad no magnética <i>Essential for equipments that require complete non-magnetic safety, avoiding magnetic disturbance</i> Essentiel pour des équipements nécessitant de l'outillage amagnétique
Inoxidable (más que el acero inoxidable) <i>Rustproof (more than stainless steel)</i> Inoxidable (plus que l'inox)	Especialmente concebidos para aplicaciones en entornos corrosivos como pueden ser en trabajos en la marina o de aplicaciones de bomberos <i>Specially well suited for applications in corrosive environments like the ones encountered in marine works or fire-fighting applications</i> Spécialement conçu pour des lieux à fort taux de corrosion, comme des travaux marins ou des utilisations par des pompiers
Extremadamente resistente al ácido <i>Extremely Acid Resistant</i> Extremely Acid Resistant	Perfecto para la industria química, herramienta duradera <i>Perfect for Chemical Industry, long lasting tools</i> Parfait pour l'industrie chimique, outillage à longue durabilité
Hipoalergénico <i>Hypoallergenic</i> Hipoalergénique	También apropiado por el incremento diario de alergias hacia materiales como el Ni, la alergia más frecuente, presente en la mayoría de las aleaciones de acero <i>Also appropriate for the daily increasing allergies to materials such as Ni, the most frequent allergy, present on most of the steel alloys</i> Aussi approprié pour éviter les allergies, tous les jours croissants, au matériau tel que le Nickel (allergie la plus fréquente), présent dans les alliages d'acier
45 % más ligero que el acero <i>45% lighter than steel</i> 45% plus léger que l'acier	Evita las modernas y frecuentes lesiones causadas por movimientos de carga, como pueden ser la tendinitis o bursitis <i>Avoids modern and frequent injuries caused by repetitive load movements, such as tendinitis or bursitis</i> Fait éviter les lésions fréquentes du monde moderne telles que les tendinites, dues à la manipulation de poids

MAT.: Ti 6Al-4V	
Composición Composition Composition	V 3,5 % - 4,5 %
	Al 5,5 % - 6,8 %
	Otros / Others / Autres <1 %
Dureza / Hardness / Dureté	30-40 HRC
Temperatura de fusión Melting Temperatura Temperature de fusion	1650 °C
Resistencia a la tracción Tensile Strength Resistance à la traction	993 N/mm <sup>2</sup>





■ **PRINCIPALES CAMPOS DE APLICACIÓN**  
**MAIN APPLICATION FIELDS**  
**PRINCIPAUX CHAMPS D'APPLICATION**

<b>Propiedad antimagnética</b> <i>Non-magnetic property</i> <b>Propriété antimagnétique</b>	<b>Inoxidable y resistente al ácido</b> <i>Rustproof and acid resistant properties</i> <b>Inoxidable et résistant à l'acide</b>
Marina / Navy / Marine	Trabajos al exterior / <i>Outdoor works</i> / Travaux extérieurs
Servicios de reparación de Electrónica y dispositivos Eléctricos <i>Electronic and Electric device repairing services</i> Services de réparation Electronique et dispositifs électriques	Construcciones de Diques / <i>Dock constructions</i> / Construction de docks
Fabricantes de Electrónica y dispositivos Eléctricos <i>Electronic and Electric device manufacturers</i> Fabricants d'électronique et de dispositifs électriques	Aplicaciones sub-acuáticas / <i>Scuba Diving applications</i> Applications Sous-marines
Estaciones de servicio y energía / <i>Power stations</i> Stations-service et energie	Industria química / <i>Chemical Industry</i> / Industrie chimique
Defensa / <i>Defence</i> / Defense	Bomberos / <i>Fire-fighters</i> / Pompiers
Fuerzas aéreas / <i>Air Forces</i> / Forces aériennes	Instalaciones de desalinización de aguas <i>Water De-salination Installations</i> / Usine de désalement d'eau
Fabricante de armas / <i>Weapon fabrication</i> / Fabricants d'armes	Defensa / <i>Defence</i> / Defense
Trabajos ferroviarios / <i>Railway works</i> / Travaux ferrovières	Fuerzas aéreas / <i>Air Force</i> / Forces aériennes
Telecomunicaciones / <i>Telecommunication</i> / Telecommunications	Marina / Navy / Marine
Aplicaciones aeroespaciales / <i>Aerospace applications</i> Applications aérospaciales	Industrias farmacéuticas / <i>Pharmaceutical Industries</i> Industrie Pharmaceutique
Aviación / <i>Aviation</i> / Aviation	Construcción de barcos / <i>Ship building</i> / Construction navale
Laboratorios de alta tecnología / <i>High Tech Laboratories</i> Laboratoires de haute technologie	Plataformas exteriores de Gas y petróleo / <i>Offshore oil and gas platforms</i> Plateformes extérieures de gaz et de pétrole
Hospitales (scanners, rayos X, MRI, ECG, Dispositivos desfibriladores...) <i>Hospitals (scanners, X-ray, MRI, ECG, Defibrillation devices, CRT...)</i> Hopitaux (scanners, rayons X, MRI, ECG, Dispositifs desfilibriseurs)	Industrias farmacéuticas / <i>Pharmaceutical Industries</i> Industrie pharmaceutique
Industrias nucleares / <i>Nuclear Industries</i> / Industries nucleaires	Fabricas de sal / <i>Salt Industry</i> / Usine de sel
NMR imanes, espectrómetros, grandes imanes Tesla <i>NMR Magnets, Spectrometers, High Tesla Magnets</i> NMR aimans, spectromètres, électronique à raisonnance magnétique	

■ **INSTRUCCIONES DE USO Y GARANTÍA**  
**INSTRUCTIONS FOR USE & WARRANTY**  
**INSTRUCTIONS DE GARANTIE ET D'UTILISATION**

- Las herramientas de Titanio no pueden alcanzar la dureza de las herramientas convencionales. Esto es debido al hecho de que la composición del material hace que sea imposible que sea inducida su dureza. Por esta razón, el uso de las herramientas de Titanio debe tener un especial cuidado, evitando sobreesfuerzos.  
*Titanium Tools cannot reach the hardness of conventional tools, due to the fact that the material composition makes it impossible to be induction hardened. For this reason the use of Titanium Tools has to be carried out with special care, avoiding overstraining, heating, etc.*  
L'outillage Titane ne peut pas avoir la même dureté que l'outillage traditionnel, car la composition du matériau empêche l'induction de la dureté. Pour cela, il requière une attention spéciale, en évitant la rupture, la chaleur...
- El uso de herramientas de Titanio no debe ser la única medida preventiva en áreas en las que se ha diseñado para ello. Otros objetos, como ropa o material presencial, deben ser también adecuados.  
*The use of Titanium Tools must not be the only preventive measure in areas which the items are designed for. Other items, clothes or present material must also be adequate.*  
L'utilisation d'outillage en Titane ne doit pas être le seul moyen de prévention dans les environnements pour lequel il est conçu. D'autres objets, comme les vêtements et matériaux présents doivent aussi être adaptés aux applications anti-déflagrantes.
- Las herramientas de Titanio de **EGA Master** tienen una garantía de por vida. En el caso de defecto de fabricación deberán ser reparadas o reemplazadas sin ningún coste. El uso indebido es considerado como una excepción de la garantía.  
*EGA Master Titanium Tools are provided with lifetime warranty. In case an EGA Master tool breaks or fails to perform under normal and correct use, it will be repaired or replaced free of cost. Any misuse, abuse or normal service wear is considered as an exception to the warranty.*  
L'outillage en Titane de **EGA Master** a une garantie à vie. Dans le cas d'une rupture ou en présence de vices à la livraison, l'outillage devra être réparé ou remplacé sans aucun surcoût. Une utilisation non conforme exclut la garantie.

¿Sabía usted que las herramientas de Titanio de **EGA Master** se emplean por el laboratorio CERN (Organización Europea de Investigación Nuclear) que recientemente ha encontrado el Bosón de Higgs, uno de los descubrimientos científicos más importantes de todos los tiempos? Las partículas que colisionan durante los experimentos se aceleran a velocidades cercanas a la luz usando potentísimos electro-imanés. Estos últimos requieren del empleo de herramientas completamente amagnéticas, como las herramientas de Titanio fabricadas por **EGA Master**.

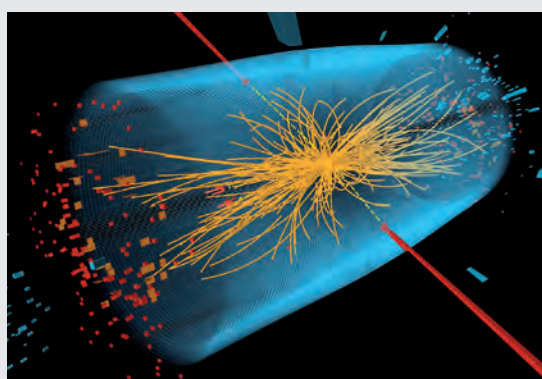
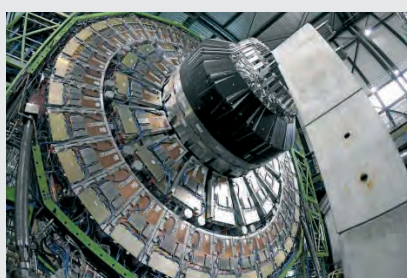
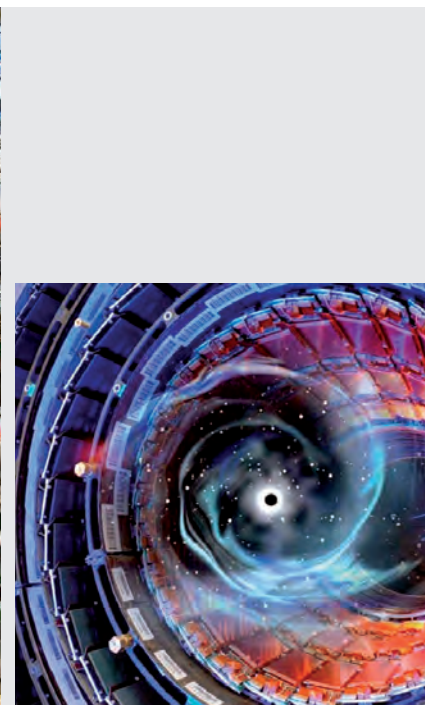
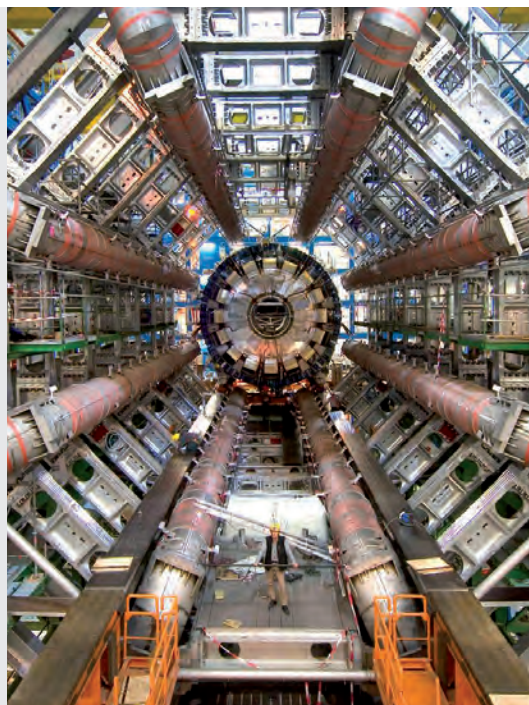

Did you know that **EGA Master** titanium tools are used by the CERN laboratory (European Organization for Nuclear Research) which has recently found the Higgs Boson, one of the greatest scientific discoveries of all times? The particles that collide during the experiments are accelerated to speeds that are close to the speed of light by using very powerful electro-magnets. Such magnets require the use of non-magnetic tools, the most non-magnetic of which are the ones made in Titanium by **EGA Master**.

Saviez vous que les outils en titane d'**EGA Master** sont utilisés par le laboratoire CERN (Organisation Européenne de Recherche Nucléaire) qui a récemment découvert le boson d'Higgs, une des découvertes scientifiques les plus importantes de tous les temps? Les particules que entrent en collision durant les expériences s'accélèrent à des vitesses proches de celle de la lumière en utilisant des électro-aimants très puissants. Ces derniers requièrent l'usage d'outils complètement amagnétiques, tels que les outils en Titane fabriqués par **EGA Master**.

■ **ALICATES / PLIERS / PINCES / ZANGEN / PINZE / ALICATES / ПЛОСКОГУБЦЫ**

■ **UNIVERSALES / COMBINATION / UNIVERSELLES / KOMBIZANGEN / UNIVERSALE / UNIVERSAIS / КОМБИНИРОВАННЫЕ**

COD.	L (mm)	
71646	160	150
71647	200	250

**BMAT** | Modelo registrado / Registered model / Modèle enregistré



■ **TELEFONISTA / LONG NOSE / TÉLÉPHONE / TELEFONZANGEN / TELEFONISTI / TELEFONISTA / СУДЛИННЕННЫМИ НОСАМИ**

COD.	L (mm)	
71648	180	100
71649	200	

**BMAT** | Modelo registrado / Registered model / Modèle enregistré



■ **CORTE DIAGONAL / DIAGONAL CUTTING PLIERS / COUPANTES DIAGONALES / KRAFTSEITENSCHNEIDER / TAGLIO LATERALE / CORTE DIAGONAL / БОКОРЕЗЫ**

COD.	L (mm)	
71650	160	100
71651	200	

**BMAT** | Modelo registrado / Registered model / Modèle enregistré



■ **ALICATE TIPO FORD / SLIP JOINT PLIER / PINCE MOTORISTE / MECHANIKERZANGE / PINCE PER GASISTI / ALICATE MOTORISTA / СКОЛЬЗЯЩИЕ КЛЕЩИ**

COD.	L (mm)	
71731	200	250



■ **ALICATES CIRCLIPS / CIRCLIPS PLIERS / PINCES CIRCLIPS / ZANGEN FÜR SICHERUNGSRINGE / PINZE PER ANELLI / ALICATES FREIOS / СЪЕМНИК КОЛЕЦ**

COD.	L (mm)		
72082	180	19-60	100



■ **ALICATES PARA TERMINALES / CRIMPING PLIERS / PINCES À SERTIR LES COSSES / KABELKLEMMZANGE / PINZA PER CAPICORDA / ALICATE PARA CRAVAR TERMINAIS / ОБЖИМНЫЕ КЛЕЩИ**

COD.	L (mm)	
71652	200	120



■ **TENAZAS / PINCERS / PINCES / ZANGE / TENAGLIE / ALICATES / КЛЕЩИ**

■ **PICO DE LORO / GROOVE JOINT / MULTIPRISE À CRÉMAILLÈRE / WASSERPUMPENZANGE / PINZE REGOLABILI / BICO DE PAPAGAIO / КЛЕЩИ ЖЕЛОБКОВОГО ТИПА**

COD.	L (mm)	
72532	250	250
72533	370	550



■ **LLAVES / WRENCHES / CLÉS / SCHLÜSSEL / CHIAVI / CHAVES / КЛЮЧИ**

■ **LLAVE COMBINADA DE CARRACA / COMBINATION RATCHET WRENCH / CLÉ MIXTE À CLIQUET / RATSCHEN-RINGGABELSCHLÜSSEL / CHIAVE COMBINATA A CRICCO / CHAVE DE BOCA E LUNETAS COM ROQUETE / КЛЮЧ ТРЕЩЕТОЧНЫЙ КОМБИНИРОВАННЫЙ**

COD.	AF mm	g
74820	8	20
74822	10	28
74824	12	32
74825	13	46
74826	14	55
74829	17	90



■ **LLAVES FIJAS / OPEN-END WRENCHES / CLÉS À FOURCHE / GABELSCHLUSSEL / CHIAVI FISSE / CHAVES DUAS BOCAS / РОЖКОВЫЕ КЛЮЧИ**

■ **MM**

COD.	AF mm	g
71967	5-5,5	
71660	6-7	
71968	8-9	20
71661	8-10	
71825	10-11	
71662	10-12	30
71824	12-13	40
71663	12-14	50
71890	14-15	70
71664	14-17	
71826	16-17	
71665	17-19	100
71827	18-19	
71666	19-22	
71973	20-22	
71974	21-23	150
71667	22-24	
71975	24-27	
71976	25-28	250
71977	30-32	300



■ **INCH**

COD.	AF Inch	g
71891	1/4-5/16	
71892	5/16-3/8	20
71893	3/8-7/16	30
71894	1/2-9/16	
71895	9/16-5/8	50
71896	19/32-11/16	
71897	5/8-11/16	
71898	11/16-3/4	100
71899	3/4-25/32	
71900	3/4-7/8	
71901	13/16-7/8	150
71902	15/16-1	200
71903	1-1.1/8	
71904	1.1/16-1.1/8	250
71905	1.1/16-1.1/4	300



■ LLAVES COMBINADAS / COMBINATION WRENCHES / CLÉS MIXTES / GABELSCHLUSSEL / CHIAVI FISSE / CHAVES DUAS BOCAS / КОМБИНИРОВАННЫЕ КЛЮЧИ

■ MM

COD.	AF mm	g
74311	3	
74312	4	15
74313	5	
71978	6	20
71668	7	
71669	8	30
71670	9	
71671	10	
71672	11	40
71673	12	
71674	13	
71675	14	50
71676	15	
71677	17	100
71979	18	125
71678	19	150
71679	22	200
71680	24	250
71980	25	270
71981	26	300
71982	27	
71983	28	350
71984	29	400
71681	30	410
71985	32	450
71986	36	500
71987	41	750
71988	46	1050



■ INCH

COD.	AF inch	g
71828	7/32	15
71829	15/64	
71832	1/4	20
71830	5/16	30
71831	7/16	40
71833	1/2	50



■ LLAVES ACODADAS / DOUBLE OFFSET RING WRENCHES / CLÉS CONTRE-COUDÉES / RINGSCHLUSSEL / CHIAVI POLIGONALI / CHAVES LUNETAS / КЛЮЧИ ДВОЙНАЯ ИЗОГНУТАЯ ЗВЕЗДОЧКА

■ MM

COD.	AF mm	g
71989	5-5,5	20
71682	6-7	
71990	6-8	
71991	8-9	
71683	8-10	30
71992	9-11	
71993	10-11	
71684	10-12	
71994	11-13	40
71995	12-13	45
71685	12-14	50
71996	13-15	70
71997	14-15	80



COD.	AF mm	g
71998	14-16	90
71686	14-17	
71687	17-19	100
71999	18-19	
72000	18-20	125
71688	19-22	
72001	20-22	150
72002	21-23	200
71689	22-24	250
72003	24-27	300
72004	25-28	350
72005	26-29	370
72006	27-30	400
72007	30-32	450
72008	28-36	470
72009	32-36	500
72010	41-46	600

■ **LLAVES HEXAGONALES / HEXAGONAL KEYS / CLÉS MÂLES / INBUSSCHLÜSSEL / CHIAVI ESAGONALI / CHAVES HEXAGONAIS / ШЕСТИГРАННИК**

■ **STANDARD**

■ **MM**

COD.	AF mm	L (mm)	A (mm)	g
71963	1,5	45	14	5
71964	2	48	16	10
71965	2,5	55	18	
71966	3	60	20	
72043	3,5	65	23	15
71712	4	70	25	
71713	5	80	28	20
71714	6	90	32	50
71972	7	95	34	70
71715	8	100	36	90
72044	9	105	38	110
71716	10	110	40	130
72045	11	120	42	150
72046	12	125	45	180
72047	14	140	55	210
72048	17	160	65	250

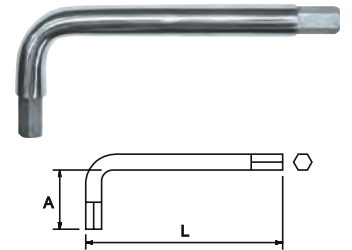

■ **SERIE LARGA / LONG SERIE / SÉRIE LONGUE / LANGE FORM / SERIE LUNGA / SERIE LONGA / ВЫСОКАЯ СЕРИЯ**

■ **MM**

COD.	AF mm	L (mm)	A (mm)	g
72049	1,5	90	14	
72050	2	100	16	10
72051	3	110	20	15
72052	3,5	115	23	25
72053	4	120	25	
72054	5	130	28	30
72055	6	145	32	55
72056	7	155	34	90
72057	8	160	36	120
72058	9	175	38	130
72059	10	180	40	160

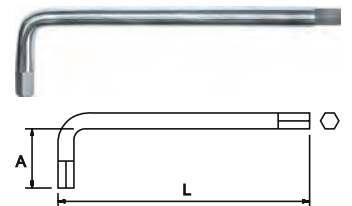

**LLAVES HEXAGONALES DE BOLA / BALLPOINT HEXAGONAL KEYS / CLÉS MÂLES À TÊTE SPHÉRIQUE / KUGELKOPF INBUSSCHLÜSSEL / CHIAVI ESAGONALI CON TESTA SFERICA / CHAVES HEXAGONAIS ESFERICAS / ШЕСТИГРАННЫЕ КЛЮЧИ С ШАРОВОЙ ГОЛОВКОЙ**

■ **MM**

COD.	AP mm	L (mm)	A (mm)	g
72060	1,5	90	14	5
72061	2	100	16	10
72062	2,5	110	18	15
72063	3	125	20	20
71717	4	140	25	30
71718	5	155	28	40
72064	5,5	175	32	50
71719	6	190	34	70
72065	7	200	36	90
71720	8	210	38	110
72066	9	230	40	130
71721	10	240	42	150
72067	11	260	45	180
72068	12	280	55	210
72069	14	300	65	250
72070	17			

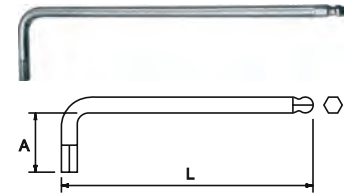

■ **INCH**

COD.	AP inch	L (mm)	A (mm)	g
71838	1/16	90	14	5
71839	5/64	100	16	10
71840	3/32	110	18	15
71841	1/8	125	20	20
71842	5/32	140	25	30
71843	3/16	155	28	40
71844	7/32	175	32	50
71845	1/4	190	34	60
71846	5/16	200	36	90
71847	3/8	210	38	120

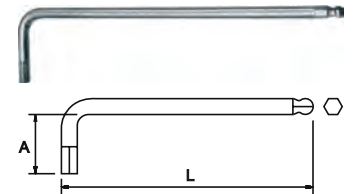

**LLAVE ALLEN CON MANGO EN "T" / ALLEN KEY WITH "T" HANDLE / CLÉ HEXAGONALE EMMANCHÉE EN T / INBUSSCHLÜSSEL MITT-GRIFF / CHIAVE A T ESAGONALE CON IMPUGNATURA IN PLASTICA / CHAVES MACHO SEXTAVADO COM CABO EM T / КЛЮЧ АЛЕН С РУЧКОЙ «Т»**

COD.	AP mm	T mm	T mm	g
72503	3	43	155	65
72504	4			
72505	5			
72506	6			
72507	8	55	165	75
72508	10			



■ **LLAVE AJUSTABLE / ADJUSTABLE WRENCH / CLÉ À MOLETTE / ROLLGABELSCHÜSSEL / CHIAVE REGOLABILI A RULLINO / CHAVE AJUSTAVEL / РАЗВОДНЫЕ КЛЮЧИ**

COD.	L (inch)	L (mm)	CAP. (mm)	g
71654	6	150	19	70
71655	8	200	25	110
71656	10	250	30	220
79448	12	300	34	400



LLAVE DINAMOMÉTRICA / TORQUE WRENCH / CLÉ DYNAMOMETRIQUE / DREHMOMENTSCHLÜSSEL / CHIAVE DINAMOMETRICA / CHAVE DINAMOMETRICA / РЕВЕРСИВНЫЕ ДИНАМОМЕТРИЧЕСКИЕ КЛЮЧИ

COD.	AF inch	L (mm)	N.m	g
79440	3/8	360	5-50	420
79441		405	10-100	475
79442	1/2	500	20-200	565
79443		595	50-250	645
79444			60-300	
79445	3/4	1040	150-750	2450
79446	1	1253	200-1000	4350



G12

COD.	AF inch	L (mm)	N.m	g
74296	1/2	410	30-160	500



G12

COD.	AF inch	L (mm)	N.m	g
72540	3/8	310	10-15	400



G12

COD.	AF inch	L (mm)	N.m	g
74912	3/8	300	8-50	400



G12

LLAVES DE VASO / SOCKET WRENCHES / DOUILLES / STECKSCHLUSSEL / DOPEN / CHAVES DE SAIXA / ГОЛОВКИ

1/4"

STANDARD

MM

COD.	AF mm	g
71701	4	
71702	5	
71703	6	5,0
71704	7	
71705	8	
71706	9	10
71707	10	
71708	11	15
71709	12	
71710	13	20
71711	14	



INCH

COD.	AF inch	g
72039	1/8	
72040	3/16	5,0
72041	1/4	
72042	3/8	10



LLAVE DE CARRACA REVERSIBLE / REVERSIBLE RATCHET HANDLE / CLÉ À CLIQUET RÉVERSIBLE / UMSCHALTKNARRE / CHIAVE A CRICCO REVERSIBILE / ROQUETE REVERSIBLE / РЕВЕРСИВНАЯ ТРЕЩЕТКА

COD.	AF inch	L (mm)	g
71783	1/4	150	180



MANGO CORREDIZO EN "T" / SLIDING "T" HANDLE / POIGNÉE COULISSANTE / T-GLEITGRIFF / ASTA CON QUADRO ESCORREVOLO / CABO "T" CORREDIÇO / ПОДВИЖНАЯ "Т" РУЧКА

COD.	AF inch	L (mm)	g
72497	1/4	150	150



G12 GARANTIA 12 MESES / 12 MONTHS OF WARRANTY / 12 MOIS DE GARANTIE / 12 MONATEN GARANTIE / 12 MAANDEN GARANTIE / 12 MESI DI GARANZIA / 12 МЕСЯЦЕВ ГАРАНТИЯ



09

ANTI-MAGNÉTICA DE TITANIO  
NON-MAGNETIC TITANIUM  
AMAGNETIQUE EN TITANE  
TITAN NICHT MAGNETISCH  
ANTIMAGNETICO AL TITANIO  
ANTI-MAGNÉTICO DE TITÂNIO  
НЕМАГНИТНЫЙ ТИТАНОВЫЙ



1/4"

ALARGADERA / EXTENSION / RALLONGE / VERLÄNGERUNG / PROLUNGA / EXTENÇÃO / УДЛИНИТЕЛЬ

COD.	AF inch	L (mm)	g
72494	1/4	100	150
72495	1/4	150	200



JUEGOS LLAVES DE VASO / SOCKET WRENCHES SETS / SETS DOUILLES / WERKZEUGSÄTZE FÜR STECKSCHLÜSSEL / KIT BUSSOLE DOPPEN / JOGOS CHAVES DE CAIXA / НАБОР ГОЛОВКИ

10 PCS.

COD.	AF inch	PCS.	g
79083	1/4	10	51079



PCS./UN.	COD. PCS.	Descripción / Description / Description	MAT.	
1	71701	Llaves de vaso / Socket wrenches	1/4", 4 mm	
	71702		1/4", 5 mm	
	71703		1/4", 6 mm	
	71704		1/4", 7 mm	
	71705		1/4", 8 mm	
	71707		1/4", 10 mm	
	71708		1/4", 11 mm	
	71710		1/4", 13 mm	
	72494		Alargadera / Extension	1/4", 100 mm
	71783		Llave de carraca / Ratchet handle	1/4"

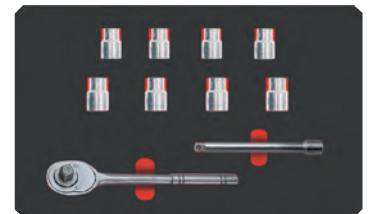

3/8"

STANDARD

MM

COD.	AF mm	g
72011	4	15
72012	5	
72013	6	20
72014	7	
72015	8	
72016	9	
71691	10	25
71692	11	
71693	12	
71694	13	
71695	14	35
71696	15	45
71697	16	
71698	17	
71699	18	60
71700	19	



INCH

COD.	AF inch	g
72017	5/16	
72018	3/8	25
72019	7/16	
72020	1/2	
72021	9/16	40
72022	5/8	45
72023	11/16	60
72024	1.1/16	80
72025	1.1/4	90



3/8"

**SERIE LARGA / LONG SOCKET / SÉRIE LONGUE / LANGE SERIE / SERIE LUNGA / SERIE LONGA / ВЫСОКАЯ СЕРИ**

COD.	AF mm	g
72026	6	
72027	7	
72028	8	
72029	9	
72030	10	
72031	11	
72032	12	
72033	13	
72034	14	60
72035	15	70
72036	16	75
72037	17	90
72038	18	



**LLAVE DE CARRACA REVERSIBLE / REVERSIBLE RATCHET HANDLE / CLÉ À CLIQUET RÉVERSIBLE / UMSCHALTKNARRE / CHIAVE A CRICCO REVERSIBILE / ROQUETE REVERSIBLE / РЕВЕРСИВНАЯ ТРЕЩЕТКА**

COD.	AF inch	L (mm)	g
71784	3/8	180	230



**MANGO CORREDIZO EN "T" / SLIDING "T" HANDLE / POIGNÉE COULISSANTE / T-GLEITGRIFF / ASTA CON QUADRO ESCORREVOLO / CABO "T" CORREDIÇO / ПОДВИЖНАЯ "Т" РУЧКА**

COD.	AF inch	L (mm)	g
72498	3/8	250	250



**ALARGADERA / EXTENSION / RALLONGE / VERLÄNGERUNG / PROLUNGA / EXTENÇÃO / УДЛИНИТЕЛЬ**

COD.	AF inch	L (mm)	g
72491	3/8	100	150
72492	3/8	200	250



**ARTICULACIÓN UNIVERSAL / UNIVERSAL JOINT / CARDAN UNIVERSEL / KARDANGELNENK / SNODO CARDANICO / CARDAN UNIVERSAL / ШАРНИР**

COD.	AF inch	g
72500	3/8	100



**BERBIQUÍ / SPEEDER HANDLE / VILEBREQUIN / KURBEL / LEVA GIROBECCHINO / MANIVELA / КОЛЕНЧАТАЯ РУЧКА**

COD.	AF inch	L (mm)	g
72496	3/8	400	300



**MANGO ARTICULADO / SWIVEL HANDLE / MANCHE ARTICULÉ / GELENKGRIFF / MANICO ARTICOLATO / CABO ARTICULADO / ГИБКАЯ РУКОЯТКА**

COD.	AF inch	g
72502	3/8	300



09

ANTI-MAGNÉTICA DE TITANIO  
NON-MAGNETIC TITANIUM  
AMAGNETIQUE EN TITANE  
TITAN NICHT MAGNETISCH  
ANTIMAGNETICO AL TITANIO  
ANTI-MAGNÉTICO DE TITÂNIO  
НЕМАГНИТНЫЙ ТИТАНОВЫЙ



3/8"

JUEGOS LLAVES DE VASO / SOCKET WRENCHES SETS / SETS DOUILLES / WERKZEUGSÄTZE FÜR STECKSCHLÜSSEL / KIT BUSSOLE DOPPEN / JOGOS CHAVES DE CAIXA / НАБОР ГОЛОВКИ

10 PCS.

COD.	AF inch	PCS.		Kg
79084	3/8	10	51079	1,1

PCS./UN.	COD. PCS.	Descripción / Description / Description	MAT.	
1	72013	Llaves de vaso / Socket wrenches	3/8", 6 mm	
	72014		3/8", 7 mm	
	72015		3/8", 8 mm	
	71691		3/8", 10 mm	
	71692		3/8", 11 mm	
	71694		3/8", 13 mm	
	71698		3/8", 17 mm	
	71700		3/8", 19 mm	
	72491		Alargadera / Extension	3/8", 100 mm
	71784		Llave de carraca / Ratchet handle	3/8"



1/2"

STANDARD

MM

COD.	AF mm	g
71850	7	
71851	8	25
71852	9	
71853	10	
71854	11	
71855	12	30
71856	13	
71857	14	
71858	15	
71859	16	35
71860	17	
71861	18	
71862	19	40
71863	20	
71864	21	45
71865	22	50
71866	23	
71867	24	55
71868	25	
71869	26	60
71870	27	65
71871	28	80
71872	29	90
71873	30	100
71874	31	105
71875	32	120



INCH

COD.	AF inch	g
71876	1/4	25
71877	7/16	
71878	1/2	30
71879	9/16	
71880	5/8	35
71881	11/16	
71882	3/4	40
71883	13/16	
71884	7/8	50
71885	15/16	55
71886	1	60
71887	1.1/16	70
71888	1.1/8	90



LLAVE DE CARRACA REVERSIBLE / REVERSIBLE RATCHET HANDLE / CLÉ À CLIQUET RÉVERSIBLE / UMSCHALTKNARRE / CHIAVE A CRICCO REVERSIBILE / ROQUETE REVERSIBILE / РЕВЕРСИВНАЯ ТРЕЩЕТКА

COD.	AF inch	L (mm)	g
71785	1/2	220	300



1/2"

**MANGO CORREDIZO EN "T" / SLIDING "T" HANDLE / POIGNÉE COULISSANTE / T-GLEITGRIFF / ASTA CON QUADRO ESCORREVOLO / CABO "T" CORREDIÇO / ПОДВИЖНАЯ "Т" РУЧКА**

COD.	AF inch	L (mm)	g
<b>72499</b>	1/2	250	250



**ALARGADERA / EXTENSION / RALLONGE / VERLÄNGERUNG / PROLUNGA / EXTENÇÃO / УДЛИНИТЕЛЬ**

COD.	AF inch	L (mm)	g
<b>72493</b>	1/2	100	150



**ARTICULACIÓN UNIVERSAL / UNIVERSAL JOINT / CARDAN UNIVERSEL / KARDANGELENK / SNODO CARDANICO / CARDAN UNIVERSAL / ШАРНИР**

COD.	AF inch	g
<b>72501</b>	1/2	150



**JUEGOS LLAVES DE VASO / SOCKET WRENCHES SETS / SETS DOUILLES / WERKZEUGSÄTZE FÜR STECKSCHLÜSSEL / KIT BUSSOLE DOPPEN / JOGOS CHAVES DE CAIXA / НАБОР ГОЛОВКИ**

13 PCS.

COD.	AF inch	PCS.	51053	Kg
<b>79085</b>	1/2	13	51053	2,1



PCS./UN.	COD. PCS.	Descripción / Description / Description	MAT.
	71851		1/2", 8 mm
	71853		1/2", 10 mm
	71584		1/2", 11 mm
	71856		1/2", 13 mm
	71860		1/2", 17 mm
	71862		1/2", 19 mm
1	71865	Llaves de vaso / Socket wrenches	1/2", 22 mm
	71867		1/2", 24 mm
	71870		1/2", 27 mm
	71873		1/2", 30 mm
	71875		1/2", 32 mm
	72493	Alargadera / Extension	1/2", 100 mm
	71785	Llave de carraca / Ratchet handle	1/2"

Titanio / Titanium





**DESTORNILLADORES / SCREWDRIVERS / TOURNEVIS / HANDSCHRAUBER / CACCIAVITI / CHAVES DE FENDA / ОТВЕРТКИ**

**ELECTRICISTA / ELECTRICIAN / ELECTRICIEN / ELEKTRIKER / PER ELETTRICISTI / ELETRICISTA / ЭЛЕКТРИЧЕСКАЯ**

COD.	mm	mm	mm	g
<b>72071</b>	50			50
<b>71971</b>	100	3		60
<b>71969</b>	150		75	65
<b>71722</b>	100	4		70
<b>72072</b>	150			70
<b>72073</b>	100	5		75
<b>71723</b>	150		90	75
<b>72074</b>	100	6		80
<b>72075</b>	125		100	80
<b>71970</b>	150	8		90
<b>71724</b>	200		115	90
<b>71725</b>	300	10		100







COD.			
72193	50		50
72194	100	3	
72195	150		60
72196	100	4	
72197	150		70
72198	100	5	
72199	150		75
72200	100	6	
72201	125		90
72202	150	8	
72203	200		100
72204	300	10	120





**CARACTERÍSTICAS / FEATURES / CARACTÉRISTIQUES**

Todo titanio / All titanium / Tout titane

**PHILIPS**

COD.				
71726	PH-0	75	75	50
71727	PH-1	100	90	55
71728	PH-2	150	110	70
71729	PH-3	200		80
71730	PH-4	250	115	100





COD.			
72205	PH-0	75	40
72206	PH-1	100	50
72207	PH-2	150	70
72208	PH-3	200	80
72209	PH-4	250	100



**CARACTERÍSTICAS / FEATURES / CARACTÉRISTIQUES**

Todo titanio / All titanium / Tout titane

**DESTORNILLADOR ACODADO / OFFSET SCREWDRIVER / TOURNEVIS CONTRE COUDÉ / WINKELSCHRAUBENDREHER / CACCIAVITE A SQUADRA / CHAVE DE PARAFUSOS ANGULAR / КОЛЕНЧАТАЯ ОТВЕРТКА**

COD.	L (mm)		
72528	100	4 x 0,8	10
72529	150	6 x 1	25
72530	250	10 x 1,5	90



**MISCELÁNEA / MISCELLANEOUS / DIVERS / VERSCHIEDENE / MISCELLANEA / MISTURA / ПАЗНОЕ**

**RAYADOR / MARKING TOOL / POINTE À TRACER / MARKIERWERKEUG / ATREZZO PER MARCARE / RISCADOR / МАРКИРОВОЧНЫЙ ИНСТРУМЕНТ**

COD.	L (mm)	
72531	200	12



**BARRA PATA DE GALLO / CROW BAR / PINCE À LEVIER / BRECHSTANGE / BARRA A ZAMPA DI GALLO / PÉ DE CABRA / МОТИРОВОККА**

COD.	L (inch)	
72537	18	370



■ BARRA DE DESENCOFRAR / WRECKING BAR / PINCE MONSEIGNEUR / BRECHEISEN / APRICASSE CON LEVA CHIODI / PE DE CABRA / КРЮК

COD.	L (inch)	
72538	18	750



■ PINZAS / TWEEZERS / BRUCELLES / GREIFPINZETTEN / PINZETTE DI PRECISIONES / PINÇAS / ПИНЦЕТЫ

COD.	L (mm)	
71657	155	30



COD.	L (mm)	
71658	155	30



COD.	L (mm)	
71659	155	30



■ BOTADOR / PIN PUNCH / CHASSE-GOUPILLES / SPLINTREIBER / PUNTE / PUNÇÃO / ЦИЛИНДРИЧЕСКИЙ ПРОБОЙНИК

COD.	L (mm)	Ø (mm)	
72077	110	2,5	25
72078		3	35
72079		4	45
72080	120	5	55
72081	130	6	55



■ MARTILLO DE BOLA / BALL PEIN HAMMER / MARTEAU À BOULE / SCHLOSSER HAMMER / MARTELO A PALLA / MARTELO DE BOLA / МОЛОТОК С ШАРОВОЙ ГОЛОВКОЙ

COD.	
72083	450





■ TIJERA / SCISSORS / CISEAUX / SCHEREN / FORBICI / TESOURA / НОЖНИЦЫ

COD.	L (mm)	
71889	225	180



■ CUCHILLOS / KNIVES / COUTEAUX / MESSER / COLTELLI / FACAS / НОЖИ

COD.	L (mm)		
72509	225	100	75
72527	250	130	80



■ CINCEL / FLAT CHISEL / COUTEAU ET BEDANE / MAURERMEISSEL / SCALPELLI PER MURATORI / ESCOPRO / ПЛОСКОЕ ЗУБИЛО

COD.	L x W (mm)	
72534	165 x 16	130
72535	125 x 22	



■ ESPÁTULA / SCRAPER / SPATULE / SPACHTEL / SPATOLA / ESPATULA / СКРЕБОК

COD.			
72536	90	40	35



■ SET

COD.		PCS.	
74392		7	



  

PCS./UN.	COD. PCS.	Descripción / Description / Description	
1	71648	Alicate telefonista / Long nose plier	180 mm
	71650	Alicate corte diagonal / Diagonal cutting plier	160 mm
	71655	Llave ajustable / Adjustable wrench	8"
	72073	Destornilladores electricista / Electrician screwdrivers	5 x 100
	71723		5 x 150
	71726		PH-0
	71728	Destornilladores Philips / Philips screwdriver	PH-2



■ JUEGO UNIVERSAL / UNIVERSAL SET / SET UNIVERSELLE / UNIVERSAL SET / KIT UNIVERSALE / JOGOS UNIVERSAIS / УНИВЕРСАЛЬНЫЕ НАБОРЫ

■ 25 PCS.

COD.	PCS.		MAT.	
79082	25	51056	Titanio / Titanium / Titane	4

PCS./UN.	COD. PCS.	Descripción / Description / Description	MAT.
1	71660	Llaves fijas / Open-end wrenches	6-7 mm
	71968		8-9 mm
	71825		10-11 mm
	71824		12-13 mm
	71890		14-15 mm
	71826		16-17 mm
	71827		18-19 mm
	71973		20-22 mm
	71975		24-27 mm
	71977		30-32 mm
	71647		Alicate universal / Combination pliers
	71656	Llave ajustable / Adjustable wrench	10"
	71712	Llaves hexagonales / Hexagonal keys	4 mm
	71713		5 mm
	71714		6 mm
	71972		7 mm
	71715		8 mm
	72044		9 mm
	71716		10 mm
	71971		3 x 100 mm
	71722		4 x 100 mm
	72073		5 x 100 mm
	72075	6 x 125 mm	
	71727	Destornilladores electricista / Electrician screwdrivers	PH1
	71728	Destornilladores Philips / Philips screwdriver	PH2





Mercedes-Benz

## **MERCEDES-BENZ (Malaysia)**

*Chantramohan Suparmaniam*  
Production Manager

"EGA Master is a trusted supplier that offers us the best service in the industry. We see EGA Master as a key partner for us going forward."



**INOX**

**HERRAMIENTA INOX**  
*INOX (STAINLESS STEEL) TOOLS*  
**OUTILLAGE INOX**  
*INOX WERKZEUGE*  
**UTENSILI INOX**  
*FERRAMENTA INOX*  
**ИНСТРУМЕНТ ИЗ НЕРЖАВЕЮЩЕЙ СТАЛИ**

**10**



**INOX**



# INOX

Un mundo desarrollándose exponencialmente rápido, genera crecientes necesidades en materia de seguridad y aplicaciones de tecnología avanzada.

**EGA Master** ha desarrollado una nueva gama de herramientas de acero inoxidable para proporcionar soluciones a algunas de estas necesidades. El acero inoxidable 420\* contribuye a evitar contaminaciones, oxidación y cumplimiento de requisitos de sala blanca.

*A world developing exponentially fast, creates increasing needs on safety and technologically advanced applications.*

*EGA Master has developed a new range of stainless steel tools to provide solutions to some of these needs. 420\* stainless steel contributes to avoid contaminations, rusting and complying with clean room environment requirements.*

Le monde en plein développement exponentiel, crée une augmentation des besoins en matière de sécurité et applications de technologie avancées

**EGA Master** a développé une nouvelle gamme d'outillages en acier inoxydable pour apporter des solutions à certains de ces besoins. L'acier inoxydable 420\* contribue à éviter la contamination, l'oxydation en respectant les règles ambiantales des milieux extra sain.



\* Los armarios portaherramientas inox están fabricados en acero inoxidable 430.  
*The stainless steel roller cabinets are made of 430 stainless steel.*  
 Les servantes en inox sont fabriquées en acier inoxydable 430.



Propiedades requeridas Property required Propriétés recommandées	Necesarias en Where needed Nécessité dans	Sectores Sectors Secteurs	Porque no acero al carbón Why not carbon steel Pourquoi pas d'acier au carbone	Porque acero inoxidable Why stainless steel Pourquoi acier inoxydable
<p>Tolerancia cero o baja a contaminación y partículas Zero or low tolerance to contamination and particles Tolérance base ou zéro à la contamination et aux particules</p>	<p>Producción esterilizada en entornos críticos Sterile production in critical environments Production stérilisé dans des milieux critiques</p>	Laboratorios / <i>Laboratories</i> / Laboratoires	<p>Sólo pueden ser esterilizadas unas pocas decenas de veces, ya que el cromado utilizado para evitar que se oxiden se deteriorará, se descascarillará con el tiempo, contaminando el proceso. They can only be sterilized few dozens of times, as the chrome plating used to avoid rust will deteriorate and chip off with time, contaminating the process Ne peuvent être stérilisé qu'une dizaine de fois vu que le chromé utilisé évitant l'oxidation se détériore et se déséquilibre avec le temps, contaminant le process</p>	<p>Los materiales y el acabado utilizados en su producción permiten su esterilización miles de veces. Materials and finishing used in their production enables sterilizing them thousands of times Les matériaux et la finition utilisés dans sa fabrication lui permette plus de 1000 stérilisation .</p>
		Bioteología y biomedicina <i>Biotech and biomedical</i> Biotechnologie et biomedical		
		Salas blancas / <i>Cleanrooms</i> / Chambres stériles		
		Farmacéuticas / <i>Pharmaceutical</i> / Pharmaceutique		
		Producción de nutrientes <i>Nutrient production</i> Production alimentaire		
		Industria nuclear <i>Nuclear industry</i> Industries nucléaires		
		Producción de obleas de silicio <i>Silicone wafer production</i> Production de plaquettes de silicium		
		Proceso de alimentos <i>Food processing</i> Process alimentaire		
<p>Evitar la oxidación prematura de piezas por la contaminación de partículas Avoiding premature rust of parts by particle contamination Évite l'échange d'oxidation de pièces par la contamination de particules</p>	<p>El uso de herramientas en componentes de acero inoxidable, tales como tornillos, tuercas, arandelas, tubos, barras, etc. Using tools on Stainless Steel components such as screws, nuts, washers, pipes, bars, etc. L'utilisation d'outils en acier inoxydables tout comme les vis, les écrous, rondelles, tubes, barres, ect.</p>	Sector naval / <i>Ship building</i> / Secteur naval	<p>Las herramientas de acero al carbono pueden dejar pequeñas partículas sobre los componentes de acero inoxidable, los cuales se pueden contaminar, y oxidarse Carbon steel tools can leave small particles on stainless steel components, which will get contaminated, and make them rust Les outils en acier de carbone peuvent laisser des petites particules sur les composants en acier inoxydables, qui peuvent être contaminés et oxidar</p>	<p>Las herramientas de acero inoxidable no contaminan otros componentes de acero INOX y, por lo tanto, no se produce su oxidación Stainless steel tools will not contaminate other SS components and thus not make them get rusted Les outils en aciers inoxydable ne contamineront les autres composant et par conséquent ne produiront aucune oxidation</p>
		Construcción / <i>Construction</i> / Construction		
		Fabricación / <i>Manufacturing</i> / Fabrication		
		Automóvil / <i>Automotive</i> / Automobile		
		Aeronáutica / <i>Aeronautics</i> / Aeronautique		
		Aplicaciones marítimas <i>Marine applications</i> Application maritimes		
		Estaciones de servicio y energía <i>Power</i> Station service et énergétique		
		Industria química <i>Chemical Industries</i> Industries chimiques		
<p>Aumento de la vida útil de la herramienta Increasing tool lifetime Augmentation de la durée de vie utile des outils</p>	<p>Entornos corrosivos Corrosive environments Milieux corrosifs</p>	Naval (buques / mantenimiento de barcos) <i>Naval ( vessels / ship maintenance)</i> Naval ( navires / manutention de bateaux)	<p>Las herramientas de acero al carbono, incluso cuando están cromados, se oxidarán rápidamente en áreas altamente corrosivas, dejándolas inutilizables y teniendo que reemplazarlas con frecuencia Carbon steel tools, even when they are chrome plated, will rust quickly in highly corrosive areas, leaving them unusable and having to replace them frequently Les outils en carbone, inclus quand ils sont en polie s'oxiderront de façon rapide dans des milieux hautement corosifs et les laissant inutilisables et par conséquent seront remplacés plus fréquemment</p>	<p>El acero inoxidable es un acero de bajo contenido en carbono enriquecido con un 10 % de cromo, que permite la formación de una capa de óxido de cromo invisible que protege el núcleo de la oxidación. Incluso cuando la capa está dañada químicamente o mecánicamente, el oxígeno del medio ambiente reparará la capa de nuevo Stainless steel is a low carbon steel enriched with above 10% chromium, which allows the formation of an invisible chromium oxide layer that protects the core from rusting. Even when the layer is damaged chemically or mechanically, the oxygen of the environment will repair the layer again L'acier inoxidale est un acier a faible composition en carbone enrichi avec 10% de Chrome qui permet la formation d'une pellicule d'oxide de Chrome invisible qui protège de l'oxidation. Meme quand la pellicule est détérioré par un impact l'oxigène du milieux ambiant repare la pellicule</p>
		Subacuático / <i>Subaquatic</i> / Subaquatique		
		Offshore (Petróleo & Gas / Energía eólica...) <i>Offshore (Oil &amp; Gas / Wind Power...)</i> Offshore (pétrole & gaz / énergie éolienne)		
		Plantas de energía nuclear <i>Nuclear Power plants</i> Plate-forme d'énergie nucléaire		
		Industria química <i>Chemical industries</i> Industries chimique		
		Entornos húmedos <i>Humid environments</i> Environnements humide		
		Proceso húmedo <i>Wet processing</i> Processus humide		
		Desalinización del agua <i>Water desalination</i> Évacuation des eaux		
		Explotación salinera <i>Salt production</i> Exploitation des salines		
		Plantas de tratamiento de aguas <i>Water treatment plants</i> Plate-forme du traitement des eaux		

Como ocurre con los aceros al carbono, hay docenas de diferentes aceros inoxidables y cada uno de ellos presenta diferentes propiedades para diferentes aplicaciones: algunos son más resistentes a la corrosión, otros son más resistentes a la tracción, otros más duros... Pero ninguno de ellos mejor en todo el conjunto de propiedades.

EGA Master ha elegido el acero inoxidable 420 para la fabricación de sus herramientas, ya que combina de manera óptima las diferentes propiedades requeridas para la fabricación y uso de herramientas de acero inoxidable:

*As with carbon steels, there are dozens of different stainless steels, each of them presenting different properties for different applications. Some are more resistant to rust, some other are stronger, some harder... But non of them is best in all properties.*

*EGA Master has chosen 420 Stainless steel for the manufacturing its tools, as it combines optimally different properties required for manufacturing and use of stainless steel tools:*

Comme avec les aciers au carbone, il existe une douzaine de différents aciers inoxydables, qui chacun d'entre eux présente différentes propriétés pour différentes applications. Certains sont plus résistant à la corrosion, d'autres plus résistant à la traction, d'autres plus dur... Mais aucun meilleur dans un ensemble de propriétés.

EGA Master a élu l'acier inoxydable 420 pour la fabrication de ses outils, vu qu'il associe de façon optimale les différentes propriétés requise pour la fabrication et l'utilisation d'outils en acier inoxydable:

Dureza / Hardness / Dureté	38-48 HRC
Resistencia a la tracción / Tensile Strength / Resistance à la traction	1200-1500 N/mm <sup>2</sup> (MPa)

Propiedades / Properties / Propriétés	Aplicación y beneficios / Application & benefits / Application et bénéfices
Evita la contaminación / Avoiding contamination / Evite la contamination	No contaminación por hierro o cromo-níquel / No iron or chrome-nickel contamination / Pas de contamination de l'acier et Chrome-nikel
Esterilización / Sterilization / Stérilisation	Miles de procesos de esterilización / Thousands of sterilizing processes / 1000 process de stérilisation
Vida útil / Durability / Longévité	La dureza, resistencia y protección antioxido proporcionan mayor durabilidad / Combination of hardness, resistance and antirust protection makes it most durable / La dureté, resistance et protection antioxidante proportionne une plus grande longévité
Coste / Cost / Coût	Siendo una aleación para su producción en serie, junto con sus buenas propiedades de fabricación hace que sea más rentable para la fabricación de herramientas / Being a mass production alloy together with having good manufacturing properties makes it most cost effective for tool manufacturing / En aléation à une fabrication en serie, et en conjunction avec ses excellentes propriétés de fabrication fait qu'il est plus rentable

MAT: 420		
Composición / Composition / Composition	C	0,16 - 0,25 %
	Mn	≤ 1,00 %
	Si	≤ 1,00 %
	Cr	12 % - 14 %

En EGA Master estamos seguros de que la prevención es la cura más eficaz no sólo para aumentar la seguridad, sino también desde el punto de vista de la reducción de costes. Eliminar el riesgo de transferencia ferrosa es un factor clave para aumentar la rentabilidad a largo plazo, mientras se mantienen la seguridad en procesos y personas.

*In EGA Master we are sure that prevention is the most effective cure not only for increased safety, but also from an cost effective point of view. Eliminating the risk of ferrous transfer is a key factor for increasing profitability on the long term, while keeping processes, and people, safe.*

Chez EGA Master nous sommes sûr que la prévention est le remède le plus efficace pour augmenter la sécurité, mais aussi d'un point de vue de reduction de coût. Eliminer le risque de transfert ferreux est un facteur clef pour augmenter la rentabilité a long terme, tout en maintenant la sécurité du process et des personnes.

**PRECAUCIONES**  
**CAUTION**  
**PRÉCAUTIONS**

Estas herramientas no están clasificadas como antimagnéticas, sino que se trata de herramientas fabricadas en acero inoxidable martensítico-ferromagnético cuya permeabilidad magnética es muy superior a la unidad.

*These tools are not classified as non-magnetic but tools made of martensitic - ferromagnetic stainless steel whose magnetic permeability is much higher than the unit.*

Cet outillage n'est pas classé comme antimagnétique, il s'agit d'un outillage fait en acier inoxydable martensitique-ferromagnétique dont la perméabilité magnétique est très supérieure à l'unité.

■ **ALICATES / PLIERS / PINCES / ZANGEN / PINZE / ALICATES / ПЛОСКОГУБЦЫ**

■ **UNIVERSALES / COMBINATION / UNIVERSELLES / KOMBIZANGEN / UNIVERSALI / UNIVERSAIS / КОМБИНИРОВАННЫЕ**

COD.	L (mm)	g
<b>38137</b>	160	230
<b>38138</b>	200	360



■ **BOCA PLANA / FLAT NOSE / BECS PLATS / FLACHZANGEN / BECCHI PIATTI / PONTAS CHATAS / УТКОНОСЫ**

COD.	L (mm)	g
<b>38139</b>	160	90



■ **BOCA REDONDA / ROUND NOSE / BECS RONDS / RUNDZANGEN / BECCHI TONDI / PONTAS REDONDAS / КРУГЛОГУБЦЫ**

COD.	L (mm)	g
<b>38140</b>	160	70



■ **TELEFONISTA / LONG NOSE / TÉLÉPHONE / TELEFONZANGEN / TELEFONISTI / TELEFONISTA / СУДЛИННЕННЫМИ НОСАМИ**

COD.	L (mm)	g
<b>38141</b>	160	90
<b>38142</b>	200	150



■ **TELEFONISTA BOCA CURVA / BENT NOSE PLIERS / TÉLÉPHONE BECS COUDÉS / TELEFONZANGEN GEBOGEN / TELEFONISTI BECCHI PIEGATI / TELEFONISTA PONTAS CURVAS / C ИЗОГНУТЫМИ НОСАМИ**

COD.	L (mm)	g
<b>38143</b>	160	80
<b>38144</b>	200	150



■ **CORTE DIAGONAL / DIAGONAL CUTTING PLIERS / COUPANTES DIAGONALES / SEITENSCHNEIDER / TAGLIO LATERALE / CORTE DIAGONAL / УДЛИНЕННЫЕ ТОНКИЕ**

COD.	L (mm)	g
<b>38145</b>	160	120



■ **CORTE DIAGONAL REFORZADO / HEAVY DUTY CUTTING NIPPERS / COUPANTES RENFORCEÉS / VERSTÄRKTER SEITENSCHNEIDER / TAGLIO LATERALE RINFORZATO / CORTE DIAGONAL REFORÇADO / УСИЛЕННЫЕ БОКОРЕЗЫ**

COD.	L (mm)	g
<b>38146</b>	180	190



■ **CORTE FRONTAL / END CUTTING NIPPER / COUPANTES DEVANT / VORSCHNEIDER / TAGLIO FRONTALE / CORTE FRONTAL / КЛЕЩИ**

COD.	L (mm)	g
<b>38147</b>	160	170



■ **CORTE FRONTAL ELECTRICISTA / END CUTTING NIPPER (ELECTRICIAN) / COUPANTES DEVANT ELECTRICIEN / ELEKTRIKER VORSCHNEIDER / TAGLIO FRONTALE PER ELETTRICISTI / CORTE FRONTAL ELECTRICISTA / КЛЕЩИ (ЭЛЕКТРИЧЕСКИЕ)**

COD.	L (mm)	g
<b>38148</b>	200	260



■ PELACABLES / WIRESTRIPPER / PINCES À DÉNUDER / ABISOLIERZANGEN / PINZE SPELAFILI / DECAPADORES / КЛЕЩИ ДЛЯ ЗАЧИСТКИ КОНТАКТОВ

COD.	L (mm)	
38149	160	120



■ BIMAT

■ UNIVERSALES / COMBINATION / UNIVERSELLES / KOMBIZANGEN / UNIVERSALI / UNIVERSAIS / КОМБИНИРОВАННЫЕ

COD.	L (mm)	
38000	160	230
38001	180	280
38002	200	360



**BIMAT** | Modelo registrado / Registered model / Modèle enregistré

■ BOCA PLANA / FLAT NOSE / BEC PLATS / FLACHZANGEN / BECCHI PIATTI / PONTAS CHATAS / УТКОНОСЫ

COD.	L (mm)	
38003	160	170



**BIMAT** | Modelo registrado / Registered model / Modèle enregistré

■ BOCA REDONDA / ROUND NOSE / BECS ROUNDS / RUNDZANGEN / BECCHI TONDI / PONTAS REDONDAS / КРУГЛОГУБЦЫ

COD.	L (mm)	
38004	160	150



**BIMAT** | Modelo registrado / Registered model / Modèle enregistré

■ TELEFONISTA / LONG NOSE / TÉLÉPHONE / TELEFONZANGEN / TELEFONISTI / TELEFONISTA / С УДЛИННЕННЫМИ НОСАМИ

COD.	L (mm)	
38005	160	170
38006	200	230



**BIMAT** | Modelo registrado / Registered model / Modèle enregistré

■ TELEFONISTA BOCA CURVA / BENT NOSE PLIERS / TÉLÉPHONE BECS COUDÉS / TELEFONZANGEN GEBOGEN / TELEFONISTI BECCHI PIEGATI / TELEFONISTA PONTAS CURVAS / С ИЗОГНУТЫМИ НОСАМИ

COD.	L (mm)	
38007	160	160
38008	200	230



**BIMAT** | Modelo registrado / Registered model / Modèle enregistré

■ BOCA AGUJA / LONG NEEDLE NOSE / LONG BECS DEMI-RONDS / FLACHZANGE MIT LANGEM MAUL / BECCHI TONDI AFFUSOLATI / PONTAS AGULHA / УДЛИННЕННЫЕ ТОНКИЕ

COD.	L (mm)	
38086	160	110



**BIMAT** | Modelo registrado / Registered model / Modèle enregistré

■ CORTE DIAGONAL / DIAGONAL CUTTING PLIERS / COUPANTES DIAGONALES / SEITENSCHNEIDER / TAGLIO LATERALE / CORTE DIAGONAL / УДЛИННЕННЫЕ ТОНКИЕ

COD.	L (mm)	
38009	160	200
38010	190	230



**BIMAT** | Modelo registrado / Registered model / Modèle enregistré

**CORTE DIAGONAL REFORZADO / HEAVY DUTY CUTTING NIPPERS / COUPANTES RENFORCEÉS / VERSTÄRKTER SEITENSCHNEIDER / TAGLIO LATERALE RINFORZATO / CORTE DIAGONAL REFORÇADO / УСИЛЕННЫЕ БОКОРЕЗЫ**

COD.	L (mm)	
<b>38011</b>	180	270
<b>38012</b>	200	340

**BI-MAT** | Modelo registrado / Registered model / Modèle enregistré



**CORTE FRONTAL / END CUTTING NIPPER / COUPANTES DEVANT / VORSCHNEIDER / TAGLIO FRONTALE / CORTE FRONTAL / КЛЕЩИ**

COD.	L (mm)	
<b>38013</b>	160	250

**BI-MAT** | Modelo registrado / Registered model / Modèle enregistré



**CORTE FRONTAL ELECTRICISTA / END CUTTING NIPPER (ELECTRICIAN) / COUPANTES DEVANT ELECTRICIEN / ELEKTRIKER VORSCHNEIDER / TAGLIO FRONTALE PER ELETTRICISTI / CORTE FRONTAL ELETRICISTA / КЛЕЩИ (ЭЛЕКТРИЧЕСКИЕ)**

COD.	L (mm)	
<b>38014</b>	160	250
<b>38015</b>	200	340

**BI-MAT** | Modelo registrado / Registered model / Modèle enregistré



**PELACABLES / WIRESTRIPPER / PINCES À DÉNUDER / ABISOLIERZANGEN / PINZE SPELAFILI / DECAPADORES / КЛЕЩИ ДЛЯ ЗАЧИСТКИ КОНТАКТОВ**

COD.	L (mm)	
<b>38016</b>	160	200

**BI-MAT** | Modelo registrado / Registered model / Modèle enregistré



**ALICATES MINIS / MINI PLIERS / PINCES MINI / MINI ZANGEN / PINZE MINI / ALICATES MINI / ПЛОСКОГУБЦЫ МИНИ**

**UNIVERSALES / COMBINATION / UNIVERSELLES / KOMBIZANGEN / UNIVERSALI / UNIVERSAIS / КОМБИНИРОВАННЫЕ**

COD.	L (mm)	
<b>38081</b>	125	90



**BOCA PLANA / FLAT NOSE / BEC PLATS / FLACHZANGEN / BECCHI PIATTI / PONTAS CHATAS / УТКОНОСЫ**

COD.	L (mm)	
<b>38082</b>	130	70



■ **BOCA REDONDA / ROUND NOSE / BECS RONDS / RUNDZANGEN / BECCHI TONDI / PONTAS REDONDAS / КРУГЛОГУБЦЫ**

COD.	L (mm)	
<b>38083</b>	130	80



■ **TELEFONISTA / LONG NOSE / TÉLÉPHONE / TELEFONZANGEN / TELEFONISTI / TELEFONISTA / СУДЛИННЕННЫМИ НОСАМИ**

COD.	L (mm)	
<b>38084</b>	130	70



■ **TELEFONISTA BOCA CURVA / BENT NOSE PLIERS / TÉLÉPHONE BECS COUDÉS / TELEFONZANGEN GEBOGEN / TELEFONISTI BECCHI PIEGATI / TELEFONISTA PONTAS CURVAS / С ИЗОГНУТЫМИ НОСАМИ**

COD.	L (mm)	
<b>38085</b>	130	80



■ **CORTE DIAGONAL / DIAGONAL CUTTING PLIERS / COUPANTES DIAGONALES / SEITENSCHNEIDER / TAGLIO LATERALE / CORTE DIAGONAL / УДЛИНЕННЫЕ ТОНКИЕ**

COD.	L (mm)	
<b>38087</b>	115	70



■ **CORTE DIAGONAL TRIANGULAR / DIAGONAL CUTTING TRIANGULAR / COUPANTES DIAGONALE TRIANGULAIRE / SEITENSCHNEIDER / TAGLIO LATERALE TRIANGOLARE / CORTE DIAGONAL TRIANGULAR / БОКОРЕЗЫ ТРЕУГОЛЬНЫЕ**

COD.	L (mm)	
<b>38088</b>	115	80



■ **CORTE FRONTAL / END CUTTING NIPPER / COUPANTES DEVANT / VORSCHNEIDER / TAGLIO FRONTALE / CORTE FRONTAL / КЛЕЩИ**

COD.	L (mm)	
<b>38089</b>	110	65





■ **TENAZAS / PINCERS / PINCES / ZANGE / TENAGLIE / ALICATES / КЛЕЩИ**

■ **DE CANAL / BOX JOINT / MULTIPRISE ENTREPASSÉE / WASSERPUMPENZANGE / PINZE REGOLABILI / BICO DE PAPAGAIO / ШАРНИРНЫЕ**

COD.	L (inch)	
38066	10	320
38067	12	515





■ **PICO DE LORO / GROOVE JOINT / MULTIPRISE À CRÉMAILLÈRE / WASSERPUMPENZANGE / PINZE REGOLABILI / BICO DE PAPAGAIO / КЛЕЩИ ЖЕЛОБКОВОГО ТИПА**

COD.	L (inch)	
38176	10	360
38177	12	610

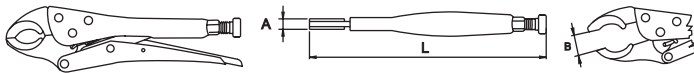

■ **GRIP / GRIP / PINCE ÉTAU / GRIPZANGE / PINZE GRIP / PRESSÃO / СТРУБИЦА**





COD.	L (inch)	L (mm)	A (mm)	B (mm)		
38178	10	225	12	40	480	8



■ **LLAVES / WRENCHES / CLÉS / SCHLÜSSEL / CHIAVI / CHAVES / КЛЮЧИ**



■ **LLAVE AJUSTABLE / ADJUSTABLE WRENCH / CLÉ À MOLETTE / ROLLGABELSCHÜSSEL / CHIAVE REGOLABILI A RULLINO / CHAVE AJUSTAVEL / РАЗВОДНЫЕ КЛЮЧИ**

COD.	L (inch)	L (mm)		
38171	8	200	24	240
38172	10	250	28	445
38173	12	300	34	680

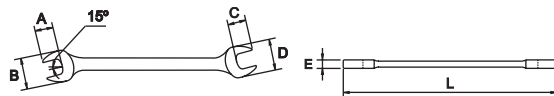

■ **LLAVES FIJAS / OPEN-END WRENCHES / CLÉS À FOURCHE / GABELSCHLÜSSEL / CHIAVI FISSE / CHAVES DUAS BOCAS / РОЖКОВЫЕ КЛЮЧИ**





COD.		L (mm)	A (mm)	B (mm)	C (mm)	D (mm)	E (mm)	
38622	6-7	145	6	16	7	14	4,5	19
38623	8-9	165	8	18	9	24	5	38
38624	10-11	190	10	27	11	24	6	56
38625	12-13	210	14	31	12	27	7	60
38626	14-15	230	17	37	14	31	7,5	95
38627	16-17	260	19	41	19	41	8,5	140
38628	22-24	260	22	47	24	51	9	250



■ **LLAVES COMBINADAS / COMBINATION WRENCHES / CLÉS MIXTES / GABEL RINGSCHLÜSSEL / CHIAVI COMBINATE / CHAVES BOCA E LUNETA / КОМБИНИРОВАННЫЕ КЛЮЧИ**

■ **MM**

COD.	L (mm)		
38090		6	10
38091	115	7	20
38092		8	
38093		9	
38094	140	10	30
38095		11	40
38096	160	12	50
38097		13	60
38098	180	14	70
38099	200	15	80



COD.	L (mm)	AF mm	g
38100		16	90
38101	200	17	110
38102		18	120
38103	225	19	140
38104		20	170
38105	250	21	180
38106		22	200
38107	270	23	220
38108		24	260
38109		25	300
38110	290	26	310
38111		27	340
38112		28	380
38113	320	29	390
38114		30	430
38115	350	32	550

#### INCH

COD.	L (mm)	AF inch	g
38116	115	1/4	17
38117		5/16	
38118	140	11/32	
38119		3/8	
38121		13/32	38
38120	160	7/16	
38122		1/2	48
38123	180	9/16	70
38124		5/8	
38125	200	11/16	120
38126	225	3/4	150
38127		13/16	
38128	250	25/32	210
38129		7/8	
38130	270	15/16	
38131		31/32	260
38132	290	1	
38133		1.1/16	320
38134		1.1/8	
38135	320	1.3/16	400
38136	350	1.1/4	525
38168	360	1.3/8	710
38169	380	1.1/2	990



#### KIT DEMO 6 LLAVES / 6 SPANNER DEMO KIT / KIT DÉMO. 6 CLÉS / DEMOKIT 6 SCHLÜSSEL / KIT 6 CHIAVI DI DIMOSTRAZIONE / KIT DEMO 6 CHAVES / ДЕМО НАБОР 6 КЛЮЧЕЙ

COD.	g
69342	300

COD.	mm
61727	Aerospacial / Aerospacial
38092	INOX
73062	1000V
70172	Cu-Be
70684	Al-Bron
71669	Titanio / Titanium

8



■ **LLAVES HEXAGONALES / HEXAGONAL KEYS / CLÉS MÂLES / INBUSSCHLÜSSEL / CHIAVI ESAGONALI / CHAVES HEXAGONAIS / ШЕСТИГРАННЫЕ КЛЮЧИ**

■ **STANDARD**

■ **MM**

COD.	AF mm	L (mm)	A (mm)	g
38170	1,5	47	16	
38186	2	52		5,0
38036	2,5	55	18	
38037	3			
38038	3,5	65	20	10
38039	4	70	25	
38040	5	85	26	20
38041	6	90	32	30
38042	7	95	34	40
38043	8	100	36	60
38044	9	105	38	80
38045	10	110	40	110
38046	11	120	42	150
38047	12	125	45	170

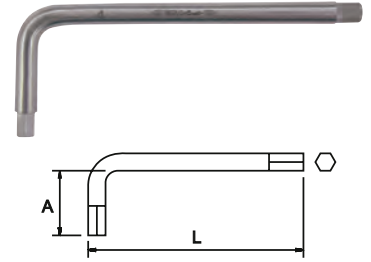

■ **INCH**

COD.	AF inch	L (mm)	A (mm)	g
38603	5/64	50	16	3,3
38604	3/32	60	18	4,0
38589	1/8	65	20	10
38590	9/64			
38591	5/32	75	25	15
38592	3/16	85	28	
38593	7/32	95	32	
38594	1/4	100	34	40
38595	5/16	110	36	
38596	3/8	115	38	50

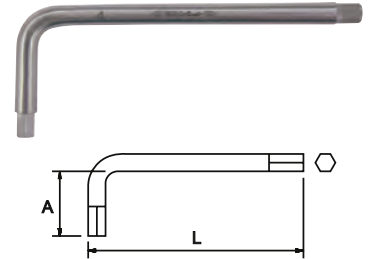

■ **STANDARD CON PUNTA DE BOLA / STANDARD BALLPOINT / STANDARD EMBOUT SPHÉRIQUE / KUGELKOPF- WINKELSCHRAUBER / STANDARD CON PUNTA A SFERA / STANDARD COM BOLA / СТАНДАРТНЫЙ С ШАРИКОВОЙ ГОЛОВКОЙ**

COD.	AF mm	L (mm)	A (mm)	g
38597	1,5	45	14	
38598	2,5	55	18	3,3
38599	3	60	20	8
38600	4	70	25	14
38601	6	90	32	35
38602	10	112	40	135

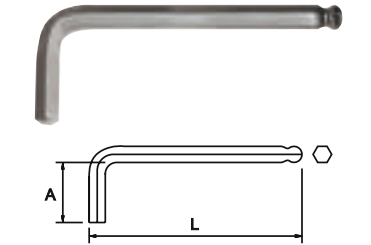

■ **SERIE LARGA / LONG PATTERN / SÉRIE LONGUE / LANGE SERIE / SERIE LUNGA / SERIE LONGA / ДЛИННЫЙ**

■ **MM**

COD.	AF mm	L (mm)	A (mm)	g
38048	2,5	105	18	
38049	3	110	20	10
38050	4	120	25	20
38051	5	130	28	30
38052	6	145	32	50
38053	7	155	34	70
38054	8	160	36	100
38055	9	175	38	150
38056	10	180	40	180
38057	11	190	42	250
38058	12	200	45	290

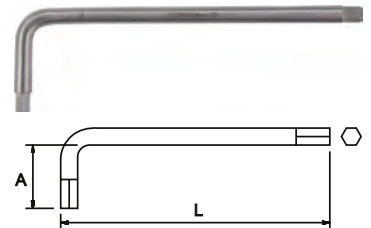

**BOLA SERIE LARGA / LONG PATTERN BALLPOINT / SÉRIE LONGUE À TÊTE SPHÉRIQUE / KUGELKOPF- INBUSSCHLÜSSEL / SERIE LUNGA CON TESTA SFERICA / ESFERICAS, SERIE LONGA / ДЛИННЫЙ С ШАРОВОЙ ГОЛОВКОЙ**

COD.	AF mm	L (mm)	A (mm)	g
38640	1,5	65	16	6
38641	2	75	18	6
38642	2,5	90	21	7
38643	3	95	23	14
38644	4	105	29	24
38645	5	120	33	38
38646	5,5	130	38	50
38647	6	141	44	60
38648	8	158	50	140
38649	10	180	50	220

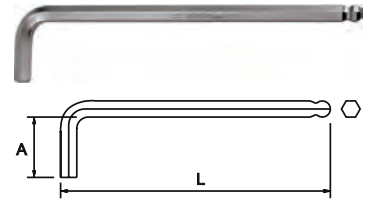

**CON MANGO EN T / T-HANDLE / AVEC POIGNÉE EN T / T-GRIFF / CON IMPUGNATURA A T / COM CABO EM T / Т-РУЧКА**

COD.	mm	L (mm)	L1 (mm)	L2 (mm)	L3 (mm)	g
38630	2,5					35
38631	3	175	115			40
38632	4					50
38633	5,5					75
38634	6			60	110	100
38635	7					120
38636	8	185	125			135
38637	9					155
38638	10					180

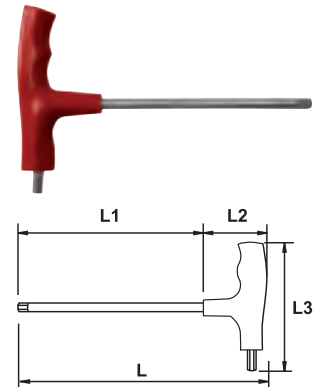

**LLAVES DE VASO / SOCKET WRENCHES / DOUILLES / STECKSCHLÜSSEL / BUSSOLE DOPPEN / CHAVES DE CAIXA / ГОЛОВКИ**

- 1/4"
- STANDARD
- MM
- 6 PT.

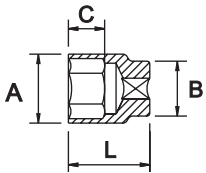

COD.	AF mm	L (mm)	A (mm)	B (mm)	C (mm)	Pt	g
38235	4		7				
38236	5		8				20
38237	6		10	12			
38238	7	23	12		15		
38239	8						30
38240	9		15	15		6	
38241	10						
38242	11		17	17			40
38243	12	25	19	19	17		
38244	13						50
38245	14		20	20			



# 10

**HERRAMIENTA INOX**  
**INOX (STAINLESS STEEL) TOOLS**  
**OUTILLAGE INOX**  
**INOX WERKZEUGE**  
**UTENSILI INOX**  
**FERRAMENTA INOX**  
**ИНСТРУМЕНТ ИЗ НЕРЖАВЕЮЩЕЙ СТАЛИ**



1/4"

■ 12 PT.

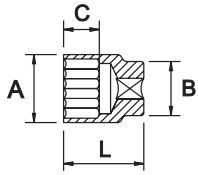

N!

COD.	AF mm	L (mm)	A (mm)	B (mm)	C (mm)	Pt	g
38403	4	23	7	12	15	12	20
38404	5		8				
38405	6		10				
38406	7		12				
38407	8		15				
38408	9	25	15	17	17	30	
38409	10		17				
38410	11		19				
38411	12		20				
38412	13	25	19	19	17	40	
38413	14		20				



■ INCH

■ 6 PT.

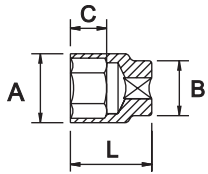

N!

COD.	AF inch	L (mm)	A (mm)	B (mm)	C (mm)	Pt	g
38246	3/16	23	9	12	15	6	20
38247	7/32		10				
38248	1/4		12				
38249	5/16		15				
38250	3/8		17				
38251	7/16	25	17	17	17	30	
38252	1/2		19				
38253	9/16		21				



■ 12 PT.

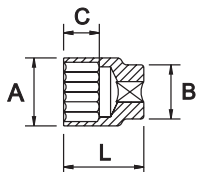

N!

COD.	AF inch	L (mm)	A (mm)	B (mm)	C (mm)	Pt	g
38414	3/16	23	9	12	15	12	20
38415	7/32		10				
38416	1/4		12				
38417	5/16		15				
38418	3/8		17				
38419	7/16	25	17	17	17	30	
38420	1/2		19				
38421	9/16		21				



1/4"

■ **SERIE LARGA / LONG PATTERN / SÉRIE LONGUE / LANGE SERIE / SERIE LUNGA / SERIE LONGA / ДЛИННЫЙ**

■ **MM**

■ **6 PT.**

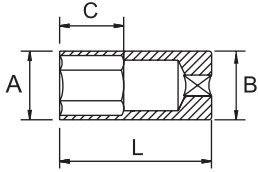

COD.	AF mm	L (mm)	A (mm)	B (mm)	C (mm)	Pt	g
38254	4	50	12	12	13	6	30
38255	5						
38256	6						
38257	7						
38258	8		15	15			40
38259	9						
38260	10		17	17			50
38261	11						
38262	12		19	19			60
38204	13						
38263	14		21	21			80



■ **12 PT.**

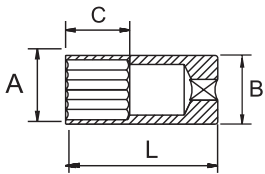

COD.	AF mm	L (mm)	A (mm)	B (mm)	C (mm)	Pt	g
38422	4	50	12	12	13	12	30
38423	5						
38424	6						
38425	7						
38426	8		15	15			40
38427	9						
38428	10		17	17			50
38429	11						
38430	12		19	19			60
38431	13						
38432	14		21	21			80



# 10

**HERRAMIENTA INOX**  
**INOX (STAINLESS STEEL) TOOLS**  
**OUTILLAGE INOX**  
**INOX WERKZEUGE**  
**UTENSILI INOX**  
**FERRAMENTA INOX**  
**ИНСТРУМЕНТ ИЗ НЕРЖАВЕЮЩЕЙ СТАЛИ**



1/4"

■ INCH

■ 6 PT.

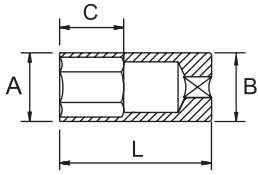

COD.	AF inch	L (mm)	A (mm)	B (mm)	C (mm)	Pt	g
38264	3/16	50	12	12	13	6	30
38265	7/32						
38266	1/4						
38267	5/16						
38268	3/8		15	15			
38269	7/16		17	17			
38270	1/2		19	19			
38271	9/16		21	21			



■ 12 PT.

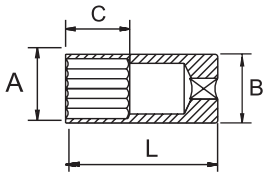

COD.	AF inch	L (mm)	A (mm)	B (mm)	C (mm)	Pt	g
38433	3/16	50	12	12	13	12	30
38434	7/32						
38435	1/4						
38436	5/16						
38437	3/8		15	15			
38438	7/16		17	17			
38439	1/2		19	19			
38440	9/16		21	21			



**LLAVE DE CARRACA REVERSIBLE / REVERSIBLE RATCHET HANDLE / CLÉ À CLIQUET RÉVERSIBLE / UMSCHALTKNARRE / CHIAVE A CRICCO REVERSIBILE / ROQUETE REVERSIVEL / РЕВЕРСИВНАЯ ТРЕЩЕТКА**



COD.	AF inch	L (mm)	A (mm)	B (mm)	C (mm)	g	Box
38203	1/4	200	32	15	27	260	1



# 10

**HERRAMIENTA INOX**  
**INOX (STAINLESS STEEL) TOOLS**  
**OUTILLAGE INOX**  
**INOX WERKZEUGE**  
**UTENSILI INOX**  
**FERRAMENTA INOX**  
**ИНСТРУМЕНТ ИЗ НЕРЖАВЕЮЩЕЙ СТАЛИ**



- 3/8"
- STANDARD
- MM
- 6 PT.

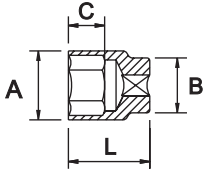

COD.	AF mm	L (mm)	A (mm)	B (mm)	C (mm)	Pt	g
38274	6	31	11	21		6	40
38275	7		12				
38276	8		13				
38277	9		14				
38278	10		15				
38279	11	16	20			70	
38280	12	17					
38281	13	18					
38282	14	34	21	22		90	
38283	15		22				
38284	16		24				
38285	17		24				
38286	19	26	25	22		110	
38287	20	27					
38288	22	30					



■ 12 PT.

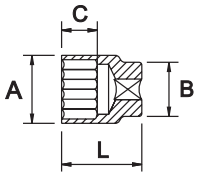

COD.	AF mm	L (mm)	A (mm)	B (mm)	C (mm)	Pt	g
38443	6	31	11	21		12	40
38444	7		12				
38445	8		13				
38446	9		14				
38447	10		15				
38448	11	16	20			70	
38449	12	17					
38450	13	18					
38451	14	34	21	22		90	
38452	15		22				
38453	16		24				
38454	17		24				
38455	19	26	25	22		110	
38456	20	27					
38457	22	30					





3/8"

■ INCH

■ 6 PT.

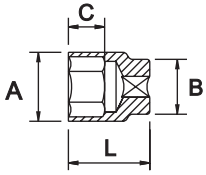

COD.	AF inch	L (mm)	A (mm)	B (mm)	C (mm)	Pt	g
38289	1/4		11				30
38290	5/16		13				40
38291	3/8	31	15	21			50
38292	7/16		16				
38293	1/2		18				
38294	9/16	34	21	22	20	6	70
38295	5/8		22				
38296	11/16		24				
38297	3/4	38	26	25			110
38298	13/16		28				



■ 12 PT.

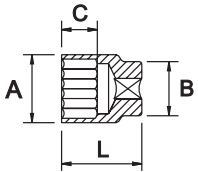

COD.	AF inch	L (mm)	A (mm)	B (mm)	C (mm)	Pt	g
38458	1/4		11				30
38459	5/16		13				40
38460	3/8	31	15	21			50
38461	7/16		16				
38462	1/2		18				
38463	9/16	34	21	22	20	12	70
38464	5/8		22				
38465	11/16		24				
38466	3/4	38	26	25			110
38467	13/16		28				



3/8"

■ **SERIE LARGA / LONG PATTERN / SÉRIE LONGUE / LANGE SERIE / SERIE LUNGA / SERIE LONGA / ДЛИННЫЙ**

■ **MM**

■ **6 PT.**

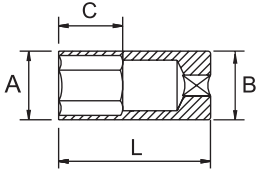

COD.	AF mm	L (mm)	A (mm)	B (mm)	C (mm)	Pt	g			
38301	6	60	11	21		6	110			
38302	7		12							
38303	8		13							
38304	9		14							
38305	10		15							
38306	11		16							
38307	12	65	17	21						
38308	13		18							
38309	14		21							
38310	15		70				22	22		120
38311	16						24			
38312	17	24								
38313	19	26								
38314	20	70	27	25	26	160				
38315	22		30				200			



■ **12 PT.**

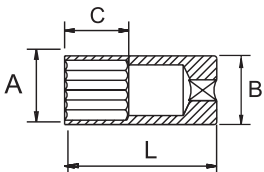

COD.	AF mm	L (mm)	A (mm)	B (mm)	C (mm)	Pt	g			
38470	6	60	11	21		12	110			
38471	7		12							
38472	8		13							
38473	9		14							
38474	10		15							
38475	11		16							
38476	12	65	17	21	21	120				
38477	13		18							
38478	14		21							
38479	15		70				22	22		140
38480	16						24			
38481	17	24								
38482	19	26								
38483	20	70	27	25	26	160				
38484	22		30				200			



# 10

**HERRAMIENTA INOX**  
**INOX (STAINLESS STEEL) TOOLS**  
**OUTILLAGE INOX**  
**INOX WERKZEUGE**  
**UTENSILI INOX**  
**FERRAMENTA INOX**  
**ИНСТРУМЕНТ ИЗ НЕРЖАВЕЮЩЕЙ СТАЛИ**



3/8"

- INCH
- 6 PT.

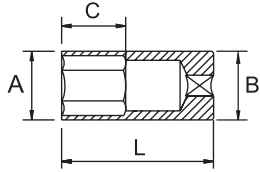

COD.	AF inch	L (mm)	A (mm)	B (mm)	C (mm)	Pt	g
38316	1/4	60	11	21	21	6	110
38317	5/16		13				
38318	3/8		15				
38319	7/16	65	16	22	21	6	120
38320	1/2		18				
38321	9/16		21				
38322	5/8	70	22	24	25	6	140
38323	11/16		24				
38324	3/4		26				
38325	13/16		28		26		200



12 PT.

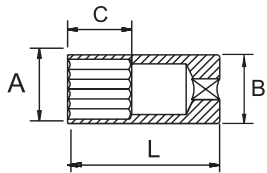

COD.	AF inch	L (mm)	A (mm)	B (mm)	C (mm)	Pt	g
38485	1/4	60	11	21	21	12	110
38486	5/16		13				
38487	3/8		15				
38488	7/16	65	16	22	21	12	120
38489	1/2		18				
38490	9/16		21				
38491	5/8	70	22	24	25	6	140
38492	11/16		24				
38493	3/4		26				
38494	13/16		28		26		200



1/2"

- STANDARD
- MM
- 6 PT.

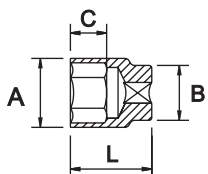

COD.	AF mm	L (mm)	A (mm)	B (mm)	C (mm)	Pt	g
38326	6	38	12	24	23	6	40
38327	7		13				
38328	8		14				
38329	9						50



Si no encuentra el artículo que necesita, consúltenos en [info@egamaster.com](mailto:info@egamaster.com) o en [www.egamaster.com](http://www.egamaster.com)  
 If you can't find the item you look for, please ask us in [info@egamaster.com](mailto:info@egamaster.com) or in [www.egamaster.com](http://www.egamaster.com)  
 Si vous ne trouvez pas l'article que vous désirez, consultez-nous à [info@egamaster.com](mailto:info@egamaster.com) ou à [www.egamaster.com](http://www.egamaster.com)

1/2"

COD.	AF mm	L (mm)	A (mm)	B (mm)	C (mm)	Pt	g
38330	10		15				
38331	11		16				60
38332	12		18				
38187	13		19	24			
38333	14		20				
38334	15		21				70
38335	16		24				
38188	17		25	25			80
38336	18	38	26				90
38189	19		27				
38337	20		28				100
38338	21		29	26	23	6	
38190	22		30				110
38339	23		32				150
38198	24		33				
38340	25		36	28			160
38341	26		37	29			
38199	27		38	30			170
38342	28		40				
38343	29	40	40	31			190
38221	30		43	32			200
38222	32		50	37			230
38223	36	43					300

12 PT.

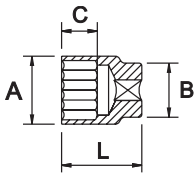

COD.	AF mm	L (mm)	A (mm)	B (mm)	C (mm)	Pt	g
38495	6		12				60
38496	7		13				
38497	8		14				55
38498	9		15				
38499	10		16				58
38500	11		18	24			
38501	12		19				
38502	13		20				60
38503	14		21				
38504	15		24				70
38506	17	38	25	25			80
38507	18		26				
38508	19		27		23	12	100
38509	20		28				75
38510	21		29	26			80
38511	22		30				110
38512	23		32				150
38513	24		33				
38514	25		36	28			160
38515	26		37	29			
38516	27		38	30			170
38517	28		40				
38518	29	40	40	31			190
38519	30		43	32			200
38520	32		50	37			230
38521	36	43					300



# 10

**HERRAMIENTA INOX**  
**INOX (STAINLESS STEEL) TOOLS**  
**OUTILLAGE INOX**  
**INOX WERKZEUGE**  
**UTENSILI INOX**  
**FERRAMENTA INOX**  
**ИНСТРУМЕНТ ИЗ НЕРЖАВЕЮЩЕЙ СТАЛИ**



1/2"

■ INCH

■ 6 PT.

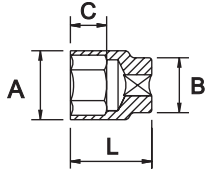

COD.	AF <sup>g</sup> inch	L (mm)	A (mm)	B (mm)	C (mm)	Pt	g
38344	1/4	38	12	24	23	6	40
38345	5/16		13				50
38346	3/8		15				60
38347	7/16		16				70
38348	1/2		19				80
38349	9/16		20	90			
38350	19/32		22	110			
38351	5/8		24	150			
38352	11/16		25	160			
38353	3/4		27	170			
38354	25/32	28	26	25	23	6	190
38355	13/16	29	28	25	23	6	230
38356	7/8	30	30	26	25	6	230
38357	15/16	33	35	28	25	6	230
38358	1	35	36	29	25	6	230
38359	1.1/16	36	40	31	25	6	230
38360	1.1/8	40	40	31	25	6	230
38361	1.3/16	40	43	32	25	6	230
38362	1.1/4	43	50	37	25	6	230
38363	1.7/16	43	50	37	25	6	230



■ 12 PT.

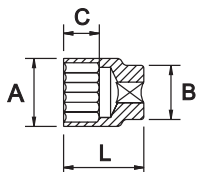

COD.	AF <sup>g</sup> inch	L (mm)	A (mm)	B (mm)	C (mm)	Pt	g
38522	1/4	38	12	24	23	12	40
38523	5/16		13				50
38524	3/8		15				60
38525	7/16		16				70
38526	1/2		19				80
38527	9/16		20	90			
38528	19/32		22	110			
38529	5/8		24	150			
38530	11/16		25	160			
38531	3/4		27	26			25
38532	25/32	28	30	25	23	12	230
38533	13/16	29	33	26	23	12	230
38534	7/8	30	35	28	23	12	230
38535	15/16	33	36	29	23	12	230
38536	1	35	40	31	23	12	230
38537	1.1/16	36	40	31	23	12	230
38538	1.1/8	40	43	32	23	12	230
38539	1.3/16	40	50	37	23	12	230
38540	1.1/4	43	50	37	23	12	230
38541	1.7/16	43	50	37	23	12	230



# 10

**HERRAMIENTA INOX**  
**INOX (STAINLESS STEEL) TOOLS**  
**OUTILLAGE INOX**  
**INOX WERKZEUGE**  
**UTENSILI INOX**  
**FERRAMENTA INOX**  
**ИНСТРУМЕНТ ИЗ НЕРЖАВЕЮЩЕЙ СТАЛИ**



1/2"

■ **SERIE LARGA / LONG PATTERN / SÉRIE LONGUE / LANGE SERIE / SERIE LUNGA / SERIE LONGA / ДЛИННЫЙ**

■ **MM**

■ **6 PT.**

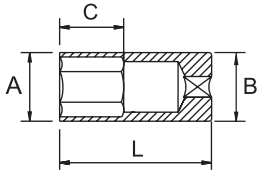

COD.	AF mm	L (mm)	A (mm)	B (mm)	C (mm)	Pt	g		
38364	6	85	12	24	29	6	160		
38365	7		13						
38366	8		14						
38367	9		15						
38368	10		16						
38369	11		18						
38370	12		19						
38371	13		20						
38372	14		21						
38373	15		24						
38374	16		25	25	180				
38224	17		26	190					
38375	18		27	26	32	6	220		
38205	19		28						
38376	20		29						
38377	21		30						
38225	22		32						
38378	23		33					27	270
38226	24		35					28	330
38379	25		36					29	340
38380	26	38	30					360	
38227	27	40	31					370	
38381	28	43	32	390					
38382	29	50	37	390					
38228	30								
38229	32								
38230	36								



■ **12 PT.**

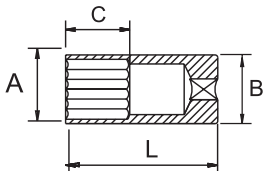

COD.	AF mm	L (mm)	A (mm)	B (mm)	C (mm)	Pt	g		
38542	6	85	12	24	29	12	160		
38543	7		13						
38544	8		14						
38545	9		15						
38546	10		16						
38547	11		18						
38548	12		19						
38549	13		20						
38550	14		21						
38551	15		24					170	
38552	16		25					25	180
38553	17								



# 10

**HERRAMIENTA INOX**  
**INOX (STAINLESS STEEL) TOOLS**  
**OUTILLAGE INOX**  
**INOX WERKZEUGE**  
**UTENSILI INOX**  
**FERRAMENTA INOX**  
**ИНСТРУМЕНТ ИЗ НЕРЖАВЕЮЩЕЙ СТАЛИ**



1/2"

COD.	AF mm	L (mm)	A (mm)	B (mm)	C (mm)	Pt	g	
38554	18	85	26	26	29	12	190	
38555	19		27				28	32
38556	20		28		30			
38557	21		29				31	32
38558	22		30	32	32			
38559	23		32				33	32
38560	24		33	34	32			
38561	25		35				35	32
38562	26		36	36	32			
38563	27		38				37	32
38564	28		38	38	32			
38565	29		40				39	32
38566	30		43	40	32			
38567	32		43				43	32
38568	36		50	50	37			

■ INCH

■ 6 PT.

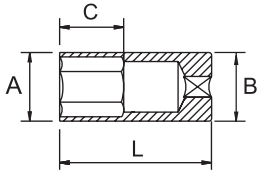

COD.	AF inch	L (mm)	A (mm)	B (mm)	C (mm)	Pt	g	
38383	1/4	85	12	24	29	6	160	
38384	5/16		13				28	32
38385	3/8		15		30			
38386	7/16		18				31	32
38387	1/2		19	32	32			
38388	9/16		21				33	32
38389	19/32		24	34	32			
38390	5/8		26				35	32
38391	11/16		27	36	32			
38392	3/4		28				37	32
38393	25/32		29	38	32			
38394	13/16		30				39	32
38395	7/8		33	40	32			
38396	15/16		35				43	32
38397	1		40	43	32			
38398	1.1/16		43				50	32
38399	1.1/8	40	50	37				
38400	1.3/16							
38401	1.1/4							
38402	1.7/16							



1/2"

■ 12 PT.

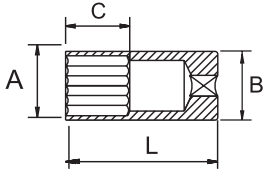

COD.	AF inch	L (mm)	A (mm)	B (mm)	C (mm)	Pt	g
38569	1/4		12				160
38570	5/16		13				170
38571	3/8		15				180
38572	7/16		18				190
38573	1/2		19				200
38574	9/16		21				210
38575	19/32		24				220
38576	5/8		24				230
38577	11/16		26				240
38578	3/4		27				250
38579	25/32	85	28			12	260
38580	13/16		29				270
38581	7/8		30				280
38582	15/16		33				290
38583	1		35	28			300
38584	1.1/16		36	29			310
38585	1.1/8		40	31			320
38586	1.3/16		43	32			330
38587	1.1/4		50	37			340
38588	1.7/16		50	37			390



**LLAVE DE CARRACA REVERSIBLE / REVERSIBLE RATCHET HANDLE / CLÉ À CLIQUET RÉVERSIBLE / UMSCHALTKNARRE / CHIAVE A CRICCO REVERSIBILE / ROQUETE REVERSIVEL / РЕВЕРСИВНАЯ ТРЕЩЕТКА**



COD.	AF inch	A (mm)	B (mm)	C (mm)	L (mm)	g
38200	1/2	40	20	41	250	550



**ALARGADERA / EXTENSION / RALLONGE / VERLANGERUNG / PROLUNGA / EXTENCAO / УДЛИНИТЕЛЬ**

COD.	AF inch	L (inch)	g
38220		4	350
38824	1/2	8	380
38825		10	460



**ARTICULACIÓN UNIVERSAL / UNIVERSAL JOINT / CARDAN UNIVERSEL / KARDANGELLENK / SNODO CARDANICO / CARDAN UNIVERSAL / ШАРНИР**

COD.	AF inch	g
38829	1/2	170



**MANGO CORREDIZO EN "T" / SLIDING "T" HANDLE / POIGNEE COULISSANTE / QUERGRIF / ASTA CON QUADRO SCORREVOLO / CABO "T" CORREDICO / ПОДВИЖНАЯ "Т" РУЧКА**

COD.	AF inch	L (mm)	g
38830	1/2	250	330





# 10

**HERRAMIENTA INOX**  
**INOX (STAINLESS STEEL) TOOLS**  
**OUTILLAGE INOX**  
**INOX WERKZEUGE**  
**UTENSILI INOX**  
**FERRAMENTA INOX**  
**ИНСТРУМЕНТ ИЗ НЕРЖАВЕЮЩЕЙ СТАЛИ**



1/2"

**BERBIQUÍ / SPEEDER HANDLE / VILLEBREQUIN / KURBEL / LEVA GIROBESCHINO / MANIVELA / КОЛЕНЧАТАЯ РУЧКА**

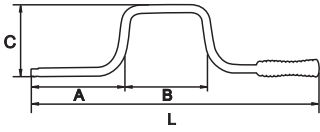

COD.	AF inch	L (mm)	A (mm)	B (mm)	C (mm)	g	Icon
<b>38831</b>	1/2	380	135	140	100	500	5



- 3/4"
- STANDARD
- MM
- 6 PT.

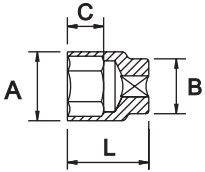

COD.	AF mm	L (mm)	A (mm)	B (mm)	C (mm)	Pt	g
<b>38671</b>	17	50	28	30	14	6	240
<b>38672</b>	19		30	33			
<b>38673</b>	21		32				
<b>38674</b>	22		33	36			
<b>38675</b>	23		34	36			
<b>38676</b>	24		36	36			
<b>38677</b>	26	36	38				
<b>38678</b>	27	38	39	24	260		
<b>38679</b>	28	39	40	24	280		
<b>38680</b>	29	40	42	38	320		
<b>38681</b>	30	42	38	26	330		
<b>38682</b>	32	55	44	26	330		
<b>38683</b>	36	55	44	42	29	450	
<b>38684</b>	38	50	43	31	500		
<b>38685</b>	41	65	55	45	34	580	
<b>38686</b>	46	70	60	37	700		
<b>38687</b>	50	70	70	48	38	900	
<b>38688</b>	55	75	75	41	1050		
<b>38689</b>	60	80	80	45	1150		



12 PT.

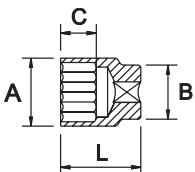

COD.	AF mm	L (mm)	A (mm)	B (mm)	C (mm)	Pt	g
<b>38709</b>	17	50	28	30	14	12	240
<b>38710</b>	19		30	33			
<b>38711</b>	21		32				
<b>38712</b>	22		33	36			
<b>38713</b>	23		34	36			
<b>38714</b>	24		36	36			
<b>38715</b>	26	36	36	17	250		



3/4"

COD.	AF mm	L (mm)	A (mm)	B (mm)	C (mm)	Pt	g
38716	27		38				250
38717	28	50	39		24		260
38718	29		40				280
38719	30		42	38			320
38720	32		44		26		330
38721	36	55	50	42	29	12	450
38722	38		43	43	31		500
38723	41	65	55	45	34		600
38724	46	70	60		37		700
38725	50		70		38		900
38726	55	75	75	48	40		1050
38727	60	80	80		45		1150

■ INCH

■ 6 PT.

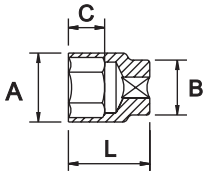

COD.	AF inch	L (mm)	A (mm)	B (mm)	C (mm)	Pt	g
38690	3/4		30				
38691	13/16		33				240
38692	7/8			36	17		
38693	15/16	50	35				250
38694	1						
38695	1.1/16		38		24		
38696	1.1/8		40		27		300
38697	1.3/16		42	38			
38698	1.1/4	55	44		28		320
38699	1.7/16			42	30	6	430
38700	1.1/2	60	50				490
38701	1.9/16		53				550
38702	1.5/8		55	45	32		600
38703	1.3/4	65	60		35		
38704	1.13/16			47			750
38705	1.7/8	70	65		39		
38706	2		70		41		900
38707	2.3/16	80	75	48	45		950
38708	2.3/8	90	85		47		1000



■ 12 PT.

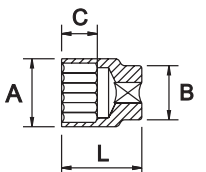

COD.	AF inch	L (mm)	A (mm)	B (mm)	C (mm)	Pt	g
38728	3/4		30				
38729	13/16		33				240
38730	7/8			36	17	12	
38731	15/16	50	35				250
38732	1						
38733	1.1/16		38		24		



3/4"

COD.	AF inch	L (mm)	A (mm)	B (mm)	C (mm)	Pt	g
38734	1.1/8	50	40		27		300
38735	1.3/16		42	38			
38736	1.1/4	55	44		28		320
38737	1.7/16			42			430
38738	1.1/2	60	50		30		490
38739	1.9/16		53				550
38740	1.5/8		55	45	32	12	600
38741	1.3/4	65	60		35		
38742	1.13/16			47			750
38743	1.7/8	70	65		39		
38744	2		70		41		900
38745	2.3/16	80	75	48	45		950
38746	2.3/8	90	85		47		1000

■ SERIE LARGA / LONG PATTERN / SÉRIE LONGUE / LANGE SERIE / SERIE LUNGA / SERIE LONGA / ВЫСОКАЯ СЕРИЯ

■ MM

■ 6 PT.

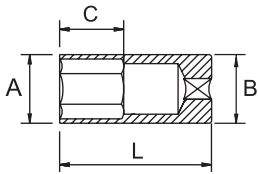

COD.	AF mm	L (mm)	A (mm)	B (mm)	C (mm)	Pt	g
38747	17		28				150
38748	19		30				320
38749	21		33	36	29		340
38750	22						380
38751	23		34				400
38752	24	49	36				420
38753	26		38	38			
38754	27		39				440
38755	28		40	36	24		
38756	29		42			6	480
38757	30			38			530
38758	32	54	45		29		580
38759	36	56	50	42	31		690
38760	38		52		30		720
38761	41	60	56	45	34		810
38762	46	66	62		40		900
38763	50	68	68	48	42		1000
38764	55	74	75	53	38		1100
38765	60	78	83	57	40		1200



3/4"

■ 12 PT.

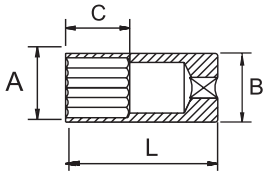

COD.	AF mm	L (mm)	A (mm)	B (mm)	C (mm)	Pt	g
38785	17		28				150
38786	19		30				320
38787	21		33	36	29		340
38788	22		34				380
38789	23		36				400
38790	24	49	38	38			420
38791	26		39	36	24		440
38792	27		40				480
38793	28		42	38		12	530
38794	29		45	42	31		580
38795	30		50	45	30		690
38796	32	54	52	45	34		720
38797	36	56	56	48	40		810
38798	38	60	62	53	38		900
38799	41	66	68	57	40		1000
38800	46	74	75	53	38		1100
38801	50	78	83	57	40		1200
38802	55						
38803	60						



■ INCH

■ 6 PT.

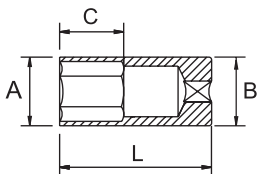

COD.	AF inch	L (mm)	A (mm)	B (mm)	C (mm)	Pt	g
38766	3/4		30				320
38767	13/16		33	36	29		350
38768	7/8		36				360
38769	15/16		37	37			420
38770	1	49	39	36	24		430
38771	1.1/16		42	38			450
38772	1.1/8		45	42	29		480
38773	1.3/16		50	42	31		520
38774	1.1/4	54	52	45	30		580
38775	1.7/16	56	55	45	34	6	660
38776	1.1/2		61	48	40		720
38777	1.9/16	60	62	48	40		760
38778	1.5/8	66	66	53	38		810
38779	1.3/4	68	68	57	40		860
38780	1.13/16		75	53	38		920
38781	1.7/8		83	57	40		980
38782	2						1080
38783	2.3/16	74					1400
38784	2.3/8	780					1650



# 10

**HERRAMIENTA INOX**  
**INOX (STAINLESS STEEL) TOOLS**  
**OUTILLAGE INOX**  
**INOX WERKZEUGE**  
**UTENSILI INOX**  
**FERRAMENTA INOX**  
**ИНСТРУМЕНТ ИЗ НЕРЖАВЕЮЩЕЙ СТАЛИ**



3/4"

12 PT.

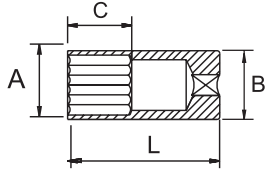

COD.	AF inch	L (mm)	A (mm)	B (mm)	C (mm)	Pt	g
38804	3/4		30				320
38805	13/16		33	36	29		350
38806	7/8						360
38807	15/16		36				420
38808	1	49	37	37			430
38809	1.1/16		39	36	24		450
38810	1.1/8		42				480
38811	1.3/16			38			520
38812	1.1/4	54	45		29		580
38813	1.7/16	56	50	42	31	12	660
38814	1.1/2		52		30		720
38815	1.9/16	60	55	45	34		760
38816	1.5/8		56				810
38817	1.3/4	66	61		40		860
38818	1.13/16		62	48			920
38819	1.7/8	68	66		42		980
38820	2		68				1080
38821	2.3/16	74	75	53	38		1400
38822	2.3/8	78	83	57	40		1650



**ALARGADERA / EXTENSION / RALLONGE / VERLANGERUNG / PROLUNGA / EXTENCAO / УДЛИНИТЕЛЬ**

COD.	AF inch	L (inch)	g
38826		4	200
38827	3/4	8	230
38828		10	260



**DESTORNILLADORES / SCREWDRIVERS / TOURNEVIS / SCHRAUBENDREHER / CACCIAVITI / CHAVES DE FENDA / ОТВЕРТКИ**

**ELECTRICISTA / ELECTRICIAN / ELECTRICIEN / ELEKTRIKER / PER ELETTRICISTI / ELETRICISTA / ЭЛЕКТРИЧЕСКАЯ**

COD.	mm	mm	mm	g
38150	80	3	75	40
38151		4		60
38152	100	5	90	90
38153		6	110	130
38154	150	8		170
38155		10	120	200
38156	200	12		260
38157	250	14		320



COD.	mm	mm	mm	g
38017	80	3	75	40
38018		4		60
38019	100	5	90	90
38020		6	110	130
38021	150	8		170
38022	200	10		200
38023	300	12	120	220
38024	200	12		260
38025	250	14		320



## PHILIPS

COD.				
38158	PH0	60	75	30
38159	PH1	80	90	80
38160	PH2	100	110	120
38161	PH3	150	120	190
38162	PH4	200	120	270



COD.				
38026	PH0	60	75	30
38027	PH1	80	90	80
38028	PH2	100	110	120
38029	PH3	150	120	190
38030	PH4	200	75	270



## POZIDRIV®\*

COD.				
38163	PZ0	60	75	40
38164	PZ1	80	90	80
38165	PZ2	100	110	120
38166	PZ3	150	120	190
38167	PZ4	200	120	270



COD.				
38031	PZ0	60	75	40
38032	PZ1	80	90	80
38033	PZ2	100	110	120
38034	PZ3	150	120	190
38035	PZ4	200	120	270



## CUÑA / WEDGE / COIN / KEIL / CUNEO / CUNHA / КЛИН

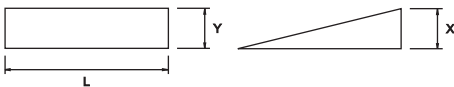

COD.	L (mm)	Y	X	
38059	80	13	6	20
38060	100		10	200
38061	150	50	13	380
38062	180		19	670
38063	200		12	470
38064	250	40	30	1170
38065	300	50	40	2340



## BOTADORES CILÍNDRICOS / PIN PUNCHES / CHASSES GOUPILLES / DURCHSCHLÄGER / PUNZONE CILINDRICO / PUNÇÕES CILÍNDRICOS / ПРОБОЙНИКИ

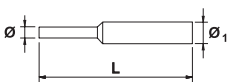

COD.	Ø (mm)	Ø 1 (mm)	L (mm)	
38610	2	8		29
38611	3	9	110	38
38612	4	10		48
38613	5	11	115	60
38614	6	12		75
38615	7	13	120	95



\*Para tornillos POZIDRIV® (Marca registrada por European Ind. Serv. Ltd.) / \*For screws POZIDRIV® (European Ind. Serv. Ltd. registered trademark) / \*Pour vis POZIDRIV® (Marque enregistrée par European Ind. Serv. Ltd.)

■ **MARTILLOS / HAMMERS / MARTEAUX / HÄMMER / MARTELLI / MARTELOS / МОЛОТКИ**

■ **MARTILLO DE BOLA / BALL PEIN HAMMER / MARTEAU À BOULE / SCHLOSSER HAMMER / MARTELLO A PALLA / MARTELO DE BOLA / МОЛОТОК С ШАРОВОЙ ГОЛОВКОЙ**

COD.	L (mm)	g
38068	350	450



■ **MACETA OCTOGONAL / SLEDGE HAMMER / MASSETTE OCTOGONALE / SCHLAGHAMMER / MAZZETTA OTTOGONALE / MARRETA OCTOGONAL / КУВАЛДА**

COD.	L (mm)	Kg
38069		1
38070	350	1,5
38071		2
38072	800	2,5
38073		3
38074	850	3,5



■ **MACETA CUADRADA TIPO ALEMÁN / GERMAN TYPE STONING HAMMER / MASSETTE TYPE ALLEMAND / FÄUSTEL / MAZZETA / MARRETA / КУВАЛДА НЕМЕЦКИЙ ТИП ДЛЯ КАМНЯ**

COD.	L (mm)	Kg
38179		1
38180		1,5
38181	400	2
38182		2,5
38183		3
38184	900	3,5



■ **MARTILLO DE EBANISTA / JOINER'S HAMMER / MARTEAU DE MENUISIER / HOLZSCHNITZERHAMMER / MARTELLO FALEGNAME / MARTELO DE PENA / СТОЛЯРНЫЙ МОЛОТОК**

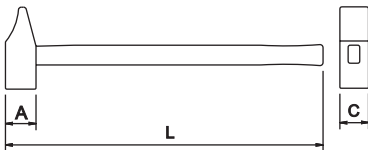

COD.	L (mm)	A (mm)	g
38075		18	250
38076	280	20	300
38077		22	350
38078	300	25	500
38079		28	590
38080	350	30	780



■ **MACETA DE NYLON / NYLON HAMMER / MARTEAU NYLON / NYLON-HAMMER / MARTELLO DI NYLON / MARTELO DE NYLON / НЕЙЛОНОВЫЙ МОЛОТОК**

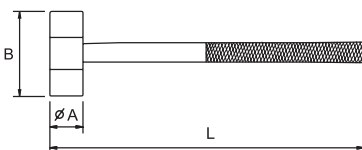

COD.	L (mm)	Ø A (mm)	B (mm)	g
38185	200	30	80	250



**ARMARIOS-CARROS DE HERRAMIENTAS 100% INOX / ROLLER CABINETS 100% INOX / SERVANTES À ROUES 100% INOX / WERKZEUGWAGEN 100% INOX / CASSETTIERE MOBILI 100% INOX / CARRO DE FERRAMENTAS 100% INOX / ШКАФЫ-ТЕЛЕЖКИ ДЛЯ ИНСТРУМЕНТОВ 100% НЕРЖАВЕЮЩАЯ СТАЛЬ**

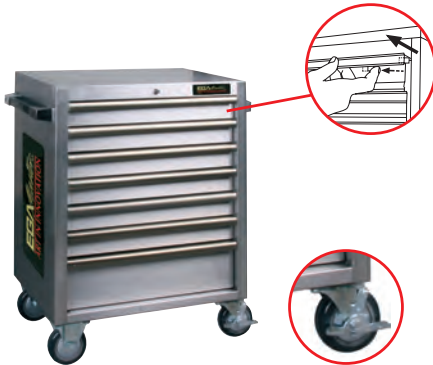

Sistema antivuelco con botón de seguridad de apertura individual por bandeja  
 Anti-overflow system with individual safety open button in each tray  
 Système anti-renversement avec bouton de sécurité d'ouverture individuelle par tiroir

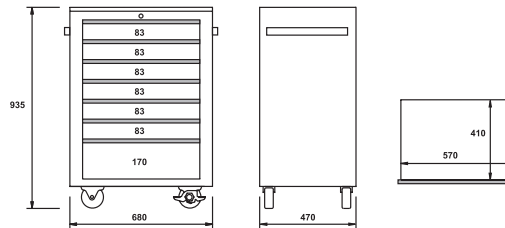

INOX

COD.	L x W x H (mm)	Material estructura / Material structure / Structure matériaux	Kg
51558	680 x 470 x 935	Inox 304	63

**ESPECIFICACIONES TÉCNICAS / TECHNICAL SPECIFICATION / DÉTAILS TECHNIQUES**

Material / Material / Matière	Exterior e interior 100% INOX / Exterior and interior 100% INOX / Extérieur et intérieur 100% INOX
Cajones con rodamientos / Ball-bearing slides / Tiroirs à roulement	7
2 ruedas fijas y 2 giratorias con freno / 2 fixed and 2 revolving with brake wheels / 2 roues fixes et 2 roues giratoires avec frein	5" x 1,5"
Capacidad cajones de altura 83 mm / Capacity in 83 mm height drawers / Capacité des tiroirs de 83 mm de haut	25 Kg
Capacidad cajones de altura 170 mm / Capacity in 170 mm height drawers / Capacité des tiroirs de 170 mm de haut	30 Kg
Capacidad de carga estática total / Total static weight capacity / Capacité totale de charge statique	320 Kg
Sistema de cierre centralizado / Central locking system / Système de fermeture centralisée	●
Asa lateral reforzada / Reinforced side handle / Poignées latérale renforcée	●
Sistema antivuelco en cada bandeja / Anti-overflow system in each drawers / Système anti-renversement dans chaque tiroir	●



Sistema antivuelco con botón de seguridad de apertura individual por bandeja  
 Anti-overflow system with individual safety open button in each tray  
 Système anti-renversement avec bouton de sécurité d'ouverture individuelle par tiroir

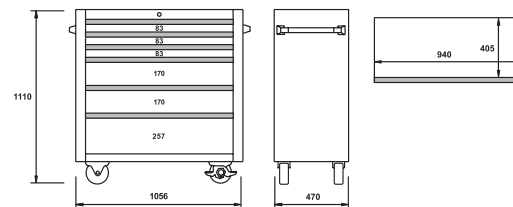

INOX

COD.	L x W x H (mm)	Material estructura / Material structure / Structure matériaux	Kg
51559	1056 x 470 x 1110	Inox 304	95

**ESPECIFICACIONES TÉCNICAS / TECHNICAL SPECIFICATION / DÉTAILS TECHNIQUES**

Material / Material / Matière	Exterior e interior 100% INOX / Exterior and interior 100% INOX / Extérieur et intérieur 100% INOX
Cajones con rodamientos / Ball-bearing slides / Tiroirs à roulement	6
2 ruedas fijas y 2 giratorias con freno / 2 fixed and 2 revolving with brake wheels / 2 roues fixes et 2 roues giratoires avec frein	5" x 1,5"
Capacidad cajones de altura 83 mm / Capacity in 83 mm height drawers / Capacité des tiroirs de 83 mm de haut	25 Kg
Capacidad cajones de altura 170 mm / Capacity in 170 mm height drawers / Capacité des tiroirs de 170 mm de haut	30 Kg
Capacidad cajones de altura 257 mm / Capacity in 257 mm height drawers / Capacité des tiroirs de 257 mm de haut	30 kg
Capacidad de carga estática total / Total static weight capacity / Capacité totale de charge statique	500 kg
Sistema de cierre centralizado / Central locking system / Système de fermeture centralisée	●
Asa lateral reforzada / Reinforced side handle / Poignées latérale renforcée	●
Sistema antivuelco en cada bandeja / Anti-overflow system in each drawers / Système anti-renversement dans chaque tiroir	●



**ARMARIOS-CARROS DE HERRAMIENTAS DE SUPERFICIES INOX\* / INOX SURFACE ROLLER CABINETS\* / SERVANTES À ROUES AVEC SURFACE INOX\* /  
 WERKZEUGWAGEN MIT INOX OBERFLÄCHE\* / CASSETTIERE MOBILI PORTAUTENSILI DI SUPERFICI INOX\* / ARMÁRIOS-CARROS DE FERRAMENTA DE SUPERFÍCIE  
 INOX\* / ШКАФЫ-ТЕЛЕЖКИ ДЛЯ ИНСТРУМЕНТОВ С ПОКРЫТИЕМ ИЗ НЕРЖАВЕЮЩЕЙ СТАЛИ\***



Sistema antivuelco con botón de seguridad de apertura individual por bandeja  
 Anti-overtum system with individual safety open button in each tray  
 Système anti-renversement avec bouton de sécurité d'ouverture individuelle par tiroir

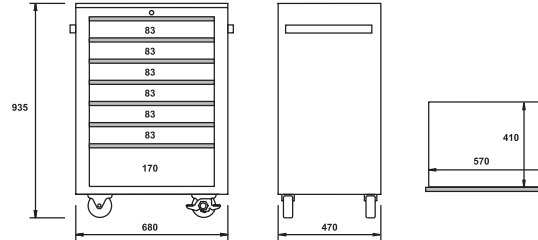

INOX

COD.	L x W x H (mm)	Material estructura / Material structure / Structure matériaux	Material ruedas / Wheel material / Matière roues	Kg
51478	680 x 470 x 935	Inox 430	Inox 304	63

**ESPECIFICACIONES TÉCNICAS / TECHNICAL SPECIFICATION / DÉTAILS TECHNIQUES**

Material* / Material* / Matière*	Exterior 100% INOX - Interior: Acero pintado - Placa fijación ruedas: Acero / Exterior 100% INOX - Interior: Painted Steel - Wheel fixing plate: Steel / Extérieur 100% INOX - Intérieur: Acier peint - Roues de fixation: Acier
Cajones con rodamientos / Ball-bearing slides / Tiroirs à roulement	7
2 ruedas fijas y 2 giratorias con freno / 2 fixed and 2 revolving with brake wheels / 2 roues fixes et 2 roues giratoires avec frein	5" x 1,5"
Capacidad cajones de altura 83 mm / Capacity in 83 mm height drawers / Capacité des tiroirs de 83 mm de haut	25 Kg
Capacidad cajones de altura 170 mm / Capacity in 170 mm height drawers / Capacité des tiroirs de 170 mm de haut	30 Kg
Capacidad de carga estática total / Total static weight capacity / Capacité totale de charge statique	320 Kg
Sistema de cierre centralizado / Central locking system / Système de fermeture centralisée	●
Asa lateral reforzada / Reinforced side handle / Poignées latérale renforcée	●
Sistema antivuelco en cada bandeja / Anti-overtum system in each drawers / Système anti-renversement dans chaque tiroir	●

**EGAMaster**  
 ART IN INNOVATION

**ARMARIOS-CARROS DE HERRAMIENTAS DE SUPERFICIES INOX\* / INOX SURFACE ROLLER CABINETS\* / SERVANTES À ROUES AVEC SURFACE INOX\* /  
 WERKZEUGWAGEN MIT INOX OBERFLÄCHE\* / CASSETTIERE MOBILI PORTAUTENSILI DI SUPERFICI INOX\* / ARMÁRIOS-CARROS DE FERRAMENTA DE SUPERFÍCIE  
 INOX\* / ШКАФЫ-ТЕЛЕЖКИ ДЛЯ ИНСТРУМЕНТОВ С ПОКРЫТИЕМ ИЗ НЕРЖАВЕЮЩЕЙ СТАЛИ\***

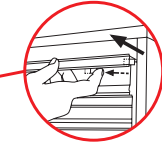

Sistema antivuelco con botón de seguridad de apertura individual por bandeja  
 Anti-overtum system with individual safety open button in each tray  
 Système anti-renversement avec bouton de sécurité d'ouverture individuelle par tiroir

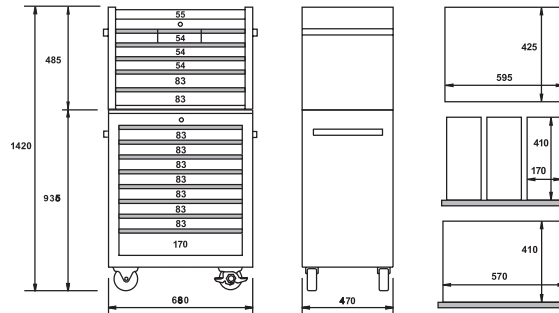

INOX

COD.	L x W x H (mm)	Material estructura / Material structure / Structure matériaux	Material ruedas / Wheel material / Matière roues	Kg
51563	680 x 470 x 1420	Inox 430	Inox 304	109

**ESPECIFICACIONES TÉCNICAS / TECHNICAL SPECIFICATION / DÉTAILS TECHNIQUES**

Material* / Material* / Matière*	Exterior 100% INOX - Interior: Acero pintado - Placa fijación ruedas: Acero / Exterior 100% INOX - Interior: Painted Steel - Wheel fixing plate: Steel / Extérieur 100% INOX - Intérieur: Acier peint - Roues de fixation: Acier
Cajones con rodamientos / Ball-bearing slides / Tiroirs à roulement	14
Tapa con doble pistón neumático / Double pneumatic absorber equipped lid / Couvercle avec double piston pneumatique	●
2 ruedas fijas y 2 giratorias con freno / 2 fixed and 2 revolving with brake wheels / 2 roues fixes et 2 roues giratoires avec frein	5" x 1,5"
Capacidad cajones 170,5 x 410 x 54 mm / Capacity in 170,5 x 410 x 54mm drawers / Capacité des tiroirs de 170,5 x 410 x 54 mm	15 kg
Capacidad cajones 570 x 410 x 54 mm / Capacity in 570 x 410 x 54 mm drawers / Capacité des tiroirs de 570 x 410 x 54 mm	25 kg
Capacidad cajones de altura 83 mm / Capacity in 83 mm height drawers / Capacité des tiroirs de 83 mm de haut	25 Kg
Capacidad cajones de altura 170 mm / Capacity in 170 mm height drawers / Capacité des tiroirs de 170 mm de haut	30 Kg
Capacidad de carga estática total / Total static weight capacity / Capacité totale de charge statique	470 kg
Sistema de cierre centralizado / Central locking system / Système de fermeture centralisée	●
Asa lateral reforzada / Reinforced side handle / Poignées latérale renforcée	●
Sistema antivuelco en cada bandeja / Anti-overtum system in each drawers / Système anti-renversement dans chaque tiroir	●

**BE SAFE...BE EFFICIENT**

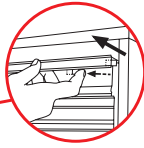

Sistema antivuelco con botón de seguridad de apertura individual por bandeja  
*Anti-overturn system with individual safety open button in each tray*  
 Système anti-renversement avec bouton de sécurité d'ouverture individuelle par tiroir

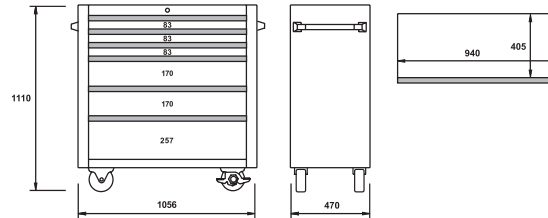

INOX

COD.	L x W x H (mm)	Material estructura / Material structure / Structure matériaux	Material ruedas / Wheel material / Matière roues	Kg
51561	1056 x 470 x 1110	Inox 430	Inox 304	95

**ESPECIFICACIONES TÉCNICAS / TECHNICAL SPECIFICATION / DÉTAILS TECHNIQUES**

Material* / Material* / Matière*	Exterior 100% INOX - Interior: Acero pintado - Placa fijación ruedas: Acero / Exterior 100% INOX - Interior: Painted Steel - Wheel fixing plate: Steel / Extérieur 100% INOX - Intérieur: Acier peint - Roues de fixation: Acier
Cajones con rodamientos / Ball-bearing slides / Tiroirs à roulement	6
2 ruedas fijas y 2 giratorias con freno / 2 fixed and 2 revolving with brake wheels / 2 roues fixes et 2 roues giratoires avec frein	5" x 1,5"
Capacidad cajones de altura 83 mm / Capacity in 83 mm height drawers / Capacité des tiroirs de 83 mm de haut	25 Kg
Capacidad cajones de altura 170 mm / Capacity in 170 mm height drawers / Capacité des tiroirs de 170 mm de haut	30 Kg
Capacidad cajones de altura 257 mm / Capacity in 257 mm height drawers / Capacité des tiroirs de 257 mm de haut	30 kg
Capacidad de carga estática total / Total static weight capacity / Capacité totale de charge statique	500 kg
Sistema de cierre centralizado / Central locking system / Système de fermeture centralisée	●
Asa lateral reforzada / Reinforced side handle / Poignées latérale renforcée	●
Sistema antivuelco en cada bandeja / Anti-overturn system in each drawers / Système anti-renversement dans chaque tiroir	●



**ARMARIOS-CARROS DE HERRAMIENTAS DE SUPERFICIES INOX\* / INOX SURFACE ROLLER CABINETS\* / SERVANTES À ROUES AVEC SURFACE INOX\* /  
 WERKZEUGWAGEN MIT INOX OBERFLÄCHE\* / CASSETTIERE MOBILI PORTAUTENSILI DI SUPERFICI INOX\* / ARMÁRIOS-CARROS DE FERRAMENTA DE SUPERFÍCIE  
 INOX\* / ШКАФЫ-ТЕЛЕЖКИ ДЛЯ ИНСТРУМЕНТОВ С ПОКРЫТИЕМ ИЗ НЕРЖАВЕЮЩЕЙ СТАЛИ\***

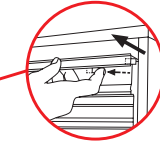

Sistema antivuelco con botón de seguridad de apertura individual por bandeja  
 Anti-ouvertum system with individual safety open button in each tray  
 Système anti-renversement avec bouton de sécurité d'ouverture individuelle par tiroir

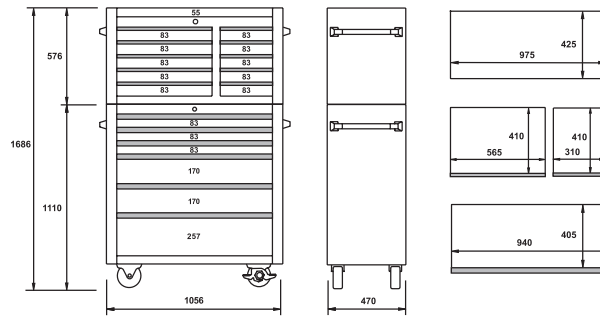

INOX

COD.	L x W x H (mm)	Material estructura / Material structure / Structure matériaux	Material ruedas / Wheel material / Matière roues	Kg
51564	1056 x 470 x 1686	Inox 430	Inox 304	168

**ESPECIFICACIONES TÉCNICAS / TECHNICAL SPECIFICATION / DÉTAILS TECHNIQUES**

Material* / Material* / Matière*	Exterior 100% INOX - Interior: Acero pintado - Placa fijación ruedas: Acero / Exterior 100% INOX - Interior: Painted Steel - Wheel fixing plate: Steel / Extérieur 100% INOX - Intérieur: Acier peint - Roues de fixation: Acier
Cajones con rodamientos / Ball-bearing slides / Tiroirs à roulement	16
2 ruedas fijas y 2 giratorias con freno / 2 fixed and 2 revolving with brake wheels / 2 roues fixes et 2 roues giratoires avec frein	5" x 1,5"
Capacidad cajones de altura 83 mm / Capacity in 83 mm height drawers / Capacité des tiroirs de 83 mm de haut	25 Kg
Capacidad cajones de altura 170 mm / Capacity in 170 mm height drawers / Capacité des tiroirs de 170 mm de haut	30 Kg
Capacidad cajones de altura 257 mm / Capacity in 257 mm height drawers / Capacité des tiroirs de 257 mm de haut	30 kg
Capacidad de carga estática total / Total static weight capacity / Capacité totale de charge statique	700 kg
Sistema de cierre centralizado / Central locking system / Système de fermeture centralisée	●
Asa lateral reforzada / Reinforced side handle / Poignées latérale renforcée	●
Sistema antivuelco en cada bandeja / Anti-ouvertum system in each drawers / Système anti-renversement dans chaque tiroir	●

**EGA Master**  
 ART IN INNOVATION

**COFRES PORTAHERRAMIENTAS DE SUPERFICIES INOX\* / INOX SURFACE TOOL CHEST\* / COFFRE À TIROIRS AVEC SURFACE INOX\* / WERKSTATTKASTEN MIT INOX OBERFLÄCHE\* / CASSETTI PORTAUTENSILI DI SUPERFICI INOX\* / BAÚ PORTA-FERRAMENTAS DE SUPERFÍCIE INOX\* / ПОРТАТИВНЫЕ ЯЩИКИ С ПОВЕРХНИЕМ ИЗ НЕРЖАВЕЮЩЕЙ СТАЛИ\***

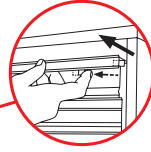

Sistema antivuelco con botón de seguridad de apertura individual por bandeja  
*Anti-overtum system with individual safety open button in each tray*  
 Système anti-renversement avec bouton de sécurité d'ouverture individuelle par tiroir

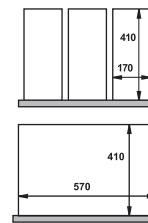
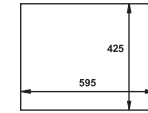
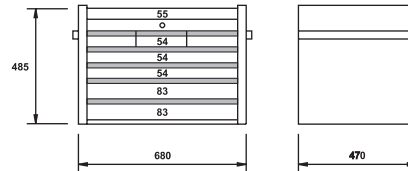

INOX

COD.	L x W x H (mm)	Material estructura / Material structure / Structure matériaux	Kg
<b>51560</b>	680 x 470 x 485	Inox 430	45,5

**ESPECIFICACIONES TÉCNICAS / TECHNICAL SPECIFICATION / DÉTAILS TECHNIQUES**

Material* / Material* / Matière*	Exterior: 100% INOX - Interior: Acero pintado / Exterior 100% INOX - Interior: Painted Steel / Extérieur 100% INOX - Intérieur: Acier peint
Cajones con rodamientos / Ball-bearing slides / Tiroirs à roulement	7
Tapa con doble pistón neumático / Double pneumatic absorber equipped lid / Couverture avec double piston pneumatique	●
Capacidad cajones 170,5 x 410 x 54 mm / Capacity in 170,5 x 410 x 54mm drawers / Capacité des tiroirs de 170,5 x 410 x 54 mm	15 kg
Capacidad cajones 570 x 410 x 54 mm / Capacity in 570 x 410 x 54 mm drawers / Capacité des tiroirs de 570 x 410 x 54 mm	25 kg
Capacidad cajones de altura 83 mm / Capacity in 83 mm height drawers / Capacité des tiroirs de 83 mm de haut	25 kg
Capacidad de carga estática total / Total static weight capacity / Capacité totale de charge statique	150 kg
Sistema de cierre centralizado / Central locking system / Système de fermeture centralisée	●
Asa lateral reforzada / Reinforced side handle / Poignées latérale renforcée	●
Sistema antivuelco en cada bandeja / Anti-overtum system in each drawers / Système anti-renversement dans chaque tiroir	●

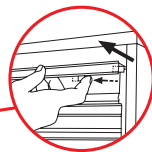

Sistema antivuelco con botón de seguridad de apertura individual por bandeja  
*Anti-overtum system with individual safety open button in each tray*  
 Système anti-renversement avec bouton de sécurité d'ouverture individuelle par tiroir

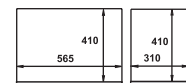
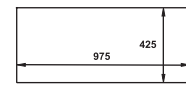
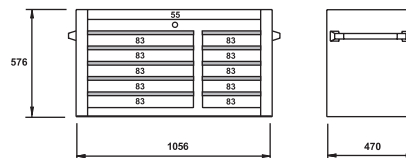

INOX

COD.	L x W x H (mm)	Material estructura / Material structure / Structure matériaux	Kg
<b>51562</b>	1056 x 470 x 576	Inox 430	95

**ESPECIFICACIONES TÉCNICAS / TECHNICAL SPECIFICATION / DÉTAILS TECHNIQUES**

Material* / Material* / Matière*	Exterior: 100% INOX - Interior: Acero pintado / Exterior 100% INOX - Interior: Painted Steel / Extérieur 100% INOX - Intérieur: Acier peint
Cajones con rodamientos / Ball-bearing slides / Tiroirs à roulement	10
Capacidad cajones de altura 83 mm / Capacity in 83 mm height drawers / Capacité des tiroirs de 83 mm de haut	25 kg
Capacidad de carga estática total / Total static weight capacity / Capacité totale de charge statique	200 kg
Sistema de cierre centralizado / Central locking system / Système de fermeture centralisée	●
Asa lateral reforzada / Reinforced side handle / Poignées latérale renforcée	●
Sistema antivuelco en cada bandeja / Anti-overtum system in each drawers / Système anti-renversement dans chaque tiroir	●



## **SHELL (Nigeria)**

*Godfrey Ekeke*  
Maintenance Planner

"EGA Master Tools are absolutely amazing tools in terms of value in safety, convenience and versatility."



**PPE**

EQUIPOS DE PROTECCIÓN INDIVIDUAL  
PERSONAL PROTECTION EQUIPMENT  
EQUIPEMENTS DE PROTECTION INDIVIDUELLE  
PERSÖNLICHE SCHUTZAUSRÜSTUNG  
DISPOSITIVI DI PROTEZIONE INDIVIDUALE  
EQUIPAMENTOS DE PROTECÇÃO INDIVIDUAL  
ПЕРСОНАЛЬНОЕ ЗАЩИТНОЕ ОБОРУДОВАНИЕ

11



**PPE**

**PROTECCIÓN RESPIRATORIA / RESPIRATORY PROTECTION / PROTECTION RESPIRATOIRE / ATEMSCUTZ / PROTEZIONE RESPIRATORIA /  
 PROTEÇÃO RESPIRATÓRIA / ЗАЩИТА ДЫХАНИЯ**

**ELECCIÓN DEL PROTECTOR RESPIRATORIO**

**Importante: limitaciones de uso**

- No debe utilizarse en atmósferas ricas en oxígeno, ni cuando la concentración de oxígeno es < 19,5 %.
- No debe utilizarse en espacios confinados como tanques, fosas, alcantarillas, zanjas o espacios poco ventilados donde pueda existir una alta concentración de contaminantes.

**Aseguramiento de la Calidad**

Sistema de Garantía de la Calidad de la producción aprobado por el Organismo de Control Notificado 0099 (AENOR).

Los ensayos de control de calidad se realizan en cada lote de acuerdo al Art. 11B de la Directiva 89/686.

Directiva  
 89/686/CEE  
 Sis. Calidad  
 Art. 11B

**Normativa**

Normas CE-EN

**Normas - Descripción**

**Aparatos de Protección Respiratoria**

- **EN 140** Medias máscaras y cuartos de máscara.
- **EN 149** Medias máscaras filtrantes de protección contra partículas (mascarillas autofiltrantes). Filtros y dispositivos absorbentes.
- **EN 143** Filtros contra partículas.
- **EN 14387** Filtros contra gases y filtros combinados.

**ELECTION OF THE RESPIRATORY PROTECTOR**

**Important: limitations of use**

- Do not use filtering devices, neither in atmospheres rich in oxygen, nor when the concentration of oxygen is < 19,5 %.
- Do not use filtering devices in confined spaces such as tanks, stills, pits, sewers, trenches or other poorly ventilated spaces where high concentrations of contaminant can be present or built rapidly.

**Quality Assurance**

Quality system guarantee of production agreed by the Notified Body 0099 (AENOR).

The quality control tests are carried out in every production according to Art.11B of 89/686 directive.

Directive  
 89/686/EEC  
 Quality Sys.  
 Art. 11B

**Standard**

CE-EN Standard

**Standard-Description**

**Respiratory Protective Devices**

- **EN 140** Half masks and quarter masks.
- **EN 149** Filtering half masks to protect against particles (dust masks).
- **EN 143** Particle Filters.
- **EN 14387** Gas Filters and combined filters.

**CHOIX DE LA PROTECTION RESPIRATOIRE**

**Important: limites d'utilisation**

- Ne doit pas s'utiliser dans les atmosphères riches en oxygène, ni quand la concentration d'oxygène est < 19,5 %.
- Ne doit pas s'utiliser dans les espaces confinés comme les citernes, les tranchées ou les espaces peu ventilés ou il peut exister une forte concentration de polluants.

**Assurance Qualité**

Système de Garantie de la Qualité de la production approuvé par l'Organisme de Contrôle Notifié 0099 (AENOR).

Les essais de contrôle de qualité se réalisent sur chaque lot conformément à l'Art.11B de la Directive 89/686.

Directive  
 89/686/CEE  
 Sys. Qualité  
 Art. 11B

**Règlementation**

Normes CE-EN

**Normes - Description**

**Appareils de Protection Respiratoire**

- **EN 140** Demi et quart de masques.
- **EN 149** Demi-masques filtrants de protection contre les particules (masques auto-filtrants). Filtres et dispositifs absorbants.
- **EN 143** Filtres contre les particules.
- **EN 14387** Filtres contre les gaz et filtres combinés.

**MASCARILLAS AUTOFILTRANTES / DISPOSABLE MASKS / MASQUES AUTO-FILTRANTS / EINWEGMASKEN / MASCHERINA AUTOFILTRANTE / MÁSCARAS AUTOFILTRANTES /  
 ОДНОРАЗОВЫЕ МАСКИ**

**Norma:**

**EN 149** Medias máscaras filtrantes de protección contra partículas (mascarillas autofiltrantes).

**Características comunes**

- Indicadas para la protección contra partículas y aerosoles sólidos o líquidos (de base acuosa u oleica).
- "D": Máscara resistente a la obstrucción en el tiempo (prueba por polvo de Dolomita) que mejora la comodidad de utilización.
- Plegable, fácil de guardar.
- Rango completo para diversas aplicaciones.
- Codificación por colores.
- Alta eficacia y poder de retención conforme a Normativa EN.
- Ajuste perfecto que mejora la seguridad y comodidad del usuario.
- Atalaje a una pieza que mejora el ajuste y la comodidad.
- Totalmente soldada. Mejora y prolonga la vida de la mascarilla.
- Antifluex, no desprende fibras. Perfecta para la industria del automóvil y la línea blanca.

**Standard:**

**EN 149** Filtering half masks to protect against particles (dust masks).

**Common characteristics**

- Suitable for the protection against particles and solid or liquid aerosols (watery or oleic base).
- "D": Mask resistant to clogging in time (test by Dolomite dust) improving comfort of use.
- Folding, easy to wear and store.
- Complete range for different applications.
- Colour coded.
- High effectiveness and retention power according to the EN Standard.
- Perfect fit that improves the security and comfort for the user.
- Harness in one piece that improves the adjustment and comfort.
- Totally welded. Improves and increases mask's life.
- Anti-fluex, it doesn't disjoin fibres, which makes it perfect for car industry and white line.

**Norme:**

**EN 149** Demi-masques filtrants de protection contre les particules (masques auto-filtrants).

**Caractéristiques communes**

- Recommandés pour la protection contre les particules et les aérosols solides ou liquides (de base aqueuse ou oléique)
- "D": Masque résistant à l'obstruction dans le temps (essai avec poussière de Dolomite) qui améliore le confort d'utilisation.
- Pliable, facile à garder.
- Rang complet pour diverses applications
- Codification par couleurs
- Haute efficacité et pouvoir de rétention conformément à la Règlementation EN.
- Réglage parfait qui améliore la sécurité et le confort de l'utilisateur.
- Attache à une pièce qui améliore le réglage et le confort.
- Totalement soudé. Améliore et prolonge la vie du masque.
- Anti-fluex, ne dégage pas de fibres. Parfait pour l'industrie de l'automobile et la ligne blanche.



**Identificación de medias máscaras filtrantes de protección contra partículas sólidas o líquidas (mascarillas autofiltrantes)**  
**Identification of disposable half masks protective against liquid and solid particles (disposable masks)**  
**Identification de demi-masques filtrants de protection contre les particules solides ou liquides (masques auto-filtrants)**

Clase / Class / Classe	Utilización / Usage / Utilisation
<b>P1</b>	Contra partículas sólidas de materia inerte hasta 4,5 x TLV <i>Against solid particles of inert matter to 4,5 x TLV</i> Contre les particules solides de matière inerte jusqu'à 4,5 x TLV
<b>P2</b>	Contra aerosoles de baja toxicidad hasta 12 x TLV <i>Against low toxicity aerosols to 12 x TLV</i> Contre les aérosols de faible toxicité jusqu'à 12 x TLV
<b>P3</b>	Contra aerosoles tóxicos hasta 50 x TLV <i>Against toxic aerosols to 50 x TLV</i> Contre les aérosols toxiques jusqu'à 50 x TLV

**Identificación símbolos autofiltrantes / Disposable masks symbols identification / Identification symboles auto-filtrants**

<b>V</b>	Válvula de exhalación <i>Exhalation valve</i> Valve d'exhalation
<b>D</b>	Máscara resistente a la obstrucción en el tiempo (prueba por polvo de Dolomita) que mejora la comodidad de utilización <i>Mask resistant to clogging in time (test by Dolomite dust) improving comfort of use</i> Masque résistant à l'obstruction dans le temps (essai avec poussière de Dolomie) qui améliore le confort d'utilisation
<b>C</b>	Carbón activo que permite captar las moléculas tóxicas de los gases/vapores <i>Active carbon which allows to collect the toxic molecules from the gases/vapours</i> Charbon actif qui permet de saisir les molécules toxiques des gaz/vapeurs
<b>NR</b>	Mascarilla limitada a una utilización para un sólo turno de trabajo <i>Dust mask is limited to single working shift use only</i> Masque limité à une utilisation pour un seul service de travail

COD.			
<b>35660</b>	P1	12	<b>D</b>

EN 149



COD.			
<b>35661</b>	P3V	12	<b>D</b>

EN 149



COD.			
<b>35662</b>	P2VC	16	<b>D</b>

EN 149



■ MÁSCARA BUCONASAL / HALF MASK / MASQUE BUCCO-NASAL / HALB MASKEN / MASCHERA BUCCO-NASALE / MEIA-MÁSCARA / РЕСПИРАТОРЫ

COD.	
35663	300

EN 140



ESPECIFICACIONES TÉCNICAS / TECHNICAL SPECIFICATION / DÉTAILS TECHNIQUES

Diseño ergonómico / Ergonomic design / Design ergonomique	●
Pliegue interior que sella la comisura de la mascarilla a la cara para mayor comodidad y hermeticidad del usuario Exhalation valve designed for low breathing resistance reducing wearer fatigue	●
Incorpore pli intérieur qui scelle le coin du masque à la face pour un plus grand confort et hermétisme pour l'utilisateur	
Material / Material / Matériau	TPE
<b>ATALAJE / HARNESS / ATTACHE</b>	
A la coronilla / Crown / Sur le crâne	●
Tamaño de rosca / Thread size / Taille de filetage	M 66X6
Ergonómico / Ergonomic / Ergonomique	●
Inyectado en una sola pieza para adaptarse a la coronilla del usuario y repartir la tensión equitativamente Injected in one piece that fits to user's crown, sharing the tension equitably	●
Injecté sur une seule pièce pour s'adapter au crâne de l'utilisateur et partager la tension équitablement	
Puntos de sujeción integrados en el cuerpo de la mascarilla para reducir riesgo de fugas Head strap retaining points are integrated to the mask body, reducing leakage risk	●
Points de fixation intégrés au corps du masque et réduction de risque de fuites	
Componentes de goma con tratamiento especial para eliminar epoxis o cualquier residuo susceptible de producir irritación en la piel Made of natural rubber with special treatment which do not produce dermatitis or hazard effects to the user avoiding the damage in the skin	●
Composants de caoutchouc avec traitement spécial pour éliminer époxys ou quelconque résidu susceptible de produire une irritation à la peau	

■ FILTROS / FILTERS / FILTRES / FILTER / FILTRI / FILTROS / ФИЛЬТРЫ

COD.	
35664	Filtro de gas Gas filter Filtre de gaz A1*
	150

EN 14387



COD.	
35665	Filtro de partículas Particles filter Filtre de particules P2
	100

EN 143



COD.	
35666	Filtro de gas + partículas Filter + particles Filtre de gaz + particules A1P3*
	150

EN 14387



COD.		
35667	<b>Filtro de gas</b> <i>Gas filter</i> <b>Filtre de gaz</b> A1B1E1	150

EN 14387



COD.		
35668	<b>Filtro de gas + partículas</b> <i>Filter + particles</i> <b>Filtre de gaz + particules</b> A1B1E1K1P3*	200

EN 14387



### Identificación de filtros / Filters identification / Identification de filtre

Clase Class Classe	Color Colour Couleur	Contaminante Contaminant Polluant	Clase Category Classe	Concentración de gas Gas concentration Concentration de Gaz	Norma Standard Norme
A		Uso frente a ciertos gases y vapores orgánicos con punto de ebullición >65° según las indicaciones del fabricante <i>For use against certain organic gases and vapours with a boiling point &gt;65°C as specified by the manufacturer</i> Usage face à certains gaz et vapeurs organiques avec point d'ébullition >65° selon les indications du fabricant	1	1000 ml/m <sup>3</sup>	EN 14387
			2	5000 ml/m <sup>3</sup>	
			3	10000 ml/m <sup>3</sup>	
B		Uso frente a ciertos gases y vapores inorgánicos, según indicación del fabricante <i>For use against certain inorganic gases and vapours as specified by the manufacturer</i> Usage face à certains gaz et vapeurs inorganiques, selon indication du fabricant	1	1000 ml/m <sup>3</sup>	EN 14387
			2	5000 ml/m <sup>3</sup>	
			3	10000 ml/m <sup>3</sup>	
E		Uso frente a dióxido de azufre y otros gases y vapores ácidos, según indicación del fabricante <i>For use against sulphur dioxide and other acid gases and vapours as specified by the manufacturer</i> Usage face au dioxyde de soufre et autres gaz et vapeurs acides, selon indication du fabricant	1	1000 ml/m <sup>3</sup>	EN 14387
			2	5000 ml/m <sup>3</sup>	
			3	10000 ml/m <sup>3</sup>	
K		Uso frente a amoníaco y derivados orgánicos del amoníaco según indicación del fabricante <i>For use against ammonia and organic ammonia derivatives as specified by the manufacturer</i> Usage face à ammoniac et dérivés organiques de l'ammoniac, selon indication du fabricant	1	1000 ml/m <sup>3</sup>	EN 14387
			2	5000 ml/m <sup>3</sup>	
			3	10000 ml/m <sup>3</sup>	
P		Partículas y aerosoles / <i>Particles and aerosols</i> / Particules et aérosols	1	1000 ml/m <sup>3</sup>	EN 143
			2	5000 ml/m <sup>3</sup>	
			3	10000 ml/m <sup>3</sup>	

### Identificación símbolos filtros / Filters symbols identification / Identification symboles filtre

Clase / Class / Classe	Descripción / Description / Description
NR	Filtro limitado a una utilización para un sólo turno de trabajo <i>Dust mask is limited to single working shift use only</i> Filtre limité à une utilisation pour un seul service de travail



■ **PROTECCIÓN OCULAR / EYE PROTECTION / PROTECTION OCULAIRE / AUGENSCHUTZ / PROTEZIONE OCULARE / PROTEÇÃO OCULAR / ЗАЩИТА ГЛАЗ**

Normas CE-EN (Normas de base) / CE-EN Standard (Normative references) / Normes CE-EN (Normes de base)	
<b>EN 166</b>	Protección individual de los ojos. Especificaciones / <i>Personal eye-protection. Requirements</i> / Protection individuelle des yeux. Spécifications
<b>EN 167</b>	Protección individual de los ojos. Métodos de ensayos ópticos <i>Personal eye-protection. Optical test methods</i> Protection individuelle des yeux. Méthodes d'essais optiques
<b>EN 169</b>	Protección individual de los ojos. Filtros para soldadura y técnicas relacionadas. Especificaciones del coeficiente de transmisión (transmitancia) y uso recomendado <i>Personal eye-protection. Filters for welding and related techniques. Transmittance requirements and recommended usage</i> Protection individuelle des yeux. Filtres pour soudure et techniques mises en relations. Spécifications du coefficient de transmission et usage recommandé
<b>EN 170</b>	Protección individual de los ojos. Filtros para ultravioleta. Especificaciones del coeficiente de transmisión (transmitancia) y uso recomendado <i>Personal eye-protection. Ultraviolet filters. Transmittance requirements and recommended use</i> Protection individuelle des yeux. Filtres pour ultraviolet. Spécifications du coefficient de transmission et usage recommandé
<b>EN 171</b>	Protección individual de los ojos. Filtros para el infrarrojo. Especificaciones del coeficiente de transmisión (transmitancia) y uso recomendado <i>Personal eye-protection. Infrared filters. Transmittance requirements and recommended use</i> Protection individuelle des yeux. Filtres pour infrarouge. Spécifications du coefficient de transmission et usage recommandé
<b>EN 172</b>	Protección individual de los ojos. Filtros de protección solar para uso laboral <i>Personal eye-protection. Sunglare filters for industrial use</i> Protection individuelle des yeux. Filtres de protection solaire pour usage professionnel
<b>EN 175</b>	Protección individual de los ojos. Equipos para la protección de los ojos y la cara durante la soldadura y técnicas afines <i>Personal eye-protection. Equipment for eye and face protection during welding and allied processes</i> Protection individuelle des yeux. Matériel pour la protection des yeux et du visage durant la soudure et les techniques communes
<b>EN 379</b>	Protección individual de los ojos. Filtros automáticos para soldadura <i>Personal eye-protection. Automatic filters for welding</i> Protection individuelle des yeux. Filtres automatiques pour soudure
<b>EN 1731</b>	Protección individual de los ojos. Protectores oculares y faciales de malla <i>Personal eye-protection. Eye and face mesh protectors</i> Protection individuelle des yeux. Protecteurs oculaires et faciaux en maille
<b>EN 1598</b>	Higiene y seguridad en el soldeo y procesos afines. Cortinas, lamas y pantallas transparentes para procesos de soldeo por arco <i>Hygiene and security in welding and similar processes. Curtains, slats and transparent screens for bow-welding processes</i> Hygiène et sécurité dans la soudure et les processus communs. Rideaux, et écrans transparents pour les processus de soudage par arc

**EN 172**

**Filtros de protección solar para uso laboral**

- Protegen al ojo humano frente a una radiación excesiva.
- Aumentan la comodidad y la percepción visual.
- La correcta elección del filtro dependerá de:
  - El nivel de iluminación ambiental.
  - La sensibilidad individual al deslumbramiento.
- Además de una cierta absorción de la radiación visible los filtros deben asegurar:
  - La protección del ojo en las regiones espectrales ultravioletas.
  - La protección (dependiendo de cada situación) de las infrarrojas.

**Elección del protector ocular**

La selección de un protector ocular adecuado para un riesgo determinado es de vital importancia. De no llevar a cabo la apropiada, los efectos sobre el ojo del usuario pueden variar desde una simple molestia a graves lesiones o pérdida de visión.  
 "Asegúrese de que las gafas de seguridad que utiliza han sido ensayadas y son conformes al apartado 7.1.2. Requisitos ópticos de la norma EN 166. Si están ensayadas, el Certificado CE de Tipo, indicará la Calidad Óptica X, y que es conforme a la EN 166, es decir, a todos los apartados de la norma".

**EN 172**

**Sunglare filters for industrial use**

- Protect human eye from extremely bright conditions.
- Increase comfort and visual perception.
- The right filter choice will depend on:
  - The level of environment lighting.
  - The self sensibility to the blinding.
- Apart from some absorption of the brightness, the filters must ensure:
  - The eye protection in ultraviolet spectral areas.
  - The protection (depending on the situation) to the infrareds.

**Choice of the eye protector**

Selecting an appropriate eye protection for a given risk is vital. If not performed properly, the effects on the user's eye can range from a nuisance to serious injury or loss of vision.  
 "Be sure that the spectacles you handle have been tested and the meet with the point 7.1.2. Optical requirements on the Standard EN 166. If so, on the CE Type certificate, it will be shown the Optical Quality X, and that it is according to the EN 166, that means, to all the points of the Standard".

**EN 172**

**Filtres de protection solaire pour usage au travail**

- Protègent l'œil humain face à la radiation excessive.
- Amplifient le confort et la perception visuelle.
- Le choix correcte du filtre dépendra de:
  - Le niveau d'éclairage environnemental.
  - La sensibilité individuelle de l'éblouissement.
- En plus d'une certaine absorption de la radiation visible les filtres doivent assurer:
  - La protection de l'œil sur les zones spectrales ultraviolettes.
  - La protection (en fonction de cha que situation) aux infrarouges.

**Choix de la protection oculaire**

Le choix d'un protecteur oculaire approprié pour un risque déterminé est primordial. Dans le cas ou le choix est incorrecte, les effets sur l'œil de l'utilisateur peuvent varier d'une simple gêne à de graves lésions ou perte de vision.  
 "Assurez-vous que les lunettes de sécurité que vous utilisez ont été testées et sont conformes à la section 7.1.2. Conditions requises de la norme EN 166. Si elles ont été testées, le Certificat CE du Type, indiquera la Qualité Optique X, et qu'il est conforme à la EN 166, c'est-à-dire, à toutes les sections de la norme".

**Símbolos de Resistencia Mecánica / Symbols for Mechanical Strength / Symboles de Résistance Mécanique**

S

Solidez incrementada, resistente a una bola de 22 mm y 43 gr a 12 m/s  
*Increased robustness, resistant to a 22mm and 43gr ball to 12m/s*  
 Solidité augmentée, résistance à une boule de 22 mm et 43 gr à 12 m/s

**Impacto de partículas a alta velocidad / Impacts of high-speed particles / Impact de particules à haute vitesse**

A

Impactos de alta energía, resistente a una bola de 6 mm y 0,86 gr a 190 m/s  
*High energy impacts, resistant to a 6mm and 0,86gr ball to 190m/s*  
 Impacts haute énergie, résistance à une boule de 6 mm et 0,86 gr à 190 m/s

B

Impactos de media energía, resistente a una bola de 6 mm y 0,86 gr a 120 m/s  
*Medium energy impacts, resistant to a 6mm and 0,86gr ball to 120m/s*  
 Impacts moyenne énergie, résistance à une boule de 6 mm et 0,86 gr à 120 m/s

F

Impactos de baja energía, resistente a una bola de 6 mm y 0,86 gr a 45 m/s  
*Low energy impacts, resistant to a 6mm and 0,86gr ball to 45m/s*  
 Impacts basse énergie, résistance à une boule de 6 mm et 0,86 gr à 45 m/s

**Impacto de partículas a alta velocidad y a temperaturas extremas / Impacts of high-speed particles + Extreme Temperatures  
 Impact de particules à haute vitesse et à des températures extrêmes**

AT

Impactos de alta energía a 190 m/s + Temperaturas extremas  
*High energy impacts, 190m/s + Extreme temperatures*  
 Impacts haute énergie à 190 m/s + Températures extrêmes

BT

Impactos de media energía a 120 m/s + Temperaturas extremas  
*Medium energy impacts, 120m/s + Extreme temperatures*  
 Impacts moyenne énergie à 120 m/s + Températures extrêmes

FT

Impactos de baja energía a 45 m/s + Temperaturas extremas  
*Low energy impacts, 45m/s + Extreme temperatures*  
 Impacts basse énergie à 45 m/s + Températures extrêmes

**Riesgos cubiertos / Covered risk / Risques couverts**

K

Resistencia al deterioro superficial por partículas finas  
*Resistance to the surface damage by fine particles*  
 Résistance à la détérioration superficielle par particules fines

N

Resistencia al empañamiento / *Resistance to the fogging of oculars* / Résistance à la buée

**Símbolos de campos de uso / Symbols for fields of use / Symboles de champs d'application**

3

Gotas y salpicaduras de líquidos / *Liquid droplets* / Gouttes et projections de liquides

4

Partículas de polvo gruesas / *Large dust particles* / Particules de poussière épaisse

5

Gas y partículas de polvo finas / *Gas and fine dust particles* / Gaz et particules de poussière fine

8

Arco eléctrico de cortocircuito / *Short circuit electric arc* / Arc électrique de court-circuit

9

Metales fundidos, sólidos candentes / *Molten metals, hot solids* / Métaux fondus, solides brûlants

**Símbolos de Clase Óptica / Optical Class Symbols / Symboles de Classe Optique**

1

Trabajos Continuos. Potencia refractiva esférica ± 0,06  
*Continuous work. Spherical refractive power ± 0,06*  
 Travaux Continues. Puissance réfractive sphérique ± 0,06

2

Trabajos Intermitentes. Potencia refractiva esférica ± 0,12.  
*Intermittent work. Spherical refractive power ± 0,12*  
 Travaux Intermittents. Puissance réfractive sphérique ± 0,12

3

Trabajos ocasionales. Potencia refractiva esférica ± 0,25  
*Sporadic work. Spherical refractive power ± 0,25*  
 Travaux Occasionnels. Puissance réfractive sphérique ± 0,25

**■ Gafa policarbonato / POLYCARBONATE GLASSES / LUNETTES POLYCARBONATE / POLYCARBONAT BRILLE / OCCHIALI POLYCARBONATO / ÓCULOS POLYCARBONATO / ПОЛИКАРБОНАТНЫЕ ОЧКИ**

**ESPECIFICACIONES TÉCNICAS / TECHNICAL SPECIFICATION / DÉTAILS TECHNIQUES**

Gafas de policarbonato monobloque / <i>Polycarbonate single lens glasses</i> Lunettes de polycarbonate monobloc	●
Patillas tipo espátula planas y flexibles / <i>Soft flat spatula type arms</i> Pates type spatule plates et flexibles	●
Nariz policarbonato integrado / <i>Integrated polycarbonate nose</i> Nez polycarbonate intégré	●
Fácil uso con casco de obra y cascos antiruido / <i>Easy to use with safety helmet and ear defender</i> Usage facile avec casques de chantier et casques anti-bruit	●
Protecciones laterales / <i>Lateral protection</i> / Protections latérales	●
Ocular con tratamiento antirrayado / <i>Scratch-resistant</i> Oculaire avec traitement anti-rayure	●

COD.



35671

100

EN 166, EN 170



**CAMPO DE APLICACIÓN / APPLICATION FIELD / CHAMP D'APPLICATION**

Polycarbonato incoloro antirrayado: riesgo mecánico no especificado. Partículas volando  
*Clear polycarbonate antiscratch: unspecified mechanical hazards (flying particle)*  
 Polycarbonate incolore anti-rayure: risque mécanique non spécifiée. Particules s'évaporant  
 Resistente a impactos de baja energía (45 m/s) / *Resistant to low energy impacts (45m/s)*  
 Résistant aux impacts à base énergie (45 m/s)

COD.



35672

100

EN 166, EN 172



**CAMPO DE APLICACIÓN / APPLICATION FIELD / CHAMP D'APPLICATION**

Polycarbonato gris antirrayado: protección solar para uso laboral. UV400 - Contra radiación ultravioleta  
*Grey polycarbonate antiscratch: sunglare filters for industrial use. UV400 - Against UV radiation*  
 Polycarbonate gris anti-rayure: protection solaire pour usage professionnel UV400 - Contre radiation ultraviolette  
 Resistente a impactos de baja energía (45 m/s) / *Resistant to low energy impacts (45m/s)*  
 Résistant aux impacts à base énergie (45 m/s)

■ **GAFAS POLICARBONATO AJUSTABLES / ADJUSTABLE POLYCARBONATE GLASSES / LUNETTES POLYCARBONATE RÉGLABLES / JUSTIERBARE POLYCARBONAT BRILLE / OCCHIALI REGOLABILI POLICARBONATO / ÓCULOS POLICARBONATO AJUSTÁVEIS / РЕГУЛИРУЕМЫЕ ПОЛИКАРБОНАТНЫЕ ОЧКИ**

**ESPECIFICACIONES TÉCNICAS / TECHNICAL SPECIFICATION / DÉTAILS TECHNIQUES**

Gafas de policarbonato monobloque / *Polycarbonate single lens glasses*  
 Lunettes de polycarbonate monobloc

●

Patillas nylon abatibles y ajustables / *Adjustable and tilting nylon arms*  
 Pates nylon inclinables et réglables

●

Conteras espatuladas / *Spatula tips* / Branche en forme de spatule

●

Nariz flexible PVC extra comodidad / *Extra comfort integrated PVC nose piece*  
 Nez flexible PVC extra confort

●

Protecciones laterales / *Side protection* / Protections latérales

●

COD.



100

35673

EN 166, EN 170



**CAMPO DE APLICACIÓN / APPLICATION FIELD / CHAMP D'APPLICATION**

Polycarbonato incoloro antirrayado y antivaho: riesgo mecánico no especificado. Partículas volando  
*Clear polycarbonate antiscratch and antifog: unspecified mechanical hazards (flying particle)*  
 Polycarbonato incoloro anti-rayure et anti-vapeur: risque mécanique non spécifiée. Particules s'évaporant

Resistente a impactos de baja energía (45 m/s) / *Resistant to low energy impacts (45m/s)*

Résistant aux impacts à base énergie (45 m/s)

COD.



100

35674

EN 166, EN 172



**CAMPO DE APLICACIÓN / APPLICATION FIELD / CHAMP D'APPLICATION**

Polycarbonato gris antirrayado y antivaho: protección solar para uso laboral. UV400 - Contra radiación ultravioleta  
*Grey polycarbonate antiscratch and antifog: sunglare filters for industrial use. UV400 - Against UV radiation*  
 Polycarbonato gris anti-rayure et anti-vapeur: protection solaire pour usage professionnel UV400 - Contre radiation ultraviolette

Resistente a impactos de baja energía (45 m/s) / *Resistant to low energy impacts (45m/s)*

Résistant aux impacts à base énergie (45 m/s)

■ PROTECCIÓN AUDITIVA / EAR PROTECTION / PROTECTION AUDITIVE / GEHÖRSCHUTZ / PROTEZIONE AUDITIVA / PROTECÇÃO AUDITIVA / ЗАЩИТА УШЕЙ

Normas CE-EN CE-EN Standard Normes CE-EN	Valores / Values / Valeurs
<b>Exigencias Generales y Métodos de Ensayo / General requirements and Testing / Exigences Générales et Méthodes d'Essai</b>	
EN 352-1	Protectores auditivos: orejeras / <i>Hearing protectors: ear-muffs</i> / Protecteurs auditifs: casque antibruit
EN 352-2	Protectores auditivos: tapones / <i>Hearing protectors: ear plugs</i> / Protecteurs auditifs: bouchons d'oreilles
EN 352-3	Protectores auditivos: orejeras acopladas a un casco de protección <i>Hearing protectors: ear muffs attached to an industrial safety helmet</i> Protecteurs auditifs: serre-têtes montés sur casques de protection
<b>Protectores de oído / Hearing protectors / Protecteurs d'oreilles</b>	
EN 352-4 / A1	Protectores auditivos: orejeras independientes de nivel / <i>Hearing protectors: level dependent ear-muffs</i> Protecteurs auditifs: serre-têtes à atténuation indépendantes de niveau
EN 352-5	Protectores auditivos: orejeras con reducción activa de ruido / <i>Hearing protectors: active noise reduction ear-muffs</i> Protecteurs auditifs: serre-têtes avec atténuation active du bruit
EN 352-6	Protectores auditivos: orejeras con entrada eléctrica de audio / <i>Hearing protectors: ear-muff with electrical audio input</i> Protecteurs auditifs: serre-têtes avec entrée audio-électrique
EN 352-7	Protectores auditivos: tapones dependientes de nivel / <i>Hearing protectors: level dependent ear-plugs</i> Protecteurs auditifs: bouchons d'oreilles à atténuation dépendante de niveau
EN 352-8	Protectores auditivos: orejeras con audio de entretenimiento / <i>Hearing protectors: entertainment audio ear-muffs</i> Protecteurs auditifs: serre-têtes équipés d'un dispositif audio de divertissement
<b>Documento Guía para los protectores de oído / Guidance document for each protectors / Document Guide pour les protecteurs d'oreille</b>	
EN 458	Protectores auditivos: selección, uso, precauciones de empleo y mantenimiento <i>Hearing protectors: selection, use, care and maintenance</i> / Auditifs: sélection, utilisation, précautions d'emploi et entretien

Valores límite de exposición y acciones / Exposure limit values and actions / Valeurs limite d'exposition et d'actions		
	Valores / Values / Valeurs	Acciones / Actions / Actions
Valores límite de exposición <i>Exposure limit values</i> Valeurs limite d'exposition	LEX, 8h = 87 dB (A) y Ppico / Ppeak / PPic = 200 Pa (1)	En ningún caso se deben superar los valores límites de exposición <i>Exposure limit values must not be exceeded</i> Il ne faut en aucun cas dépasser les valeurs limites d'exposition
Valores superiores de exposición <i>Exposure upper values</i> Valeurs supérieurs d'exposition	LEX, 8h = 85 dB (A) y Ppico / Ppeak / PPic = 140 Pa (2)	Se utilizarán protectores auditivos. Obligatorio <i>Ear protectors must be used. Compulsory</i> Il faut utiliser des protecteurs auditifs. Obligatoires
Valores inferiores de exposición <i>Exposure lower values</i> Valeurs inférieurs d'exposition	LEX, 8h = 80 dB (A) y Ppico / Ppeak / PPic = 112 Pa (3)	El empresario pondrá a disposición de los trabajadores protectores auditivos. Opcionales <i>Manager could give worker ear protectors. Optional</i> Le chef d'entreprise mettra à disposition des travailleurs des protecteurs auditifs. Optionnels

#### Elección del protector auditivo

Según la Directiva 2003/10/CE del 06/05/2003, publicada el 15/02/2003 y aplicable a partir de 2006, los usuarios dispondrán del protector auditivo adecuado a partir del ruido constante de 80 dB. Más allá de este umbral de seguridad podrían aparecer lesiones.

#### Indispensable para conocer el protector auditivo:

- Conocer la intensidad del ruido.
- Conocer el SNR del protector auditivo.

#### Cálculo para elegir el protector más idóneo:

$$\begin{array}{r} \text{ruido: } 100 \text{ dB} \\ - \\ \text{snr: } 27 \text{ dB} \\ \hline 73 \text{ dB} * \end{array}$$

\* Protección adecuada a menos de 80 dB.



No descender de 65 dB  
Riesgo de sobreprotección

#### Choice of the ear protector

According to the Directive 2003/10/EC of the 06/05/2003, published the 15/02/2003 and applicable from 2006, the users will have the appropriate ear protector up to the constant noise of 80 dB. Beyond this security limit could appear injuries.

#### Essential to know the ear protector:

- Know the noise intensity.
- Know the SNR of the ear protector.

#### Calculation to choose the most suitable protector:

$$\begin{array}{r} \text{noise: } 100 \text{ dB} \\ - \\ \text{snr: } 27 \text{ dB} \\ \hline 73 \text{ dB} * \end{array}$$

\* Suitable protection at less than 80 dB.



No go down from 65 dB  
Overprotection risk

#### Choix du protecteur auditif

Selon la directive 2003/10/CE du 06/05/2003, publiée le 15/02/2003 et applicable à partir de 2006, les usagers disposeront du protecteur auditif adapté à partir d'un bruit constant de 80 dB. Au-delà de ce seuil de sécurité des lésions peuvent apparaître.

#### Indispensable pour connaître le protecteur auditif :

- Connaître l'intensité du bruit.
- Connaître le SNR du protecteur auditif.

#### Calcul pour choisir le protecteur le mieux adapté:

$$\begin{array}{r} \text{bruit : } 100 \text{ dB} \\ - \\ \text{snr: } 27 \text{ dB} \\ \hline 73 \text{ dB} * \end{array}$$

\* Protection adaptée à moins de 80 dB.



Ne pas passer sous la barre de 65dB  
Risque de surprotection



■ AURICULARES / EAR-MUFFS / CASQUES ANTIBRUIT / OHRENSCHÜTZER / CUFFIE / AURICULARES / НАУШНИКИ

COD.		
35675	30 dB	210

EN 352-1



■ ACCESORIOS / ACCESSORIES / ACCESSOIRES / ERSATZTEILE / ACCESSORI / ACESSORIOS / ЗАПАСНЫЕ ЧАСТИ

COD.		
35676	Almohadillas para auricular / <i>Headphone pads</i> Coussinet pour casque	1 par / pair / paire



COD.		
35677	Foam interior para auricular / <i>Headphone interior foam</i> Mousse intérieure pour casque	1 par / pair / paire



ESPECIFICACIONES TÉCNICAS / TECHNICAL SPECIFICATION / DÉTAILS TECHNIQUES

Indicados para puestos de trabajo con alto nivel de exposición al ruido / <i>Suitable for working positions with high level of noise exposure</i> Recommandés pour les postes de travail avec un haut niveau d'exposition au bruit	●
Excelente atenuación / <i>Excellent attenuation</i> / Excellente atténuation	●
Máxima comodidad / <i>Maximum comfort</i> / Confort maximum	●
Almohadillas de PVC especial / <i>Foam headband made from special PVC</i> / Coussinets en PVC spécial	●
Arnés de fibra de vidrio ajustable / <i>Adjustable glass fibre Nylon harness</i> / Harnais en fibre de verre réglable	●
Extensión longitudinal de adaptación / <i>Length adjustment headband</i> / Longueur du serre-tête réglable	●
Cazoletas giratorias en todas direcciones / <i>Ear Cups can rotate in all directions</i> / Coquilles tournantes dans tous les sens	●

DATOS DE ATENUACIÓN / ATTENUATION INFORMATION / DONNÉES D'ATTÉNUATION  
 EN 352-1

Almohadilla con arnés / <i>Foam headband with harness</i> / Coussinet avec harnais								
Frecuencia / <i>Frequency</i> / Fréquence (Hz)	63	125	250	500	1000	2000	4000	8000
Atenuación / <i>Attenuation</i> / Atténuation (dB)	18,3	15,8	20,4	29,6	35,8	34,8	35,7	39,5
Desviación Standard / <i>Standard Deviation</i> / Déviation Standard (dB)	4,2	3,0	2,3	2,6	2,5	4,0	4,1	5,0
Protección Asumida / <i>Assumed Protection</i> / Protection Garantie (dB)	14,1	12,8	18,2	27,0	33,3	30,8	31,6	34,4
H = 32,2 dB    M = 27,7 dB    L = 19,8 dB    SNR = 30 dB								

■ PROTECCIÓN DE LA CABEZA / HEAD PROTECTION / PROTECTION DE LA TÊTE / KOPFSCHUTZ / PROTEZIONE DELLA TESTA / PROTEÇÃO DE CABEÇA / ЗАЩИТА ГОЛОВЫ

Normas CE-EN CE-EN Standard Normes CE-EN	Descripción / Description / Description
<b>Cascos industriales / Industrial helmets / Casques industriels</b>	
EN 397	Cascos de protección para la industria / Protection helmets for the industry / Casques de protection pour l'industrie
EN 50365	Cascos eléctricamente aislantes para la utilización en instalaciones de baja tensión Electrically isolating helmets for the usage in low tension installations Casques électriquement isolants utilisés pour l'utilisation dans les installations sous tension
EN 812	Cascos de protección contra golpes para la industria / Protection helmets against shocks for industry Casquettes de protection anti-heurt pour l'industrie
<b>Cascos de protección / Protection helmets / Casques de protection</b>	
EN 13087-1	Condiciones y acondicionamiento / Conditions and conditioning / Conditions et conditionnement
EN 13087-2	Absorción de choques / Impacts absorption / Absorptions des chocs
EN 13087-3	Resistencia a la perforación / Resistance to the perforation / Résistance à la pénétration
EN 13087-4	Eficacia del sistema de retención / Retention system efficiency / Efficacité du système de rétention
EN 13087-5	Resistencia del sistema de retención / Resistance to the retention system / Résistance du système de rétention
EN 13087-6	Campo de visión / Field of vision / Champ de vision
EN 13087-7	Resistencia a la llama / Flame retardant / Résistance à la flamme
EN 13087-8	Propiedades eléctricas / Electrical properties / Propriétés électriques
EN 13087-10	Resistencia al calor radiante / Resistant to the radiant heat / Résistance à la chaleur radiante



■ CASCO / HELMET / CASQUE / HELM / ELMETTO / САРАСЕТЕ / ШЛЕМ

COD.	
<b>35678</b>	340

EN 397

ESPECIFICACIONES TÉCNICAS / TECHNICAL SPECIFICATION / DÉTAILS TECHNIQUES	
Ventilación / Ventilation / Ventilation	●
Visera / Cap / Visiere	●
Ruleta reguladora / Regulatory roulette / Roulette regulatrice	●

COD.	
<b>35679</b>	340

EN 397 / EN 50365

ESPECIFICACIONES TÉCNICAS / TECHNICAL SPECIFICATION / DÉTAILS TECHNIQUES	
Ventilación / Ventilation / Ventilation	-
Visera / Cap / Visiere	●
Ruleta reguladora / Regulatory roulette / Roulette regulatrice	●



**Características**

- Casco de protección, con una visera corta a lo largo, destinado a trabajos de altura en el campo de la construcción, obras públicas e industria.
- Formado por un casco y un arnés.

**Casco formado por:**

- Casco moldeado bajo presión de A.B.S.
- Portalámparas integrado.
- Modelos con (Cod. 35678) o sin (Cod. 35679) ventilación.
- Resistente a bajas temperaturas, -30 °C.
- Aislamiento eléctrico para los modelos sin ventilación (EBT). Símbolo 440 V. - Cod. 35679.
- Casco eléctricamente aislante. - Cod. 35679.
- Utilizados simultáneamente con otros equipos de protección eléctricamente aislantes, previenen del paso de una corriente peligrosa a través de las personas entrando por la cabeza. Válido para modelos sin ventilación.
- Resistente a salpicaduras de metales fundidos.
- Duración de la utilización: 48 meses.
- Válido para su uso con el adaptador para auricular Cod. 35682.

**Arnés compuesto por:**

- Un arnés textil con 4 puntos de fijación.
- Un adaptador de cabeza de polietileno de baja densidad ajustable desde 53-63 cm.
- Incorpora una maneta autobloqueante en la parte posterior de la nuca y una sudadera de confort de 32 cm.

**Characteristics**

- *Safety helmet, with a short cap made for working at heights, in the buildings, public works and industry fields.*
- *Formed by a helmet and a harness.*

**Helmet formed by:**

- *Helmet molded under A.B.S pressure.*
- *Lamp socket integrated.*
- *Models with (Cod. 35678) or without (Cod. 35679) ventilation.*
- *Resistant to low temperatures, -30°C.*
- *Electrical isolation for models without ventilation(EBT). 440 V Symbol - Cod. 35679.*
- *Electrically insulating helmet - Cod. 35679*
- *Used in conjunction with other electrically insulating protective equipment prevent dangerous current from passing through persons via their head. Valid for the model without ventilation.*
- *Resistant to molten metals.*
- *Usage duration: 48 months.*
- *Valid for the use with the ear muff adaptor Cod. 35682.*

**Harness formed by:**

- *A textile harness with 4 fixing points.*
- *A low density polythene head adapter adjustable from 53-63cm.*
- *Includes a lever on the back of the neck locking and a comfort sweatshirt of 32cm.*

**Caractéristiques**

- Casque de protection, avec une visière courte autour, destinée aux travaux en hauteur, dans le domaine de la construction, travaux publics et en industrie.
- Composé d'un casque et d'un harnais.

**Casque composé de:**

- Casque moulé sous pression en ABS.
- Douille intégrée.
- Modèles avec (cod 35678) ou sans (Cod. 35679) ventilation.
- Résistants aux températures basses, de -30°
- Isolation thermique pour les modèles non ventilés (EBT). Symbole 440V - Cod. 35679.
- Casque électriquement isolant - Cod. 35679.
- Utilisés simultanément avec d'autres équipements de protection électriquement isolants, empêchant les courants dangereux de traverser les personnes par la tête. Valable pour les modèles sans ventilation.
- Résistant aux projections de métal en fusion.
- Durée d'utilisation: 48 mois.
- Valable pour être utilisé avec un adaptateur pour écouteur Cod. 35682.

**Harnais composé de:**

- Un harnais textile avec 4 points de fixation.
- Un tour tête en polyéthylène de basse densité réglable de 53-63 cm.
- Une poignée antiblocage est incorporée derrière la nuque ainsi qu'un bandeau anti-sueur de 32 cm.

■ ACCESORIOS / ACCESSORIES / ACCESSOIRES / ERSATZTEILE / ACCESSORI / ACESSORIOS / ЗАПАСНЫЕ ЧАСТИ

COD.			
35682	27 dB	250	Auricular / Ear-muffs / Casque

EN 352-3

ESPECIFICACIONES TÉCNICAS / TECHNICAL SPECIFICATION / DÉTAILS TECHNIQUES

Cazoletas ajustables en altura <i>Cups adjustable in height</i>	•
Coquilles réglables en hauteur	
Cazoletas giratorias en todas las direcciones <i>Ear cups can rotate in all directions</i>	•
Coquilles giratoires dans tous les sens	
Adaptador a casco <i>Helmet adaptor</i>	ABS
Adaptateur pour casque	
Cazoletas / Cups / Coquilles	ABS

COD.	
35681	Visor policarbonato incoloro <i>Colourless polycarbonate visor</i> Visière polycarbonate Incolore

EN 166

COD.	
35680	Adaptador a casco screen holder <i>Screen holder helmet adapter</i> Adaptateur à casque screen holder

ESPECIFICACIONES TÉCNICAS / TECHNICAL SPECIFICATION / DÉTAILS TECHNIQUES

Visor policarbonato incoloro + screen holder a casco <i>Colourless polycarbonate visor + helmet screen holder</i>	•
Visière polycarbonate incolore + screen holder à casque	
Visor de protección facial y adaptador de perfil ajustable en longitud <i>Face protection visor and length adjustable</i>	•
Visière de protection faciale y adaptateur de profil réglable en longueur	
Protección contra pequeñas salpicaduras de líquido <i>Protection against small liquid droplets</i>	•
Protection contre les petites projections de liquide	
Protección contra impactos a baja energía (45 m/s) <i>Protection against low energy impacts (45m/s)</i>	•
Protection contre les impacts basse énergie (45 m/s)	
Peso visor + screen holder <i>Visor + screen holder weight</i>	175 gr
Poids de la visière + screen holder	
Adaptador / Adapter / Adaptateur Cod. 35680	ABS
Visor / Visor / Visière Cod. 35681	Policarbonato incoloro <i>Colourless Polycarbonate</i> Polycarbonate incolore







COD.	CAP.	PAG.	COD.	CAP.	PAG.	COD.	CAP.	PAG.	COD.	CAP.	PAG.	COD.	CAP.	PAG.	COD.	CAP.	PAG.	COD.	CAP.	PAG.	COD.	CAP.	PAG.
38404	10	387	38502	10	394	38596	10	385	38724	10	400	38818	10	403	56635	7	338	56729	7	338	56823	7	339
38405	10	387	38503	10	394	38597	10	385	38725	10	400	38819	10	403	56636	7	338	56730	7	338	56824	7	339
38406	10	387	38504	10	394	38598	10	385	38726	10	400	38820	10	403	56637	7	338	56731	7	338	56825	7	339
38407	10	387	38505	10	394	38599	10	385	38727	10	400	38821	10	403	56638	7	338	56732	7	338	56826	7	339
38408	10	387	38506	10	394	38600	10	385	38728	10	400	38822	10	403	56639	7	338	56733	7	338	56827	7	339
38409	10	387	38507	10	394	38601	10	385	38729	10	400	38824	10	398	56640	7	338	56734	7	338	56828	7	339
38410	10	387	38508	10	394	38602	10	385	38730	10	400	38825	10	398	56641	7	338	56735	7	338	56829	7	339
38411	10	387	38509	10	394	38603	10	385	38731	10	400	38826	10	403	56642	7	338	56736	7	338	56830	7	339
38412	10	387	38510	10	394	38604	10	385	38732	10	400	38827	10	403	56643	7	338	56737	7	338	56831	7	339
38413	10	387	38511	10	394	38610	10	404	38733	10	400	38828	10	403	56644	7	338	56738	7	338	56832	7	339
38414	10	387	38512	10	394	38611	10	404	38734	10	401	38829	10	398	56645	7	338	56739	7	338	56833	7	339
38415	10	387	38513	10	394	38612	10	404	38735	10	401	38830	10	398	56646	7	338	56740	7	338	56834	7	339
38416	10	387	38514	10	394	38613	10	404	38736	10	401	38831	10	399	56647	7	338	56741	7	338	56835	7	339
38417	10	387	38515	10	394	38614	10	404	38737	10	401	50932	3	86	56648	7	338	56742	7	338	56836	7	339
38418	10	387	38516	10	394	38615	10	404	38738	10	401	50933	3	86	56649	7	338	56743	7	338	56837	7	339
38419	10	387	38517	10	394	38622	10	383	38739	10	401	50934	3	85	56650	7	338	56744	7	338	56838	7	339
38420	10	387	38518	10	394	38623	10	383	38740	10	401	50935	3	85	56651	7	338	56745	7	338	56839	7	339
38421	10	387	38519	10	394	38624	10	383	38741	10	401	50997	3	85	56652	7	338	56746	7	338	56840	7	339
38422	10	388	38520	10	394	38625	10	383	38742	10	401	50998	3	85	56653	7	338	56747	7	338	56841	7	339
38423	10	388	38521	10	394	38626	10	383	38743	10	401	50999	3	85	56654	7	338	56748	7	338	56842	7	339
38424	10	388	38522	10	395	38627	10	383	38744	10	401	51054	5	265	56655	7	338	56749	7	338	56843	7	339
38425	10	388	38523	10	395	38628	10	383	38745	10	401	51055	5	264	56656	7	338	56750	7	338	56844	7	339
38426	10	388	38524	10	395	38630	10	386	38746	10	401	51056	5	264	56657	7	338	56751	7	338	56845	7	339
38427	10	388	38525	10	395	38631	10	386	38747	10	401	51478	10	407	56658	7	338	56752	7	338	56846	7	339
38428	10	388	38526	10	395	38632	10	386	38748	10	401	51558	10	406	56659	7	338	56753	7	338	56847	7	339
38429	10	388	38527	10	395	38633	10	386	38749	10	401	51559	10	406	56660	7	338	56754	7	338	56848	7	339
38430	10	388	38528	10	395	38634	10	386	38750	10	401	51560	10	411	56661	7	338	56755	7	338	56849	7	339
38431	10	388	38529	10	395	38635	10	386	38751	10	401	51561	10	409	56662	7	338	56756	7	338	56850	7	339
38432	10	388	38530	10	395	38636	10	386	38752	10	401	51562	10	411	56663	7	338	56757	7	339	56851	7	339
38433	10	389	38531	10	395	38637	10	386	38753	10	401	51563	10	408	56664	7	338	56758	7	339	56852	7	339
38434	10	389	38532	10	395	38638	10	386	38754	10	401	51564	10	410	56665	7	338	56759	7	339	56853	7	339
38435	10	389	38533	10	395	38640	10	386	38755	10	401	55459	2	75	56666	7	338	56760	7	339	56854	7	339
38436	10	389	38534	10	395	38641	10	386	38756	10	401	55460	2	75	56667	7	338	56761	7	339	56855	7	339
38437	10	389	38535	10	395	38642	10	386	38757	10	401	55461	2	75	56668	7	338	56762	7	339	56856	7	339
38438	10	389	38536	10	395	38643	10	386	38758	10	401	55463	2	75	56669	7	338	56763	7	339	56857	7	339
38439	10	389	38537	10	395	38644	10	386	38759	10	401	55464	2	75	56670	7	338	56764	7	339	56858	7	339
38440	10	389	38538	10	395	38645	10	386	38760	10	401	55465	2	75	56671	7	338	56765	7	339	56859	7	339
38443	10	390	38539	10	395	38646	10	386	38761	10	401	56572	7	337	56672	7	338	56766	7	339	56860	7	339
38444	10	390	38540	10	395	38647	10	386	38762	10	401	56573	7	337	56673	7	338	56767	7	339	56861	7	339
38445	10	390	38541	10	395	38648	10	386	38763	10	401	56574	7	338	56674	7	338	56768	7	339	56862	7	339
38446	10	390	38542	10	396	38649	10	386	38764	10	401	56575	7	340	56675	7	338	56769	7	339	56863	7	339
38447	10	390	38543	10	396	38671	10	399	38765	10	401	56578	7	337	56676	7	338	56770	7	339	56864	7	339
38448	10	390	38544	10	396	38672	10	399	38766	10	402	56579	7	337	56677	7	338	56771	7	339	56865	7	339
38449	10	390	38545	10	396	38673	10	399	38767	10	402	56580	7	337	56678	7	338	56772	7	339	56866	7	339
38450	10	390	38546	10	396	38674	10	399	38768	10	402	56581	7	337	56679	7	338	56773	7	339	56867	7	339
38451	10	390	38547	10	396	38675	10	399	38769	10	402	56582	7	337	56680	7	338	56774	7	339	56868	7	339
38452	10	390	38548	10	396	38676	10	399	38770	10	402	56583	7	337	56681	7	338	56775	7	339	56869	7	339
38453	10	390	38549	10	396	38677	10	399	38771	10	402	56586	7	337	56682	7	338	56776	7	339	56870	7	339
38454	10	390	38550	10	396	38678	10	399	38772	10	402	56587	7	337	56683	7	338	56777	7	339	56871	7	339
38455	10	390	38551	10	396	38679	10	399	38773	10	402	56588	7	337	56684	7	338	56778	7	339	56872	7	339
38456	10	390	38552	10	396	38680	10	399	38774	10	402	56589	7	337	56685	7	338	56779	7	339	56873	7	339
38457	10	390	38553	10	396	38681	10	399	38775	10	402	56590	7	337	56686	7	338	56780	7	339	56874	7	339
38458	10	391	38554	10	397	38682	10	399	38776	10	402	56591	7	337	56687	7	338	56781	7	339	56875	7	339
38459	10	391	38555	10	397	38683	10	399	38777	10	402	56594	7	338	56688	7	338	56782	7	339	56876	7	339
38460	10	391	38556	10	397	38684	10	399	38778	10	402	56595	7	338	56689	7	338	56783	7	339	56877	7	339
38461	10	391	38557	10	397	38685	10	399	38779	10	402	56596	7	338	56690	7	338	56784	7	339	56878	7	339
38462	10	391	38558	10	397	38686	10	399	38780	10	402	56597	7	338	56691	7	338	56785	7	339	56879	7	339
38463	10	391	38559	10	397	38687	10	399	38781	10	402	56598	7	338	56692	7	338	56786	7	339	56880	7	339
38464	10	391	38560	10	397	38688	10	399	38782	10	402	56599	7	338	56693	7	338	56787	7	339	56881	7	339
38465	10	391	38561	10	397	38689	10	399	38783	10	402	56600	7	338	56694	7	338	56788	7	339	56882	7	339
38466	10	391	38562	10	397	38690	10	400	38784	10	402	56601	7										

COD.	CAP.	PAG.	COD.	CAP.	PAG.	COD.	CAP.	PAG.	COD.	CAP.	PAG.	COD.	CAP.	PAG.	COD.	CAP.	PAG.	COD.	CAP.	PAG.	COD.	CAP.	PAG.
64734	2	74	70149	5	155	70242	5	159	70336	5	197	70430	5	245	70524	5	261	70618	5	156	70711	5	157
64735	2	74	70150	5	155	70243	5	159	70337	5	197	70431	5	245	70525	5	262	70619	5	156	70712	5	157
64736	2	74	70151	5	155	70244	5	159	70338	5	197	70432	5	245	70526	5	262	70620	5	156	70713	5	157
64737	2	74	70152	5	155	70245	5	159	70339	5	197	70433	5	245	70527	5	262	70621	5	156	70714	5	157
64740	2	75	70153	5	155	70246	5	159	70340	5	197	70434	5	245	70528	5	241	70622	5	156	70715	5	157
64741	2	75	70154	5	155	70247	5	159	70341	5	197	70435	5	245	70529	5	241	70623	5	156	70716	5	157
64742	2	75	70155	5	155	70248	5	167	70342	5	197	70436	5	245	70530	5	150	70624	5	156	70717	5	157
64743	2	75	70156	5	155	70249	5	167	70343	5	197	70437	5	245	70531	5	150	70625	5	156	70718	5	157
64744	2	75	70157	5	155	70250	5	167	70344	5	197	70438	5	245	70532	5	150	70626	5	156	70719	5	157
64745	2	75	70158	5	155	70251	5	167	70345	5	202	70439	5	245	70533	5	150	70627	5	156	70720	5	157
64746	2	75	70159	5	155	70252	5	167	70346	5	202	70440	5	245	70534	5	150	70628	5	156	70721	5	157
64747	2	76	70160	5	155	70253	5	167	70347	5	202	70441	5	245	70535	5	150	70629	5	156	70722	5	157
64748	2	76	70161	5	155	70254	5	167	70348	5	202	70442	5	245	70536	5	150	70630	5	156	70723	5	157
64749	2	76	70162	5	155	70255	5	167	70349	5	202	70443	5	245	70537	5	150	70631	5	156	70724	5	157
64753	2	76	70163	5	155	70256	5	167	70350	5	202	70444	5	245	70538	5	150	70632	5	156	70725	5	158
64754	2	76	70164	5	155	70257	5	167	70351	5	202	70445	5	245	70539	5	150	70633	5	156	70726	5	158
64756	2	76	70165	5	155	70258	5	167	70352	5	202	70446	5	245	70540	5	152	70634	5	156	70727	5	158
64757	2	76	70166	5	155	70259	5	181	70353	5	207	70447	5	244	70541	5	152	70635	5	156	70728	5	158
64758	2	76	70167	5	155	70260	5	181	70354	5	207	70448	5	244	70542	5	153	70636	5	156	70729	5	158
64762	2	76	70168	5	155	70261	5	181	70355	5	207	70449	5	244	70543	5	153	70637	5	156	70730	5	158
64763	2	76	70169	5	155	70262	5	181	70356	5	207	70450	5	244	70544	5	151	70638	5	156	70731	5	158
64764	2	76	70170	5	157	70263	5	181	70357	5	207	70451	5	244	70545	5	241	70639	5	156	70732	5	158
64765	2	76	70171	5	157	70264	5	181	70358	5	207	70452	5	246	70546	5	241	70640	5	156	70733	5	158
64767	2	75	70172	5	157	70265	5	181	70359	5	207	70453	5	246	70547	5	154	70641	5	156	70734	5	158
66062	3	83	70172	10	384	70266	5	181	70360	5	207	70454	5	246	70548	5	154	70642	5	156	70735	5	158
66063	3	83	70173	5	157	70267	5	181	70361	5	207	70455	5	246	70549	5	155	70643	5	156	70736	5	158
66064	3	83	70174	5	157	70268	5	181	70362	5	207	70456	5	246	70550	5	155	70644	5	156	70737	5	158
66068	3	83	70175	5	157	70269	5	181	70363	5	207	70457	5	246	70551	5	155	70645	5	156	70738	5	158
66078	3	83	70176	5	157	70270	5	181	70364	5	207	70458	5	246	70552	5	155	70646	5	156	70739	5	158
66105	3	85	70177	5	157	70271	5	181	70365	5	207	70459	5	246	70553	5	155	70647	5	156	70740	5	158
66108	3	84	70178	5	157	70272	5	181	70366	5	207	70460	5	246	70554	5	155	70648	5	156	70741	5	158
66109	3	84	70179	5	157	70273	5	181	70367	5	207	70461	5	246	70555	5	155	70649	5	156	70742	5	158
66112	3	83	70180	5	157	70274	5	181	70368	5	206	70462	5	246	70556	5	155	70650	5	156	70743	5	158
66113	3	84	70181	5	157	70275	5	181	70369	5	201	70463	5	246	70557	5	155	70651	5	156	70744	5	158
66116	3	84	70182	5	157	70276	5	181	70370	5	211	70464	5	246	70558	5	155	70652	5	156	70745	5	158
66117	3	84	70183	5	157	70277	5	181	70371	5	206	70465	5	246	70559	5	155	70653	5	156	70746	5	158
67243	1	24	70184	5	157	70278	5	181	70372	5	201	70466	5	246	70560	5	155	70654	5	156	70747	5	158
68898	2	77	70185	5	157	70279	5	181	70373	5	206	70467	5	246	70561	5	155	70655	5	156	70748	5	158
68899	2	77	70186	5	157	70280	5	170	70374	5	211	70468	5	246	70562	5	155	70656	5	156	70749	5	158
69342	1	26	70187	5	157	70281	5	170	70375	5	200	70469	5	246	70563	5	155	70657	5	156	70750	5	158
69342	10	384	70188	5	157	70282	5	170	70376	5	205	70470	5	246	70564	5	155	70658	5	156	70751	5	158
69342	10	384	70189	5	157	70283	5	170	70377	5	246	70471	5	250	70565	5	155	70659	5	156	70752	5	158
69728	5	264	70190	5	157	70284	5	170	70378	5	200	70472	5	250	70566	5	155	70660	5	156	70753	5	158
69729	5	264	70191	5	157	70285	5	170	70379	5	200	70473	5	250	70567	5	155	70661	5	156	70754	5	158
69730	5	264	70192	5	157	70286	5	170	70380	5	206	70474	5	250	70568	5	155	70662	5	156	70755	5	158
70100	5	150	70193	5	157	70287	5	170	70381	5	206	70475	5	250	70569	5	155	70663	5	156	70756	5	158
70101	5	150	70194	5	157	70288	5	170	70382	5	211	70476	5	251	70570	5	155	70664	5	156	70757	5	158
70102	5	150	70195	5	157	70289	5	170	70383	5	201	70477	5	251	70571	5	155	70665	5	156	70758	5	158
70103	5	150	70196	5	157	70290	5	170	70384	5	201	70478	5	251	70572	5	155	70666	5	156	70759	5	158
70104	5	150	70197	5	157	70291	5	170	70385	5	201	70479	5	255	70573	5	155	70667	5	156	70760	5	158
70105	5	150	70198	5	157	70292	5	170	70386	5	206	70480	5	255	70574	5	155	70668	5	156	70761	5	158
70106	5	150	70199	5	157	70293	5	170	70387	5	206	70481	5	255	70575	5	155	70669	5	156	70762	5	158
70107	5	150	70200	5	157	70294	5	170	70388	5	206	70482	5	236	70576	5	155	70670	5	156	70763	5	158
70108	5	150	70201	5	157	70295	5	170	70389	5	211	70483	5	236	70577	5	155	70671	5	156	70764	5	158
70109	5	150	70202	5	157	70296	5	170	70390	5	211	70484	5	204	70578	5	155	70672	5	156	70765	5	158
70110	5	152	70203	5	157	70297	5	172	70391	5	189	70485	5	204	70579	5	155	70673	5	156	70766	5	158
70111	5	152	70204	5	157	70298	5	172	70392	5	189	70486	5	236	70580	5	155	70674	5	156	70767	5	158
70112	5	153	70205	5	157	70299	5	172	70393	5	189	70487	5	236	70581	5	155	70675	5	156	70768	5	158
70113	5	153	70206	5	157	70300	5	172	70394	5	189	70488	5	256	70582	5	155	70676	5	156	70769	5	158
70114	5	151	70207	5	157	70301	5	172	70395	5	189	70489	5	256	70583	5	155	70677	5	156	70770	5	158
70115	5	154	70208	5	157	70302	5	172	70396	5	189	70490	5	256	70584	5	155	70678	5	156	70771	5	158
70116	5	154	70209	5	157	70303	5	172	70397	5	189	70491	5	256	70585	5	155	70679	5	156	70772	5	158
70117</																							





COD.	CAP.	PAG.	COD.	CAP.	PAG.	COD.	CAP.	PAG.	COD.	CAP.	PAG.	COD.	CAP.	PAG.	COD.	CAP.	PAG.	COD.	CAP.	PAG.	COD.	CAP.	PAG.
71571	5	246	71674	9	363	71769	5	260	71879	9	369	71974	9	362	72068	9	365	72168	5	250	72272	5	237
71572	5	246	71675	9	363	71770	5	260	71880	9	369	71975	9	362	72069	9	365	72169	5	234	72273	5	237
71573	5	247	71676	9	363	71771	5	261	71881	9	369	71976	9	362	72070	9	365	72170	5	234	72274	5	237
71574	5	247	71677	9	363	71772	5	261	71882	9	369	71977	9	362	72071	9	370	72171	5	190	72275	5	237
71575	5	247	71678	9	363	71773	5	261	71883	9	369	71978	9	363	72072	9	370	72172	5	190	72276	5	237
71576	5	247	71679	9	363	71774	5	261	71884	9	369	71979	9	363	72073	9	370	72173	5	190	72277	5	237
71577	5	247	71680	9	363	71775	5	261	71885	9	369	71980	9	363	72074	9	370	72174	5	190	72278	5	237
71578	5	247	71681	9	363	71776	5	261	71886	9	369	71981	9	363	72075	9	370	72175	5	190	72279	5	237
71579	5	247	71682	9	363	71777	5	261	71887	9	369	71982	9	363	72077	9	372	72176	5	190	72280	5	237
71580	5	247	71683	9	363	71778	5	261	71888	9	369	71983	9	363	72078	9	372	72177	5	188	72281	5	237
71581	5	237	71684	9	363	71779	5	261	71889	9	372	71984	9	363	72079	9	372	72178	5	188	72282	5	237
71582	5	237	71685	9	363	71780	5	262	71890	9	362	71985	9	363	72080	9	372	72179	5	188	72283	5	237
71583	5	237	71686	9	364	71781	5	262	71891	9	362	71986	9	363	72081	9	372	72180	5	188	72284	5	237
71584	5	237	71687	9	364	71782	5	262	71892	9	362	71987	9	363	72082	9	361	72181	5	188	72285	5	237
71585	5	237	71688	9	364	71783	9	366	71893	9	362	71988	9	363	72083	9	372	72182	5	188	72286	5	237
71586	5	237	71689	9	364	71784	9	368	71894	9	362	71989	9	363	72084	5	172	72183	5	188	72287	5	237
71587	5	237	71691	9	367	71785	9	369	71895	9	362	71990	9	363	72085	5	172	72184	5	188	72288	5	237
71588	5	237	71692	9	367	71786	5	157	71896	9	362	71991	9	363	72086	5	172	72185	5	188	72289	5	237
71589	5	237	71693	9	367	71787	5	157	71897	9	362	71992	9	363	72087	5	172	72186	5	188	72290	5	237
71590	5	237	71694	9	367	71789	5	173	71898	9	362	71993	9	363	72088	5	172	72187	5	188	72291	5	237
71591	5	237	71695	9	367	71791	5	173	71899	9	362	71994	9	363	72089	5	172	72188	5	188	72292	5	237
71592	5	237	71696	9	367	71793	5	173	71900	9	362	71995	9	363	72090	5	172	72189	5	188	72293	5	237
71593	5	237	71697	9	367	71794	5	173	71901	9	362	71996	9	363	72091	5	172	72190	5	188	72294	5	237
71594	5	237	71698	9	367	71797	5	173	71902	9	362	71997	9	363	72092	5	172	72191	5	236	72295	5	237
71595	5	237	71699	9	367	71798	5	173	71903	9	362	71998	9	364	72093	5	172	72192	5	236	72296	5	237
71596	5	237	71700	9	367	71799	5	173	71904	9	362	71999	9	364	72094	5	150	72193	9	371	72297	5	237
71597	5	238	71701	9	366	71800	5	173	71905	9	362	72000	9	364	72095	5	150	72194	9	371	72298	5	237
71598	5	238	71702	9	366	71801	5	173	71906	5	172	72001	9	364	72096	5	186	72195	9	371	72299	5	237
71599	5	237	71703	9	366	71807	5	181	71908	5	202	72002	9	364	72097	5	186	72196	9	371	72300	5	152
71600	5	237	71704	9	366	71808	5	181	71909	5	191	72003	9	364	72098	5	260	72197	9	371	72301	5	173
71601	5	238	71705	9	366	71809	5	181	71910	5	191	72004	9	364	72099	5	260	72198	9	371	72302	5	152
71602	5	238	71706	9	366	71810	5	181	71911	5	191	72005	9	364	72100	5	171	72199	9	371	72303	5	173
71603	5	243	71707	9	366	71811	5	181	71912	5	191	72006	9	364	72101	5	171	72200	9	371	72304	5	237
71605	5	243	71708	9	366	71812	5	181	71913	5	191	72007	9	364	72102	5	171	72201	9	371	72307	5	237
71607	5	243	71709	9	366	71813	5	181	71914	5	191	72008	9	364	72103	5	171	72202	9	371	72308	5	237
71608	5	243	71710	9	366	71814	5	181	71915	5	191	72009	9	364	72104	5	171	72203	9	371	72309	5	237
71611	5	242	71711	9	366	71815	5	181	71916	5	191	72010	9	364	72105	5	171	72204	9	371	72314	5	221
71612	5	242	71712	9	364	71816	5	181	71917	5	191	72011	9	367	72106	5	171	72205	9	371	72315	5	221
71613	5	242	71713	9	364	71817	5	181	71918	5	191	72012	9	367	72107	5	171	72206	9	371	72316	5	221
71614	5	242	71714	9	364	71818	5	181	71919	5	191	72013	9	367	72108	5	171	72207	9	371	72317	5	221
71615	5	240	71715	9	364	71821	5	155	71920	5	191	72014	9	367	72109	5	171	72208	9	371	72318	5	221
71616	5	240	71716	9	364	71822	5	235	71921	5	191	72015	9	367	72110	5	171	72209	9	371	72319	5	221
71617	5	240	71717	9	365	71823	5	235	71922	5	191	72016	9	367	72111	5	171	72210	5	172	72320	5	221
71618	5	240	71718	9	365	71824	9	362	71923	5	191	72017	9	367	72112	5	171	72211	5	258	72321	5	221
71619	5	240	71719	9	365	71825	9	362	71924	5	191	72018	9	367	72113	5	171	72212	5	172	72322	5	221
71620	5	240	71720	9	365	71826	9	362	71925	5	191	72019	9	367	72114	5	171	72213	5	258	72323	5	221
71621	5	250	71721	9	365	71827	9	362	71926	5	191	72020	9	367	72115	5	171	72214	5	249	72324	5	221
71622	5	250	71722	9	370	71828	9	363	71927	5	191	72021	9	367	72116	5	173	72215	5	249	72325	5	221
71623	5	250	71723	9	370	71829	9	363	71928	5	191	72022	9	367	72117	5	173	72216	5	242	72326	5	221
71624	5	250	71724	9	370	71830	9	363	71929	5	191	72023	9	367	72118	5	173	72217	5	242	72327	5	221
71625	5	250	71725	9	370	71831	9	363	71930	5	191	72024	9	367	72119	5	173	72218	5	242	72328	5	221
71626	5	251	71726	9	371	71832	9	363	71931	5	191	72025	9	367	72120	5	173	72219	4	138	72329	5	221
71627	5	251	71727	9	371	71833	9	363	71932	5	191	72026	9	368	72121	5	173	72220	4	138	72330	5	225
71628	5	251	71728	9	371	71834	5	172	71933	5	191	72027	9	368	72122	5	173	72221	4	138	72331	5	225
71632	5	255	71729	9	371	71835	5	172	71934	5	191	72028	9	368	72123	5	173	72222	4	138	72332	5	225
71634	5	255	71730	9	371	71838	9	365	71935	5	191	72029	9	368	72124	5	173	72223	5	172	72333	5	225
71636	5	236	71731	9	361	71839	9	365	71936	5	191	72030	9	368	72125	5	173	72224	5	172	72334	5	225
71637	5	236	71732	5	167	71840	9	365	71937	5	191	72031	9	368	72126	5	173	72225	5	172	72335	5	225
71638	5	254	71733	5	167	71841	9	365	71938	5	191	72032	9	368	72127	5	173	72226	5	172	72336	5	225
71639	5	254	71734	5	167	71842	9	365	71939	5	191	72033	9	368	72128	5	159	72227	5	243	72337	5	225
71640	5	254	71735	5	167	71843	9	365	71940	5	191	72034	9	368	72129	5	159	72228	5	189	72338	5	225
71641	5	254	71736	5	167	71844	9	365	71941	5	191	72035	9	368	72130	5	159	72229	5	189			

COD.	CAP.	PAG.	COD.	CAP.	PAG.	COD.	CAP.	PAG.	COD.	CAP.	PAG.	COD.	CAP.	PAG.	COD.	CAP.	PAG.	COD.	CAP.	PAG.	COD.	CAP.	PAG.
72372	5	225	72486	5	252	72585	5	247	72693	5	172	72792	5	256	72910	5	237	73054	1	26	73173	1	29
72373	5	225	72487	5	252	72586	5	247	72694	5	172	72793	5	256	72911	5	181	73055	1	26	73174	1	29
72374	5	225	72488	5	252	72587	5	247	72695	5	172	72794	5	263	72912	5	159	73060	1	26	73175	1	29
72375	5	225	72489	5	252	72588	5	247	72697	5	172	72795	5	263	72913	5	159	73061	1	26	73176	1	29
72376	5	225	72490	5	253	72589	5	248	72698	5	172	72796	5	263	72914	5	183	73062	1	26	73177	1	29
72377	5	225	72491	9	368	72590	5	248	72699	5	172	72797	5	263	72915	5	184	73062	10	384	73178	1	29
72396	5	206	72492	9	368	72591	5	248	72700	5	157	72798	5	263	72916	5	183	73063	1	26	73179	1	29
72397	5	206	72493	9	370	72592	5	248	72701	5	157	72799	5	263	72917	5	184	73064	1	26	73180	1	29
72398	5	211	72494	9	367	72593	5	248	72702	5	172	72822	5	159	72919	5	155	73065	1	26	73181	1	29
72399	5	211	72495	9	367	72594	5	248	72703	5	172	72823	5	159	72921	5	155	73066	1	26	73182	1	29
72400	5	201	72496	9	368	72595	5	248	72704	5	172	72825	5	272	72922	5	155	73067	1	26	73183	1	29
72401	5	201	72497	9	366	72596	5	248	72705	5	172	72826	5	272	72923	5	155	73068	1	26	73184	1	29
72402	5	201	72498	9	368	72597	5	248	72706	5	172	72827	5	272	72924	5	155	73069	1	26	73185	1	29
72403	5	201	72499	9	370	72598	5	248	72707	5	158	72828	5	272	72925	5	155	73070	1	26	73186	1	29
72404	5	201	72500	9	368	72599	5	248	72708	5	172	72829	5	272	72926	5	155	73071	1	26	73187	1	29
72405	5	201	72501	9	370	72600	5	248	72709	5	172	72830	5	272	72927	5	155	73072	1	26	73188	1	29
72406	5	206	72502	9	368	72601	5	247	72710	5	172	72831	5	272	72928	5	189	73073	1	26	73189	1	28
72407	5	206	72503	9	365	72602	5	247	72711	5	172	72832	5	272	72929	5	189	73074	1	26	73190	1	28
72408	5	211	72504	9	365	72603	5	247	72712	5	172	72833	5	272	72930	5	189	73075	1	26	73191	1	28
72409	5	211	72505	9	365	72604	5	247	72713	5	172	72835	5	272	72931	5	189	73076	1	26	73192	1	28
72410	5	201	72506	9	365	72605	5	180	72714	5	172	72836	5	272	72932	5	189	73077	1	26	73198	1	28
72411	5	201	72507	9	365	72606	5	180	72716	5	172	72837	5	272	72933	5	189	73078	1	26	73199	1	28
72412	5	206	72508	9	365	72607	5	180	72717	5	172	72838	5	272	72934	5	189	73079	1	26	73200	1	28
72413	5	206	72509	9	372	72609	5	172	72719	5	172	72839	5	272	72935	5	189	73080	1	26	73201	1	28
72414	5	211	72510	5	151	72610	5	172	72721	5	172	72840	5	272	72936	5	158	73081	1	26	73202	1	28
72415	5	211	72511	5	151	72611	5	172	72723	5	169	72841	5	272	72937	5	158	73082	1	26	73203	1	29
72416	5	201	72512	5	151	72612	5	180	72724	5	169	72842	5	272	72939	5	181	73083	1	26	73204	1	29
72417	5	201	72513	5	151	72613	5	172	72725	5	169	72843	5	272	72940	5	181	73086	1	26	73205	1	29
72418	5	233	72514	5	151	72615	5	172	72726	5	169	72844	5	273	72941	5	181	73088	1	21	73206	1	29
72419	5	233	72515	5	151	72616	5	172	72727	5	169	72845	5	273	72942	5	181	73090	1	27	73207	1	29
72420	5	233	72516	5	151	72617	5	172	72728	5	169	72846	5	273	72943	5	181	73091	1	27	73208	1	29
72421	5	233	72517	5	151	72618	5	172	72729	5	169	72847	5	273	72944	5	181	73092	1	27	73209	1	29
72422	5	233	72518	5	151	72619	5	172	72730	5	169	72848	5	273	72945	5	181	73093	1	27	73210	1	29
72423	5	233	72519	5	151	72620	5	172	72731	5	169	72849	5	273	72946	5	181	73094	1	27	73211	1	29
72424	5	233	72520	5	151	72621	5	172	72732	5	169	72850	5	273	72947	5	181	73095	1	27	73212	1	29
72425	5	233	72521	5	151	72623	5	172	72733	5	169	72851	5	272	72948	5	181	73096	1	27	73213	1	29
72426	5	233	72526	5	255	72624	5	158	72734	5	169	72852	5	272	72949	5	181	73097	1	27	73214	1	29
72427	5	233	72527	9	372	72625	5	172	72735	5	169	72853	5	272	72950	5	181	73098	1	27	73215	1	29
72428	5	233	72528	9	371	72626	5	172	72736	5	169	72854	5	272	72951	5	172	73099	1	27	73216	1	29
72429	5	233	72529	9	371	72627	5	172	72737	5	169	72855	5	272	72953	5	202	73100	1	27	73217	1	29
72430	5	233	72530	9	371	72628	5	172	72738	5	169	72856	5	271	72954	5	173	73101	1	27	73218	1	29
72431	5	233	72531	9	371	72629	5	210	72739	5	255	72857	5	271	72955	5	181	73102	1	27	73219	1	29
72432	5	233	72532	9	361	72630	5	210	72740	5	259	72858	5	271	72956	5	159	73103	1	27	73220	1	29
72433	5	233	72533	9	361	72631	5	172	72741	5	259	72859	5	271	72957	5	159	73104	1	27	73221	1	29
72434	5	233	72534	9	372	72632	5	158	72742	5	259	72860	5	271	72974	5	258	73105	1	27	73222	1	29
72435	5	233	72535	9	372	72633	5	172	72743	5	259	72861	5	271	72975	5	258	73106	1	27	73223	1	29
72436	5	233	72536	9	372	72634	5	172	72744	5	259	72862	5	271	72976	5	236	73107	1	27	73224	1	29
72437	5	233	72537	9	371	72635	5	172	72745	5	259	72863	5	271	72977	5	236	73108	1	27	73225	1	29
72438	5	233	72538	9	372	72636	5	172	72746	5	259	72864	5	271	72978	5	236	73109	1	27	73226	1	29
72439	5	233	72540	9	366	72638	5	172	72747	5	259	72865	5	271	72979	5	236	73110	1	27	73228	1	32
72440	5	233	72541	5	178	72640	5	172	72748	5	259	72866	5	271	72980	5	236	73111	1	27	73229	1	32
72441	5	233	72542	5	178	72642	5	172	72749	5	259	72867	5	270	72981	5	236	73112	1	27	73230	1	32
72442	5	233	72543	5	178	72643	5	172	72750	5	259	72868	5	270	72982	5	236	73113	1	27	73231	1	32
72443	5	233	72544	5	178	72644	5	172	72751	5	259	72869	5	270	72983	5	236	73114	1	27	73232	1	32
72444	5	233	72545	5	178	72645	5	172	72752	5	259	72870	5	270	72992	5	174	73115	1	27	73233	1	32
72445	5	233	72546	5	178	72646	5	172	72753	5	259	72871	5	270	72993	5	174	73116	1	27	73234	1	32
72446	5	233	72547	5	178	72647	5	172	72754	5	259	72872	5	270	73001	1	22	73117	1	27	73235	1	32
72447	5	233	72548	5	178	72648	5	172	72755	5	259	72873	5	270	73004	1	22	73118	1	27	73236	1	32
72448	5	233	72549	5	178	72649	5	172	72756	5	259	72874	5	270	73005	1	22	73119	1	27	73237	1	32
72449	5	233	72550	5	178	72650	5	172	72757	5	259	72875	5	270	73006	5	155	73120	1	28	73238	1	32
72450	5	233	72551	5	178	72651	5	172	72758	5	263	72876	5	270	73007	5	155	73121	1	28	73239	1	32
72451	5	233	72552	5	178	72652	5	172	72759	5	263	72877	5	270	73008	1	23	73122	1	28	73240	1	32
72452	5	234	72553	5	178	72653	5	172	72760	5	263												





COD.	CAP.	PAG.	COD.	CAP.	PAG.	COD.	CAP.	PAG.	COD.	CAP.	PAG.	COD.	CAP.	PAG.	COD.	CAP.	PAG.	COD.	CAP.	PAG.	COD.	CAP.	PAG.
75058	1	33	75160	1	38	75255	5	155	75367	5	160	75468	5	174	75567	5	191	75661	5	194	75755	5	203
75059	1	33	75161	1	38	75256	5	155	75368	5	160	75471	5	176	75568	5	191	75662	5	194	75756	5	203
75060	1	33	75162	1	38	75257	5	155	75369	5	160	75472	5	176	75569	5	191	75663	5	194	75757	5	203
75061	1	33	75163	1	38	75258	5	155	75370	5	160	75473	5	176	75570	5	191	75664	5	194	75758	5	203
75062	1	33	75164	1	38	75259	5	155	75371	5	160	75474	5	176	75571	5	191	75665	5	194	75759	5	203
75063	1	53	75165	1	38	75260	5	155	75372	5	160	75475	5	176	75572	5	191	75666	5	194	75760	5	203
75064	1	53	75166	1	38	75261	5	155	75373	5	160	75476	5	176	75573	5	191	75667	5	194	75761	5	203
75065	1	53	75167	1	38	75262	5	155	75374	5	160	75477	5	201	75574	5	191	75668	5	194	75762	5	203
75066	1	53	75168	1	38	75263	5	155	75375	5	160	75478	5	201	75575	5	191	75669	5	194	75763	5	203
75067	1	53	75169	1	38	75264	5	155	75376	5	160	75479	5	183	75576	5	191	75670	5	194	75764	5	203
75068	1	53	75170	1	38	75265	5	155	75377	5	160	75480	5	183	75577	5	191	75671	5	194	75765	5	203
75069	1	53	75171	1	38	75266	5	155	75378	5	160	75481	5	183	75578	5	191	75672	5	194	75766	5	203
75070	1	33	75172	1	58	75267	5	190	75379	5	160	75482	5	183	75579	5	191	75673	5	194	75767	5	203
75071	1	33	75173	1	58	75268	5	237	75380	5	160	75483	5	183	75580	5	191	75674	5	194	75768	5	203
75072	1	33	75174	1	58	75269	5	237	75381	5	160	75484	5	183	75581	5	191	75675	5	194	75769	5	203
75073	1	33	75175	1	58	75274	5	190	75382	5	160	75485	5	183	75582	5	191	75676	5	194	75770	5	203
75074	1	33	75176	1	58	75275	5	156	75383	5	160	75486	5	183	75583	5	191	75677	5	194	75771	5	203
75075	1	33	75177	1	58	75276	5	156	75384	5	160	75487	5	206	75584	5	191	75678	5	194	75772	5	207
75076	1	33	75178	1	58	75277	5	156	75385	5	181	75488	5	206	75585	5	191	75679	5	194	75773	5	207
75077	1	33	75179	1	58	75278	5	156	75386	5	181	75489	5	183	75586	5	191	75680	5	194	75774	5	207
75078	1	33	75180	1	44	75281	5	156	75387	5	181	75490	5	183	75587	5	191	75681	5	194	75775	5	207
75079	1	33	75181	1	44	75282	5	156	75388	5	181	75491	5	183	75588	5	191	75682	5	194	75776	5	207
75080	1	33	75182	1	44	75283	5	156	75389	5	181	75492	5	183	75589	5	191	75683	5	194	75777	5	207
75081	1	53	75183	1	44	75284	5	156	75390	5	181	75493	5	183	75590	5	191	75684	5	194	75778	5	207
75083	1	58	75184	1	44	75285	5	156	75391	5	181	75494	5	183	75591	5	191	75685	5	194	75779	5	207
75084	1	58	75185	1	44	75286	5	156	75392	5	181	75495	5	183	75592	5	194	75686	5	194	75780	5	207
75085	1	33	75186	1	44	75287	5	156	75393	5	181	75496	5	183	75593	5	194	75687	5	194	75781	5	207
75086	1	33	75187	1	44	75288	5	156	75394	5	181	75497	5	183	75594	5	194	75688	5	194	75782	5	207
75087	1	33	75188	1	44	75289	5	156	75395	5	181	75498	5	183	75595	5	194	75689	5	194	75783	5	207
75088	1	33	75189	1	44	75290	5	156	75396	5	181	75499	5	183	75596	5	194	75690	5	194	75784	5	207
75089	1	33	75191	1	44	75291	5	156	75397	5	173	75500	5	183	75597	5	194	75691	5	194	75785	5	207
75090	1	33	75192	1	44	75292	5	156	75398	5	173	75501	5	183	75598	5	194	75692	5	194	75786	5	207
75091	1	33	75193	1	44	75293	5	156	75399	5	173	75502	5	183	75599	5	194	75693	5	194	75787	5	207
75092	1	33	75194	1	44	75294	5	156	75400	5	173	75503	5	183	75600	5	194	75694	5	194	75788	5	207
75093	1	33	75195	1	44	75295	5	156	75401	5	173	75504	5	183	75601	5	194	75695	5	194	75789	5	207
75094	1	33	75196	1	44	75296	5	156	75402	5	173	75505	5	183	75602	5	194	75696	5	194	75790	5	207
75097	1	58	75197	1	44	75297	5	156	75403	5	173	75506	5	183	75603	5	194	75697	5	194	75791	5	207
75098	5	153	75198	1	44	75298	5	156	75404	5	173	75507	5	183	75604	5	194	75698	5	194	75792	5	207
75099	5	153	75199	1	44	75300	5	197	75405	5	173	75508	5	183	75605	5	194	75699	5	194	75793	5	207
75100	1	33	75200	1	44	75301	5	197	75406	5	173	75509	5	183	75606	5	194	75700	5	196	75794	5	207
75101	1	33	75201	1	59	75302	5	198	75407	5	173	75510	5	183	75607	5	194	75701	5	196	75795	5	207
75102	1	33	75202	1	59	75303	5	198	75408	5	173	75511	5	183	75608	5	194	75702	5	196	75796	5	207
75103	1	33	75203	1	59	75305	5	158	75409	5	173	75512	5	183	75609	5	194	75703	5	196	75797	5	207
75104	1	33	75204	1	34	75306	5	158	75410	5	173	75513	5	183	75610	5	194	75704	5	196	75798	5	208
75105	1	33	75205	1	44	75307	5	158	75411	5	173	75514	5	183	75611	5	194	75705	5	196	75799	5	208
75106	1	33	75206	1	44	75308	5	158	75412	5	173	75515	5	184	75612	5	194	75706	5	196	75800	5	208
75107	1	33	75207	1	44	75309	5	158	75413	5	173	75516	5	184	75613	5	194	75707	5	196	75801	5	208
75108	1	33	75208	1	44	75310	5	158	75414	5	173	75517	5	184	75614	5	194	75708	5	196	75802	5	208
75109	1	33	75209	1	44	75311	5	158	75415	5	173	75518	5	184	75615	5	194	75709	5	196	75803	5	208
75110	1	33	75210	1	44	75312	5	158	75416	5	173	75519	5	184	75616	5	194	75710	5	196	75804	5	208
75111	5	153	75211	5	262	75315	5	153	75417	5	173	75520	5	184	75617	5	194	75711	5	196	75805	5	208
75112	5	153	75212	5	262	75316	5	153	75418	5	165	75521	5	184	75618	5	194	75712	5	196	75806	5	208
75113	5	153	75213	5	262	75318	5	159	75419	5	165	75522	5	184	75619	5	194	75713	5	196	75807	5	208
75114	5	153	75214	5	262	75319	5	159	75420	5	165	75523	5	184	75620	5	194	75714	5	196	75808	5	208
75115	1	38	75215	1	44	75320	5	159	75421	5	165	75524	5	184	75621	5	194	75715	5	196	75809	5	208
75116	1	38	75216	1	44	75321	5	159	75422	5	167	75525	5	184	75622	5	194	75716	5	196	75810	5	208
75117	1	38	75217	1	44	75322	5	159	75425	5	167	75526	5	184	75623	5	194	75717	5	196	75811	5	208
75118	1	38	75218	1	44	75323	5	159	75426	5	167	75527	5	184	75624	5	194	75718	5	193	75812	5	208
75119	1	38	75219	1	44	75324	5	159	75427	5	167	75528	5	184	75625	5	194	75719	5	193	75813	5	208
75120	1	38	75220	1	44	75325	5	159	75428	5	167	75529	5	184	75626	5	194	75720	5	201	75814	5	208
75121	1	38	75221	1	44	75326	5	159	75429	5	167	75530	5	184	75627	5	194	75721	5	201	75815	5	208
75122	1	38	75222	1	44	75327	5	159	75430	5	167	75531	5	184	75628	5	194	75722	5	196	75816	5	208
75123	1	38	75223	1	44	75328	5	159	75431	5													

COD.	CAP.	PAG.	COD.	CAP.	PAG.	COD.	CAP.	PAG.	COD.	CAP.	PAG.	COD.	CAP.	PAG.	COD.	CAP.	PAG.	COD.	CAP.	PAG.	COD.	CAP.	PAG.
75849	5	207	75943	5	225	76357	5	220	76464	5	158	76607	1	17	76707	5	254	76823	5	174	76941	1	62
75850	5	207	75944	5	225	76358	5	220	76465	5	239	76609	1	17	76709	5	254	76824	5	174	76942	1	64
75851	5	207	75945	5	225	76359	5	220	76466	5	239	76611	1	18	76711	5	232	76825	5	174	76943	1	64
75852	5	207	75946	5	225	76360	5	220	76467	5	239	76612	1	18	76712	5	232	76826	5	174	76944	1	64
75853	5	207	75947	5	225	76361	5	220	76468	5	239	76613	1	18	76713	5	232	76827	5	174	76948	1	65
75854	5	208	75966	5	195	76362	5	220	76469	5	239	76614	1	18	76714	5	232	76828	5	174	76949	1	65
75855	5	208	75967	5	195	76363	5	220	76470	5	239	76615	1	18	76715	5	232	76829	5	174	76950	1	65
75856	5	208	75968	5	221	76364	5	220	76471	5	239	76616	1	19	76716	5	232	76830	5	174	76951	1	64
75857	5	208	76021	5	175	76365	5	220	76472	5	239	76617	1	19	76718	5	175	76839	5	167	76952	1	64
75858	5	208	76022	5	175	76366	5	220	76474	5	150	76618	1	19	76719	5	175	76840	5	167	76953	1	64
75859	5	208	76083	1	65	76367	5	220	76475	5	150	76619	1	19	76720	5	175	76841	5	167	76954	1	64
75860	5	208	76084	5	165	76368	5	220	76480	5	237	76620	1	53	76721	5	175	76842	5	167	76955	1	64
75861	5	208	76085	5	165	76369	5	220	76481	5	237	76621	1	53	76722	5	175	76849	5	173	76956	1	64
75862	5	208	76088	5	175	76370	5	220	76482	5	237	76622	1	53	76723	5	175	76850	5	173	76957	1	65
75863	5	208	76089	5	175	76371	5	220	76483	5	237	76623	1	53	76724	5	175	76851	5	173	76958	1	65
75864	5	208	76090	5	155	76372	5	220	76484	5	237	76624	1	53	76725	5	175	76852	5	173	76959	1	65
75865	5	208	76091	5	155	76373	5	220	76485	5	237	76625	1	53	76726	5	175	76853	5	227	76961	1	63
75866	5	208	76092	5	155	76374	5	220	76486	5	237	76626	1	53	76727	5	175	76854	5	227	76962	1	63
75867	5	208	76093	5	155	76375	5	220	76487	5	237	76627	1	53	76728	5	175	76855	5	158	76963	1	65
75868	5	208	76094	5	155	76376	5	220	76488	5	237	76628	1	54	76729	5	175	76856	5	158	76964	1	65
75869	5	208	76095	5	155	76377	5	220	76489	5	237	76629	1	54	76730	1	58	76857	5	158	76965	1	65
75870	5	208	76096	5	155	76378	5	220	76490	5	201	76630	1	54	76731	1	58	76858	5	158	76966	1	64
75871	5	208	76097	5	155	76379	5	220	76491	5	201	76631	1	54	76732	1	58	76859	5	158	76967	1	64
75872	5	208	76128	5	152	76380	5	220	76492	5	232	76632	1	54	76733	1	58	76860	5	158	76968	1	64
75873	5	208	76129	5	152	76381	5	220	76495	5	232	76633	1	54	76735	1	59	76861	5	158	76969	1	64
75874	5	208	76130	5	150	76382	5	220	76496	5	217	76634	1	54	76736	1	59	76862	5	158	76970	1	64
75875	5	208	76131	5	150	76383	5	220	76497	5	217	76635	1	54	76737	1	57	76863	5	158	76971	1	64
75876	5	208	76133	5	190	76384	5	220	76498	5	217	76636	1	54	76738	1	54	76864	5	158	76972	1	64
75877	5	208	76134	5	190	76385	5	220	76499	5	217	76637	1	54	76740	5	151	76865	5	158	76973	1	64
75878	5	208	76135	5	190	76386	5	220	76500	5	217	76638	1	55	76741	5	151	76866	5	158	76974	1	64
75879	5	208	76136	5	190	76387	5	220	76501	5	217	76639	1	55	76745	5	151	76867	5	158	76975	1	64
75880	5	208	76137	5	190	76400	5	161	76502	5	217	76640	1	55	76746	5	151	76868	5	158	76976	1	64
75881	5	208	76138	5	190	76401	5	161	76503	5	217	76641	1	55	76751	5	182	76869	5	158	76977	1	64
75882	5	208	76139	5	190	76402	5	161	76504	5	217	76642	1	55	76752	5	182	76870	5	158	76978	1	65
75883	5	208	76140	5	190	76403	5	161	76505	5	217	76643	1	55	76753	5	182	76871	5	155	76979	1	65
75884	5	221	76141	5	190	76404	5	161	76506	5	217	76644	1	55	76754	5	182	76872	5	155	76980	1	65
75885	5	221	76142	5	190	76405	5	161	76507	5	217	76645	1	55	76755	5	160	76873	5	155	76981	1	65
75886	5	221	76143	5	190	76406	5	161	76508	5	217	76646	1	55	76756	5	160	76874	5	155	76982	1	65
75887	5	221	76144	5	190	76407	5	161	76509	5	217	76647	1	55	76758	1	23	76875	5	155	76983	1	65
75888	5	221	76145	1	23	76408	5	161	76510	5	217	76648	1	55	76759	1	23	76876	5	155	76984	1	63
75889	5	221	76147	1	23	76409	5	161	76511	5	217	76649	1	55	76760	1	23	76877	5	155	76985	1	63
75890	5	221	76202	5	219	76410	5	162	76512	5	221	76650	1	55	76761	1	23	76878	5	155	76986	1	63
75891	5	221	76203	5	219	76411	5	162	76513	5	221	76651	1	58	76762	1	23	76879	5	155	76987	1	63
75892	5	221	76204	5	219	76412	5	162	76514	5	221	76652	1	58	76766	5	219	76880	5	155	76988	1	63
75893	5	221	76205	5	219	76413	5	162	76515	5	221	76653	1	58	76767	5	219	76881	5	155	76989	1	63
75894	5	221	76206	5	219	76414	5	162	76516	5	221	76654	1	58	76768	5	219	76882	5	155	76990	5	219
75895	5	221	76207	5	219	76415	5	162	76517	5	221	76655	1	59	76769	5	219	76885	5	155	76991	5	219
75896	5	221	76208	5	219	76416	5	162	76518	5	232	76656	1	59	76770	5	219	76886	5	155	76992	5	219
75897	5	221	76209	5	219	76417	5	162	76519	5	232	76657	1	59	76771	5	219	76887	5	156	76993	5	219
75898	5	221	76210	5	219	76418	5	162	76520	5	232	76658	1	59	76772	5	219	76888	5	156	76994	5	219
75899	5	221	76211	5	219	76419	5	162	76521	5	232	76659	1	59	76773	5	219	76889	5	156	76995	5	219
75900	5	225	76212	5	219	76420	5	162	76522	5	232	76660	1	59	76775	5	204	76890	5	156	76996	5	219
75901	5	225	76213	5	219	76421	5	162	76523	5	167	76661	1	59	76781	5	165	76891	5	159	76997	5	219
75902	5	225	76214	5	219	76422	5	162	76524	5	167	76662	1	59	76782	5	165	76892	5	159	76998	5	219
75903	5	225	76215	5	219	76423	5	162	76525	5	232	76663	1	60	76783	5	165	76893	5	159	76999	5	219
75904	5	225	76216	5	219	76424	5	162	76539	1	20	76664	1	60	76784	5	165	76894	5	159	77000	5	181
75905	5	225	76217	5	219	76425	5	162	76544	1	19	76665	1	60	76785	5	165	76895	5	160	77001	5	181
75906	5	225	76218	5	219	76426	5	162	76545	5	247	76666	1	60	76786	5	165	76896	5	160	77002	5	181
75907	5	225	76219	5	219	76427	5	162	76546	5	247	76667	1	60	76787	5	165	76897	5	160	77003	5	181
75908	5	225	76220	5	219	76428	5	162	76547	5	254	76668	1	60	76788	5	165	76898	5	165	77004	5	181
75909	5	225	76221	5	219	76429	5	163	76548	5	254	76669	1	60	76789	5	165	76899	5	165	77005	5	181
75910	5	225	76222	5	219	76430	5	162	76549	1	19	76670	1	60	76790	5	165	76903	1	62	77006	5	181
75911	5	225	76223	5	219	76431	5	163	76550	1	24	7											







COD.	CAP.	PAG.	COD.	CAP.	PAG.	COD.	CAP.	PAG.	COD.	CAP.	PAG.	COD.	CAP.	PAG.	COD.	CAP.	PAG.	COD.	CAP.	PAG.	COD.	CAP.	PAG.
78554	5	223	78648	5	228	78742	5	192	78836	5	192	78930	5	195	79101	5	151	79308	4	139	79443	9	366
78555	5	223	78649	5	228	78743	5	192	78837	5	192	78931	5	195	79128	5	151	79309	4	139	79444	9	366
78556	5	223	78650	5	228	78744	5	192	78838	5	192	78932	5	195	79129	5	151	79310	4	139	79445	9	366
78557	5	223	78651	5	228	78745	5	192	78839	5	192	78933	5	195	79145	5	151	79311	4	139	79446	9	366
78558	5	223	78652	5	228	78746	5	192	78840	5	192	78934	5	195	79146	5	151	79312	4	139	79447	5	157
78559	5	224	78653	5	228	78747	5	192	78841	5	192	78935	5	195	79147	4	138	79313	4	139	79448	9	365
78560	5	224	78654	5	228	78748	5	192	78842	5	192	78936	5	195	79148	4	138	79314	4	139	79449	5	157
78561	5	224	78655	5	228	78749	5	192	78843	5	192	78937	5	195	79149	4	138	79315	4	139	79450	5	270
78562	5	224	78656	5	228	78750	5	192	78844	5	192	78938	5	195	79150	4	138	79316	4	139	79451	5	270
78563	5	224	78657	5	228	78751	5	192	78845	5	192	78939	5	195	79151	4	138	79317	4	139	79452	5	270
78564	5	224	78658	5	228	78752	5	192	78846	5	192	78940	5	195	79152	4	138	79318	4	139	79453	5	270
78565	5	224	78659	5	228	78753	5	192	78847	5	192	78941	5	195	79153	4	138	79319	4	139	79454	5	270
78566	5	224	78660	5	228	78754	5	192	78848	5	192	78942	5	195	79154	4	138	79320	4	139	79455	5	270
78567	5	224	78661	5	228	78755	5	192	78849	5	192	78943	5	195	79155	4	138	79321	4	139	79456	5	270
78568	5	224	78662	5	228	78756	5	192	78850	5	192	78944	5	195	79156	4	138	79322	4	139	79457	5	270
78569	5	224	78663	5	228	78757	5	192	78851	5	192	78945	5	195	79157	4	138	79323	4	139	79458	5	270
78570	5	224	78664	5	228	78758	5	192	78852	5	192	78946	5	195	79158	4	138	79324	4	139	79459	5	270
78571	5	224	78665	5	228	78759	5	192	78853	5	192	78947	5	195	79159	4	138	79325	4	139	79460	5	270
78572	5	224	78666	5	228	78760	5	192	78854	5	192	78948	5	195	79160	4	138	79326	4	139	79461	5	270
78573	5	224	78667	5	227	78761	5	192	78855	5	192	78949	5	195	79161	4	138	79327	4	139	79462	5	270
78574	5	224	78668	5	227	78762	5	192	78856	5	192	78950	5	195	79162	4	138	79328	4	139	79463	5	153
78575	5	224	78669	5	227	78763	5	192	78857	5	195	78951	5	195	79163	1	54	79329	4	139	79464	5	153
78576	5	224	78670	5	227	78764	5	192	78858	5	195	78952	5	195	79164	1	54	79331	4	139	79465	1	63
78577	5	224	78671	5	227	78765	5	192	78859	5	195	78953	5	195	79165	1	55	79332	4	139	79466	1	62
78578	5	224	78672	5	227	78766	5	192	78860	5	195	78954	5	195	79166	1	55	79333	4	139	79467	1	63
78579	5	224	78673	5	227	78767	5	192	78861	5	195	78955	5	195	79211	5	197	79334	4	139	79468	1	62
78580	5	224	78674	5	227	78768	5	192	78862	5	195	78956	5	195	79212	5	197	79335	4	139	79470	1	25
78581	5	224	78675	5	227	78769	5	192	78863	5	195	78957	5	195	79220	5	152	79336	4	139	79471	1	25
78582	5	224	78676	5	227	78770	5	192	78864	5	195	78958	5	195	79221	5	152	79337	4	139	79472	1	25
78583	5	224	78677	5	227	78771	5	192	78865	5	195	78959	5	195	79222	5	152	79338	4	139	79473	5	157
78584	5	224	78678	5	227	78772	5	192	78866	5	195	78960	5	195	79223	5	152	79339	4	139	79474	5	157
78585	5	224	78679	5	227	78773	5	192	78867	5	195	78961	5	195	79226	5	155	79340	4	139	79475	1	35
78586	5	224	78680	5	227	78774	5	192	78868	5	195	78962	5	195	79228	5	152	79341	4	139	79476	1	35
78587	5	224	78681	5	227	78775	5	192	78869	5	195	78967	5	246	79229	5	152	79342	4	139	79477	1	40
78588	5	224	78682	5	227	78776	5	192	78870	5	195	78968	5	246	79230	5	152	79343	4	139	79478	1	41
78589	5	224	78683	5	227	78777	5	192	78871	5	195	78975	5	158	79231	5	152	79344	4	139	79479	1	46
78590	5	224	78684	5	227	78778	5	192	78872	5	195	78976	5	158	79232	5	152	79345	4	139	79480	1	46
78591	5	224	78685	5	227	78779	5	192	78873	5	195	78983	5	198	79233	5	152	79346	4	139	79481	5	157
78592	5	224	78686	5	227	78780	5	192	78874	5	195	78984	5	198	79250	4	139	79347	4	139	79482	5	157
78593	5	224	78687	5	227	78781	5	192	78875	5	195	79028	5	158	79251	4	139	79348	4	139	79483	1	26
78594	5	224	78688	5	227	78782	5	192	78876	5	195	79029	5	158	79252	4	139	79349	4	139	79484	1	26
78595	5	227	78689	5	227	78783	5	192	78877	5	195	79030	4	137	79253	4	139	79350	4	139	79485	1	26
78596	5	227	78690	5	227	78784	5	192	78878	5	195	79031	4	137	79254	4	139	79351	4	139	79486	1	28
78597	5	227	78691	5	227	78785	5	192	78879	5	195	79032	4	137	79255	4	139	79352	4	139	79487	1	28
78598	5	227	78692	5	227	78786	5	192	78880	5	195	79033	4	137	79256	4	139	79353	4	139	79488	1	28
78599	5	227	78693	5	227	78787	5	192	78881	5	195	79036	4	137	79257	4	139	79354	4	139	79495	1	39
78600	5	227	78694	5	227	78788	5	192	78882	5	195	79037	4	137	79258	4	139	79355	4	139	79496	1	39
78601	5	227	78695	5	227	78789	5	192	78883	5	195	79038	4	137	79259	4	139	79356	4	139	79497	1	39
78602	5	227	78696	5	227	78790	5	192	78884	5	195	79039	4	137	79260	4	139	79358	4	138	79502	6	293
78603	5	227	78697	5	227	78791	5	192	78885	5	195	79040	4	137	79261	4	139	79359	4	138	79590	6	305
78604	5	227	78698	5	227	78792	5	192	78886	5	195	79041	4	137	79262	4	139	79361	4	138	79591	6	307
78605	5	227	78699	5	227	78793	5	192	78887	5	195	79042	4	137	79263	4	139	79362	4	138	79595	6	304
78606	5	227	78700	5	227	78794	5	192	78888	5	195	79043	4	137	79264	4	139	79363	4	138	79596	6	304
78607	5	227	78701	5	227	78795	5	192	78889	5	195	79044	4	137	79265	4	139	79364	4	138	79598	6	305
78608	5	227	78702	5	227	78796	5	192	78890	5	195	79045	4	137	79266	4	139	79370	1	30	79598	8	356
78609	5	227	78703	5	227	78797	5	192	78891	5	195	79046	4	137	79267	4	139	79371	1	30	79602	6	308
78610	5	227	78704	5	227	78798	5	192	78892	5	195	79047	4	137	79268	4	139	79372	1	30	79603	6	308
78611	5	227	78705	5	227	78799	5	192	78893	5	195	79048	4	137	79269	4	139	79373	1	30	79604	6	309
78612	5	227	78706	5	227	78800	5	192	78894	5	195	79049	4	137	79270	4	139	79374	1	30	79605	6	311
78613	5	227	78707	5	227	78801	5	192	78895	5	195	79050	4	137	79271	4	139	79375	1	30	79606	6	312
78614	5	227	78708	5	227	78802	5	192	78896	5	195	79051	4	137	79272	4	139	79376	1	30	79607	6	317
78615	5	227	78709	5	227	78803	5	192	78897	5	195	79052	4	137	79273	4	139	79377	1	30	79608	6	317
786																							

COD.	CAP.	PAG.	COD.	CAP.	PAG.	COD.	CAP.	PAG.	COD.	CAP.	PAG.	COD.	CAP.	PAG.	COD.	CAP.	PAG.	COD.	CAP.	PAG.			
79731	6	299	79850	5	226	89132	3	95	89187	3	95	AD361187	3	94	AD500717	3	128	AD574587	3	92	AD607707	3	90
79732	6	297	79851	5	226	89133	3	95	89188	3	93	AD361197	3	94	AD500727	3	129	AD574597	3	92	AD607717	3	90
79733	6	297	79852	5	226	89133	3	95	89188	3	95	AD361207	3	94	AD500737	3	129	AD574607	3	92	AD607727	3	90
79734	1	50	79853	5	226	89134	3	95	89189	3	93	AD361217	3	94	AD500747	3	129	AD574617	3	92	AD607737	3	90
79735	1	50	79854	5	226	89134	3	95	89189	3	95	AD361227	3	94	AD500757	3	129	AD574627	3	92	AD607747	3	90
79736	1	50	79855	5	226	89135	3	93	89190	3	93	AD361237	3	94	AD500767	3	129	AD574657	3	92	AD607757	3	90
79737	1	50	79856	5	226	89135	3	95	89190	3	95	AD361247	3	94	AD500777	3	129	AD574667	3	92	AD607767	3	90
79738	1	50	79857	5	226	89136	3	95	89191	3	93	AD361257	3	94	AD500787	3	130	AD574677	3	92	AD607777	3	90
79739	1	50	79858	5	226	89136	3	95	89191	3	95	AD361267	3	94	AD500797	3	130	AD574687	3	92	AD607787	3	90
79740	1	50	79859	5	226	89137	3	93	89192	3	93	AD361277	3	94	AD500807	3	130	AD574697	3	92	AD607797	3	90
79741	1	50	79860	5	226	89137	3	95	89192	3	95	AD361287	3	94	AD500817	3	130	AD574707	3	92	AD607807	3	90
79742	1	50	79861	5	226	89138	3	93	89193	3	93	AD361297	3	94	AD500827	3	130	AD574717	3	92	AD607817	3	90
79743	1	50	79862	5	226	89138	3	95	89193	3	95	AD361307	3	94	AD553307	3	99	AD574727	3	92	AD607827	3	90
79744	1	50	79863	5	226	89139	3	93	89194	3	93	AD361317	3	94	AD553317	3	99	AD574737	3	92	AD607857	3	90
79745	1	50	79864	5	226	89139	3	95	89194	3	95	AD361327	3	94	AD553327	3	99	AD574747	3	92	AD607887	3	90
79746	1	50	79865	5	226	89140	3	93	89195	3	93	AD361337	3	94	AD553337	3	99	AD574757	3	92	AD607897	3	90
79747	1	50	79866	5	226	89140	3	95	89195	3	95	AD361347	3	94	AD553347	3	99	AD574767	3	92	AD607907	3	90
79748	1	50	79867	5	226	89141	3	93	89196	3	95	AD361357	3	94	AD553357	3	99	AD574777	3	92	AD607927	3	90
79749	1	50	79868	5	226	89141	3	95	89197	3	93	AD361367	3	94	AD553367	3	99	AD574787	3	92	AD608977	3	97
79750	1	50	79869	5	225	89142	3	93	89197	3	95	AD361377	3	94	AD553377	3	99	AD574797	3	92	AD608987	3	97
79751	1	50	79870	5	225	89142	3	95	89198	3	93	AD361387	3	94	AD553387	3	99	AD574807	3	92	AD608997	3	97
79752	1	50	79871	5	225	89143	3	93	89198	3	95	AD361397	3	94	AD553397	3	99	AD574817	3	92	AD609577	3	97
79753	1	50	79872	5	225	89143	3	95	89199	3	93	AD361407	3	94	AD553407	3	99	AD574827	3	92	AD609587	3	97
79754	1	50	79873	5	225	89144	3	93	89199	3	95	AD361417	3	94	AD553417	3	99	AD574837	3	92	AD609597	3	97
79755	1	50	79874	5	225	89144	3	95	89200	3	93	AD361427	3	94	AD553447	3	99	AD574847	3	92	AD609607	3	97
79756	1	50	79875	5	225	89145	3	93	89200	3	95	AD361437	3	94	AD553457	3	99	AD574857	3	92	AD609617	3	97
79757	1	50	79876	5	225	89145	3	95	89201	3	93	AD361447	3	94	AD553467	3	99	AD574867	3	92	AD609627	3	97
79758	1	50	79877	5	225	89146	3	95	89201	3	95	AD361457	3	94	AD553477	3	99	AD574877	3	92	AD610017	3	106
79759	1	50	79878	5	225	89147	3	95	89202	3	93	AD361467	3	94	AD553487	3	99	AD574887	3	92	AD610027	3	106
79760	6	315	79879	5	221	89148	3	93	89202	3	95	AD361507	3	94	AD553497	3	99	AD574897	3	92	AD610037	3	106
79761	6	316	79880	5	221	89148	3	95	89203	3	93	AD361517	3	94	AD553527	3	100	AD574907	3	92	AD610047	3	106
79762	6	316	79881	5	221	89149	3	93	89203	3	95	AD361527	3	94	AD553547	3	100	AD574917	3	92	AD610147	3	106
79763	6	316	79882	5	221	89149	3	95	89204	3	93	AD361537	3	94	AD553557	3	100	AD574927	3	92	AD610157	3	106
79764	6	316	79883	5	222	89150	3	95	89204	3	95	AD361547	3	94	AD553567	3	100	AD574937	3	92	AD610167	3	106
79765	6	316	79884	5	222	89151	3	95	89205	3	93	AD361557	3	94	AD553577	3	100	AD574947	3	92	AD610177	3	106
79766	6	316	79885	5	222	89152	3	93	89205	3	95	AD361567	3	94	AD553587	3	100	AD574957	3	92	AD610237	3	106
79767	6	316	79886	5	222	89152	3	95	89206	3	93	AD361577	3	94	AD553597	3	100	AD585817	3	92	AD610247	3	106
79768	6	316	79887	5	222	89153	3	93	89206	3	95	AD361587	3	94	AD553607	3	100	AD585827	3	92	AD610267	3	106
79769	6	316	79888	5	222	89153	3	95	89207	3	93	AD361597	3	94	AD553617	3	100	AD585837	3	92	AD610357	3	107
79770	6	316	79889	1	31	89154	3	93	89207	3	95	AD361607	3	94	AD553647	3	101	AD585847	3	92	AD610447	3	106
79772	6	316	79890	1	31	89154	3	95	89208	3	93	AD361617	3	94	AD553657	3	101	AD585857	3	92	AD611097	3	90
79773	6	316	79891	1	31	89155	3	93	89208	3	95	AD361627	3	94	AD553687	3	101	AD585867	3	92	AD611107	3	90
79774	6	316	79900	8	347	89155	3	95	89209	3	93	AD361637	3	94	AD553697	3	101	AD585877	3	92	AD611117	3	90
79775	6	316	79901	8	347	89156	3	95	89209	3	95	AD361647	3	94	AD553717	3	102	AD585887	3	92	AD611127	3	90
79776	6	316	79902	6	320	89157	3	93	89210	3	95	AD361657	3	94	AD553737	3	102	AD586417	3	123	AD611137	3	90
79777	6	316	79902	8	349	89157	3	95	89211	3	93	AD361667	3	94	AD553747	3	102	AD603007	3	96	AD611157	3	90
79778	6	316	79903	6	320	89158	3	95	89211	3	95	AD361677	3	94	AD553757	3	102	AD603017	3	96	AD612997	3	106
79779	6	316	79903	8	349	89159	3	93	89212	3	93	AD361687	3	94	AD553767	3	102	AD603027	3	96	AD613017	3	90
79780	6	316	79904	6	309	89159	3	95	89212	3	95	AD361697	3	94	AD553787	3	102	AD603037	3	96	AD613027	3	90
79784	6	291	79904	8	351	89160	3	95	89213	3	93	AD361707	3	94	AD553797	3	102	AD603047	3	96	AD613037	3	90
79785	6	324	79905	6	309	89161	3	93	89213	3	95	AD361717	3	94	AD553807	3	102	AD603057	3	96	AD613047	3	90
79788	6	289	79905	8	351	89161	3	95	89214	3	93	AD361727	3	94	AD553827	3	102	AD603067	3	96	AD613057	3	90
79789	6	287	79906	6	310	89162	3	93	89214	3	95	AD361737	3	94	AD553837	3	102	AD603077	3	96	AD613067	3	90
79790	6	288	79906	8	352	89162	3	95	89215	3	93	AD361747	3	94	AD562957	3	92	AD603087	3	96	AD613087	3	90
79793	6	288	79907	6	310	89163	3	93	89215	3	95	AD361757	3	94	AD562967	3	92	AD603097	3	96	AD613097	3	90
79799	1	52	79907	8	352	89163	3	95	89216	3	93	AD361767	3	94	AD562977	3	92	AD603107	3	96	AD613107	3	90
79800	1	52	79908	8	353	89164	3	95	89216	3	95	AD361777	3	94	AD574047	3	92	AD603117	3	96	AD613677	3	107
79801	1	52	79908	6	311	89165	3	93	89217	3	93	AD361787	3	94	AD574057	3	92	AD603127	3	96	AD613687	3	106
79802	1	52	79909	8	348	89165	3	95	89217	3	95	AD361797	3	94	AD574067	3	92	AD603137	3	96	AD613697	3	106
79803	1	52	79911	8	348	89166	3	93	89218	3	93	AD361807	3	94	AD574077	3	92	AD603147	3	96	AD614057	3	106
79804	1	52	79912	8	353	89166	3	95	89219	3	93	AD361817	3	94	AD574087	3	92	AD603407	3	97	AD614067	3	106
79805	1	52	79913	6	327																		

COD.	CAP.	PAG.	COD.	CAP.	PAG.	COD.	CAP.	PAG.	COD.	CAP.	PAG.	COD.	CAP.	PAG.	COD.	CAP.	PAG.	COD.	CAP.	PAG.	COD.	CAP.	PAG.
AD617347	3	97	AD635047	3	103	AD636887	3	104	AD664777	3	101	AD679437	3	96	AD730807	3	117	AD732127	3	119	AD750837	3	121
AD617357	3	97	AD635057	3	103	AD636927	3	105	AD664787	3	101	AD679447	3	96	AD730817	3	117	AD732137	3	119	AD750847	3	121
AD617367	3	97	AD635067	3	103	AD636937	3	105	AD664797	3	101	AD679457	3	96	AD730827	3	117	AD732147	3	119	AD750977	3	121
AD617377	3	97	AD635077	3	103	AD636967	3	105	AD664807	3	101	AD695347	3	89	AD730837	3	117	AD732157	3	119	AD751327	3	122
AD617387	3	97	AD635087	3	103	AD636977	3	105	AD664817	3	101	AD695357	3	89	AD730867	3	117	AD732167	3	119	AD751337	3	122
AD617397	3	97	AD635277	3	103	AD637007	3	105	AD664827	3	101	AD696627	3	108	AD730887	3	115	AD732177	3	119	AD751367	3	122
AD617407	3	97	AD635287	3	103	AD637017	3	105	AD664837	3	101	AD696637	3	108	AD730907	3	117	AD732187	3	119	AD751387	3	122
AD617417	3	97	AD635297	3	103	AD637067	3	105	AD664847	3	101	AD696647	3	108	AD730917	3	117	AD732197	3	119	AD751567	3	123
AD617427	3	97	AD635307	3	103	AD637077	3	105	AD664857	3	101	AD696667	3	108	AD730927	3	117	AD732207	3	119	AD751577	3	123
AD617437	3	97	AD635317	3	103	AD637087	3	105	AD664867	3	101	AD696677	3	108	AD730937	3	117	AD732217	3	119	AD751587	3	123
AD617447	3	97	AD635327	3	103	AD637097	3	105	AD664877	3	101	AD696687	3	108	AD730947	3	117	AD732227	3	119	AD751597	3	123
AD617457	3	97	AD635337	3	103	AD637127	3	105	AD664887	3	101	AD696697	3	108	AD730957	3	117	AD732237	3	119	AD751727	3	122
AD617467	3	97	AD635347	3	103	AD637137	3	105	AD664897	3	101	AD696737	3	108	AD730967	3	117	AD732247	3	119	AD751737	3	122
AD617477	3	97	AD635357	3	103	AD637427	3	107	AD664907	3	101	AD696747	3	108	AD730977	3	117	AD732257	3	119	AD751747	3	122
AD617487	3	97	AD635367	3	103	AD638767	3	107	AD664917	3	101	AD696847	3	109	AD730987	3	117	AD732267	3	119	AD751757	3	122
AD617497	3	97	AD635377	3	103	AD638777	3	107	AD664927	3	101	AD696857	3	109	AD730997	3	117	AD732277	3	119	AD751767	3	122
AD617507	3	97	AD635387	3	103	AD638787	3	107	AD664937	3	101	AD696867	3	109	AD731007	3	117	AD732287	3	119	AD751777	3	122
AD617557	3	98	AD635397	3	103	AD639617	3	96	AD664947	3	101	AD696877	3	109	AD731017	3	117	AD732297	3	119	AD751787	3	122
AD617767	3	98	AD635407	3	103	AD650767	3	91	AD664957	3	101	AD696887	3	109	AD731027	3	117	AD733477	3	117	AD751797	3	122
AD617777	3	98	AD635417	3	103	AD650777	3	91	AD664967	3	101	AD696897	3	109	AD731037	3	117	AD733487	3	117	AD752017	3	123
AD617787	3	98	AD635427	3	103	AD650787	3	91	AD664977	3	101	AD697047	3	109	AD731047	3	117	AD733497	3	117	AD752027	3	123
AD617797	3	98	AD635437	3	103	AD650797	3	91	AD664987	3	101	AD697057	3	109	AD731057	3	117	AD733507	3	117	AD752037	3	123
AD617807	3	98	AD635447	3	103	AD650807	3	91	AD664997	3	101	AD697067	3	109	AD731067	3	117	AD733517	3	117	AD761457	3	116
AD617817	3	98	AD635637	3	104	AD650817	3	91	AD665017	3	101	AD697077	3	109	AD731077	3	117	AD733527	3	117	AD761477	3	115
AD617827	3	98	AD635647	3	104	AD651457	3	110	AD665027	3	101	AD697087	3	109	AD731087	3	117	AD733537	3	117	AD765507	3	116
AD617837	3	98	AD635657	3	104	AD651487	3	110	AD665037	3	101	AD697157	3	109	AD731097	3	117	AD733547	3	117	AD765517	3	116
AD617847	3	98	AD635667	3	104	AD651587	3	111	AD665107	3	102	AD697167	3	109	AD731107	3	117	AD733557	3	117	AD765527	3	116
AD617857	3	98	AD635677	3	104	AD651597	3	111	AD665117	3	102	AD697177	3	109	AD731117	3	117	AD733567	3	118	AD765537	3	116
AD617867	3	98	AD635687	3	104	AD653527	3	91	AD665127	3	102	AD697197	3	109	AD731127	3	117	AD733577	3	118	AD765547	3	116
AD617877	3	98	AD635697	3	104	AD653537	3	91	AD665137	3	102	AD697317	3	108	AD731137	3	117	AD733587	3	118	AD765557	3	116
AD617887	3	98	AD635707	3	104	AD653547	3	91	AD665147	3	102	AD697327	3	108	AD731147	3	117	AD733597	3	118	AD765567	3	116
AD620917	3	89	AD635717	3	104	AD653587	3	110	AD665157	3	102	AD697337	3	108	AD731157	3	117	AD733607	3	118	AD765577	3	116
AD620977	3	107	AD635727	3	104	AD655707	3	111	AD665167	3	102	AD697347	3	108	AD731167	3	117	AD733617	3	118	AD765637	3	116
AD621067	3	89	AD635737	3	104	AD655717	3	111	AD665177	3	102	AD697357	3	108	AD731177	3	117	AD733637	3	118	AD765787	3	116
AD621517	3	89	AD635747	3	104	AD655767	3	111	AD665187	3	102	AD697367	3	108	AD731187	3	117	AD746647	3	122	AD765797	3	116
AD621597	3	107	AD635757	3	104	AD659167	3	91	AD665197	3	102	AD697377	3	108	AD731197	3	117	AD746657	3	122	AD765807	3	116
AD622327	3	107	AD635767	3	104	AD659177	3	91	AD665207	3	102	AD697387	3	109	AD731207	3	118	AD746667	3	122	AD765817	3	116
AD622337	3	107	AD635777	3	104	AD660727	3	111	AD665217	3	102	AD697397	3	109	AD731217	3	118	AD746677	3	122	AD765827	3	112
AD622347	3	107	AD635787	3	104	AD660737	3	111	AD665257	3	102	AD697407	3	109	AD731227	3	118	AD746687	3	122	AD765837	3	112
AD622417	3	88	AD635797	3	104	AD664007	3	99	AD665267	3	102	AD697417	3	109	AD731237	3	118	AD746697	3	122	AD765847	3	112
AD622437	3	88	AD635807	3	104	AD664017	3	99	AD665277	3	102	AD697437	3	109	AD731247	3	118	AD746707	3	122	AD765897	3	112
AD622477	3	88	AD635997	3	104	AD664027	3	99	AD665307	3	101	AD697447	3	109	AD731257	3	118	AD746717	3	122	AD765907	3	112
AD622977	3	89	AD636007	3	104	AD664037	3	99	AD665317	3	101	AD697457	3	109	AD731267	3	118	AD746727	3	122	AD765917	3	112
AD622987	3	89	AD636017	3	104	AD664047	3	99	AD665327	3	101	AD697467	3	109	AD731277	3	118	AD746737	3	122	AD765927	3	112
AD622997	3	86	AD636027	3	104	AD664057	3	99	AD668467	3	103	AD697477	3	109	AD731287	3	118	AD746747	3	122	AD765937	3	112
AD623007	3	86	AD636037	3	104	AD664067	3	99	AD668487	3	103	AD697567	3	109	AD731297	3	118	AD746757	3	122	AD765947	3	112
AD623317	3	87	AD636047	3	104	AD664077	3	99	AD668507	3	103	AD705047	3	110	AD731307	3	118	AD746767	3	122	AD765957	3	112
AD623327	3	87	AD636057	3	104	AD664087	3	99	AD668517	3	103	AD730017	3	115	AD731317	3	118	AD746777	3	122	AD765967	3	112
AD623337	3	87	AD636067	3	104	AD664097	3	99	AD668527	3	103	AD730047	3	115	AD731337	3	118	AD746787	3	122	AD765977	3	112
AD623377	3	87	AD636077	3	104	AD664107	3	99	AD671927	3	102	AD730057	3	115	AD731347	3	118	AD746987	3	122	AD765987	3	112
AD623387	3	87	AD636087	3	104	AD664117	3	100	AD671937	3	102	AD730087	3	115	AD731357	3	118	AD746997	3	122	AD765997	3	112
AD623397	3	87	AD636097	3	104	AD664127	3	100	AD671957	3	108	AD730097	3	115	AD731367	3	118	AD747007	3	122	AD766007	3	113
AD623407	3	87	AD636107	3	104	AD664137	3	99	AD678437	3	98	AD730107	3	114	AD731457	3	118	AD747017	3	122	AD766027	3	113
AD623417	3	87	AD636117	3	104	AD664147	3	99	AD678447	3	98	AD730117	3	114	AD731477	3	118	AD747027	3	122	AD766037	3	113
AD623427	3	87	AD636127	3	104	AD664157	3	99	AD678457	3	98	AD730207	3	115	AD731507	3	118	AD747037	3	122	AD766067	3	113
AD623437	3	87	AD636137	3	104	AD664167	3	99	AD678467	3	98	AD730217	3	115	AD731527	3	118	AD747047	3	122	AD766077	3	113
AD623447	3	87	AD636147	3	104	AD664177	3	99	AD678477	3	98	AD730297	3	123	AD731607	3	118	AD747057	3	122	AD766097	3	113
AD623457	3	88	AD636157	3	104	AD664187	3	99	AD678487	3	98	AD730307	3	123	AD731707	3	119	AD747067	3	122	AD766117	3	113

COD.	CAP.	PAG.
AD766487	3	121
AD766497	3	121
AD766507	3	121
AD766517	3	122
AD766527	3	122
AD766537	3	122
AD766547	3	122
AD766557	3	123
AD766567	3	123
AD766577	3	123
AD766587	3	123
AD766597	3	123
AD766607	3	123
AD766617	3	123
AD766627	3	123
AD767307	3	122
AD767317	3	122
AD767327	3	122
AD767337	3	122
AD767357	3	123
AD767367	3	123
AD767387	3	120
AD767587	3	116
AD767597	3	116
AD767607	3	116
AD767617	3	116
AD767627	3	116
AD790577	3	114
AD790587	3	114
AD790597	3	114
AD791637	3	120
AD791647	3	120
AD791657	3	121
AD791667	3	121
AD793707	3	119
AD793717	3	119
AD793727	3	119
AD793737	3	119
AD793747	3	119
AD793757	3	119
AD793767	3	119
AD793777	3	119
AD793787	3	119
AD793797	3	119
AD793807	3	119
AD793817	3	119
AD793827	3	119
AD793837	3	119
AD793847	3	119
AD793857	3	119
AD793867	3	119
AD793877	3	119
AD793907	3	120
AD793917	3	120
AD793927	3	120
AD793937	3	120











to the  
Management  
Quality

# MEDIDAS PARA TORNILLOS MÉTRICOS Y PARES DE APRIETE

## MEASURES FOR METRIC SCREWS AND TIGHTENING VALUES

### MESURES POUR TOURNEVIS MÉTRIQUES ET COUPLES DE SERRAGE

MEDIDA NOMINAL NOMINAL SIZE MESURE NOMINALE	CABEZA HEXAGONAL /HEXAGONAL HEAD / TÊTE HEXAGONALE			CABEZA CILÍNDRICA / HEX. SOCKET SCREW / TÊTE CYLINDRIQUE			TORX **		TRIPLE SQUARE	PAR DE APRIETE RECOMENDADO RECOMMENDED TIGHTENING TORQUE / COUPLE DE SERRAGE RECOMMANDÉ (NM)					
										GRADO STRENGTH GRADE					
	ESTÁNDAR STANDARD STANDARD	COMPACTA COMPACT COMPACT	ALTA RESISTENCIA HIGH RESISTANCE HAUTE RESISTANCE	ESTÁNDAR STANDARD STANDARD	CABEZA GOTA BUTTON HEAD TÊTE GOUTTE	ESPÁRRAGO ALLEN SET SCREW GOUPILLE ALLEN	T	E	XZN	4.6	6.8	8.8	10.9	12.9	
M2	4			0,5		0,9	T6 T8				0,12	0,24	0,32	0,45	0,54
M2,5	5			2		1,3	T8		M3		0,25	0,49	0,65	0,92	1,1
M3	5.5			2,5	2	1,5	T10	E4	M3		0,43	0,87	1,16	1,63	1,96
M3,5	(6)						T15				0,68	1,37	1,82	2,56	3,08
M4	7			3	2,5	2	T20 T25	E5	M4		1,01	2,02	2,7	3,79	4,54
M5	8			4	3	2,5	T25 T27	E6	M5		2,04	4,09	5,47	7,67	9,18
M6	10			5	4	3	T30	E8	M6		3,47	6,97	9,27	13	15,6
M7	11						T40	E8			5,85	11,6	15,5	21,8	26,2
M8	13	(12)		6	5	4	T40 T45	E10	M8		8,41	16,9	22,5	31,6	37,9
M10	16 (17)	(14)		8	6	5	T50	E12	M10		16,7	33,4	44,5	62,6	75,2
M12	18 (19)	(17)	21 (22)	10	8	6	T55	E14	M12		29,1	58,3	77,6	109	131
M14	21 (22)	(19)		12			T55 T60	E14 E18	M14		46,4	92,7	124	174	209
M16	24	(22)	27	14	10	8	T60 T70	E16 E20	M16		72,3	145	194	271	325
M18	27	(24)		(14)			T70 T80	E24	M18		100	199	266	373	447
M20	30 (32)	(27) (29)	32	17	12	10	T80 T90	E24			141	282	376	529	635
M22	34 (32) (35)	(30) (32)	36	(17)			T90 T100	E28			192	384	511	720	865
M24	36 (38)	(32) (35)	41	19		12	T100	E32			244	488	650	915	1100
M27	41	(36)	46	(19)				E32			358	713	951	1340	1610
M30	46	(41)	50	22				E36			484	971	1290	1820	2180
M33	50	(46)		(24)				E40			661	1320	1760	2470	2970
M36	55 (54)	(50)		27				E44			848	1690	2260	3180	3810
M39	60 (58)	(55)		(27)							1100	2190	2920	4110	4930
M42	65 (63)			32							1350	2710	3610	5080	6080
M45	70 (67)			(32)							1700	3400	4540	6370	7630
M48	75 (71)			36							2030	4060	5440	7620	9120
M52	80 (77)			(36)							2640	5290	7040	9880	11800
M56	85			41							3270	6560	8710	12300	14800
M60	90										4080	8180	10900	15300	18300
M64	95			46							4930	9890	13100	18500	22300
M68	(100)										5970	12000	16000	22500	27000

\*Para tornillos TORX® (Marca registrada por Acument Intellectual Properties, LLC, Troy, Mich., US)

\*For screws TORX® (Acument Intellectual Properties, LLC, Troy, Mich., US registered trademark)

\*Pour vis TORX® (Marque enregistrée par Acument Intellectual Properties, LLC, Troy, Mich., US)

# EQUIVALENCIAS

# EQUIVALENCES

# ÉQUIVALENCES

Tamaño de la boca Size of the jaws Dimension de la bouche		Llave Wrench Clé			Tuerca o perno común Nut or bolt common Écrou ou boulon basique
mm	Pulgadas Inches Pouces	Métrica Metric Métrique AF: Entre caras Across flats Entre têtes	Pulgadas Inches Pouces AF: Entre caras Across flats Entre têtes	Británica British Britannique	(* No recomendados) (* Non recommended) (* Non recommandés)
2,97	0,117			10BA	
3,2	0,126	3,2 mm			M1.6
3,33	0,131			9BA	
3,86	0,152			8BA	
3,97	0,156		5/32 AF		Nº 0 UNC
4	0,157	4 mm			M2
4,37	0,172			7BA	
4,76	0,188		3/16 AF		Nº 2 UNC
4,9	0,193			6BA	
5	0,197	5 mm			M2.5
5,5	0,217	5,5 mm			M3
5,56	0,219		7/32 AF		
5,59	0,22			5BA	
5,95	0,234		15/64 AF		
6	0,236	6 mm			M3.5*
6,3	0,248			4BA	
6,35	0,25		1/4 AF		Nº 4 UNC
7	0,276	7 mm			M4
7,14	0,281		9/32 AF		
7,16	0,282			3BA	
7,94	0,313		5/16 AF		Nº 6 y Nº 10 UNC UNC (perno / bolt / boulon)
8	0,315	8 mm			M5
8,23	0,324			2BA	
8,59	0,338			1/8 W; 3/16 BSF	
8,73	0,344		11/32 AF		Nº 8 UNC
9	0,354	9 mm			
9,27	0,365			1BA	
9,53	0,375		3/8 AF		Nº 10 UNC (tuerca / nut / écrou)
10	0,394	10 mm			M6
10,49	0,413			0BA	
11	0,433	11 mm			M7*
11,11	0,438		7/16 AF		1/4 UNF
11,3	0,445			3/16 W; 1/4 BSF	
12	0,472	12 mm			
12,7	0,5		1/2 AF		5/16 UNF
13	0,512	13 mm			M8
13,34	0,525			1/4 W; 5/16 BSF	
14	0,551	14 mm			
14,29	0,563		9/16 AF		3/8 UNF
15	0,591	15 mm			
15,24	0,6			5/16 W; 3/8 BSF	
15,88	0,625		5/8 AF		7/16 UNF (perno / bolt / boulon)
16	0,63	16 mm			
17	0,669	17 mm			M10
17,46	0,688		11/16 AF		7/16 UNF (tuerca / nut / écrou)
18	0,709	18 mm			
18,03	0,71			3/8 W; 7/16 BSF	
19	0,748	19 mm			M12
19,05	0,75		3/4 AF		1/2 UNF

Tamaño de la boca Size of the jaws Dimension de la bouche		Llave Wrench Clé			Tuerca o perno común Nut or bolt common Écrou ou boulon basique
mm	Pulgadas Inches Pouces	Métrica Metric Métrique AF: Entre caras Across flats Entre têtes	Pulgadas Inches Pouces AF: Entre caras Across flats Entre têtes	Británica British Britannique	(* No recomendados) (* Non recommended) (* Non recommandés)
20	0,787	20 mm			
20,64	0,813		13/16 AF		9/16 UNF (perno / bolt / boulon)
20,83	0,82			7/16 W; 1/2 BSF	
21	0,827	21 mm			
22	0,866	22 mm			M14*
22,23	0,875		7/8 AF		9/16 UNF (tuerca / nut / écrou)
23	0,906	23 mm			
23,37	0,92			1/2 W; 9/16 BSF	
23,81	0,938		15/16 AF		5/8 UNF
24	0,945	24 mm			M16
25	0,984	25 mm			
25,4	1		1 AF		
25,65	1,01			9/16 W; 5/8 BSF	
26	1,024	26 mm			
26,99	1,063		1-1/16 de AF		
27	1,063	27 mm			M18*
27,94	1,1			5/8 W; 11/16 BSF	
28	1,102	28 mm			
28,58	1,125		1-1/8 AF		3/4 UNF
30	1,181	30 mm			M20
30,48	1,2			11/16 W; 3/4 BSF	
31,75	1,25		1-1/4 AF		
32	1,26	32 mm			M22*
33,02	1,3			3/4 W; 7/8 FBS	
33,34	1,313		1-5/16 de AF		7/8 UNF
34	1,339	34 mm			
35,31	1,39			13/16 W	
36	1,417	36 mm			M24
36,51	1,438		1-7/16 de AF		
37,59	1,48			7/8 W; 1 BSF	
38	1,496	38 mm			
38,1	1,5		1-1/2 AF		1 UNF
40,13	1,58			15/16 W	
41	1,614	41 mm			M27*
41,28	1,625		1-5/8 AF		
42,42	1,67			1 W; 1-1/8 BSF	
42,86	1,688		1-11/16 AF		1-1/8 UNF
46	1,811	46 mm			M30
46,04	1,813		1-13/16 AF		
47,24	1,86			1-1/8 W; 1-1/4 BSF	
47,63	1,875		1-7/8 AF		1-1/4 UNF
50	1,969	50 mm			M33*
50,8	2		2 AF		
52,07	2,05			1-1/4 W; 1-3/8 BSF	
52,39	2,063		2-1/16 de AF		1-3/8 UNF
55	2,165	55 mm			M36
55,56	2,188		2-3/16 de AF		
56,39	2,22			1-3/8 W; 1-1/2 BSF	
57,15	2,25		2-1/4 AF		1-1/2 UNF
60	2,362	60 mm			M39*

**LA MÁS GALARDONADA**  
**THE MOST AWARDED**  
**LA PLUS PRIMÉE**

	<b>Producto Más Innovador (Feria NSC de Seguridad, San Diego, EEUU, 2019)</b> <i>"Best in Show" New Product Showcase Awards (National Safety Council 2019 Congress &amp; Expo, San Diego, USA)</i> Produit le plus innovateur (Salón NSC de Sécurité, San Diego, EUA, 2019)		<b>Premio al Producto Más Innovador, Ferroforma 2013</b> <i>Award to the Most Innovative Industrial Product, Ferroforma 2013</i> Prix au Produit le Plus Innovateur, Ferroforma 2013
	<b>Premio Banco Santander a la empresa del año, 2019</b> <i>Banco Santander Award to the Company, 2019</i> Prix Banco Santander à l'entreprise de l'année, 2019		<b>Certificado de Calidad BIKAIN, 2013</b> <i>BIKAIN certificate, 2013</i> Certificat de qualité BIKAIN, 2013
	<b>International Quality Innovation Award, Beijing 2019</b> <i>International Quality Innovation Award, Beijing 2019</i> International Quality Innovation Award, Beijing 2019		<b>Ruban d'Honneur, European Business Awards 2012/13</b> <i>Ruban d'Honneur, European Business Awards 2012/13</i> Ruban d'Honneur, European Business Awards 2012/13
	<b>Quality Innovation Award, Euskalit 2018</b> <i>Quality Innovation Award, Euskalit 2018</i> Quality Innovation Award, Euskalit 2018		<b>Premio Internacional al Mejor Modelo de Negocio, 2012</b> <i>International Award by Development Systems to the Best Business Model, 2012</i> Prix International au Meilleur Modèle d'Entreprise, 2012
	<b>Premio Confebask, Mejor Instructor, 2018</b> <i>Confebask Award, Best Instructor, 2018</i> Prix Confebask, Meilleur Instructeur, 2018		<b>Premio a la Internacionalización, Club de Exportadores e Inversores, 2011</b> <i>Internationalization Award by The Spanish Exporters and Investors Club, 2011</i> Prix de l'internationalisation, Club des Exportateurs et Investisseurs, 2011
	<b>Premio Pacto Verde a las buenas prácticas medioambientales, 2018</b> <i>Green Pact Award for good environmental practices, 2018</i> Prix Pacte Vert aux bonnes pratiques environnementales, 2018		<b>Premio Finalista en Innovación CEX Asociación Española de Centros de la Excelencia, 2011</b> <i>Finalist Award for Best Practice in Innovation 2011, by CEX Spanish Association of Centers of Excellence</i> Prix Finaliste en Innovation CEX Association Espagnole des Centres d'Excellence, 2011
	<b>Empresa del año 2018, El Correo - Banco Sabadell</b> <i>Company of the year 2018, El Correo - Banco Sabadell</i> Entreprise de l'année 2018, El Correo - Banco Sabadell		<b>Premio Nacional al Relevo Generacional, 2010</b> <i>Company Succession National Award, 2010</i> Prix national a la relève générationnel, 2010
	<b>Premio a la Innovación Industrial Vodafone-Deia, 2017</b> <i>Vodafone-Deia Industrial Innovation Award, 2017</i> Pris de l'innovation industrielle Vodafone-Deia 2017		<b>Premio Iberoamericano de la Calidad y Excelencia 2010, Premio Oro</b> <i>Iberoamerican Award for Quality Management &amp; Excellence 2010</i> Prix Ibéro-américain de la Qualité et l'Excellence 2010, Prix d'Or
	<b>Premio BANKIA-ACOCEx a la Trayectoria Internacional, 2016</b> <i>International Business Award BANKIA-ACOCEx, 2016</i> Prix BANKIA ACOCEX pour son Parcours International, 2016		<b>Medalla de Oro por la Oficina Nacional de la Normalización de Cuba, 2010</b> <i>Gold Medal, National Office of Standards and Normalization of Cuba, 2010</i> Médaille d'Or par le Bureau National de la Normalisation de Cuba, 2010
	<b>Quality Innovation Award, Euskalit 2016</b> <i>Quality Innovation Award, Euskalit 2016</i> Quality Innovation Award, Euskalit 2016		<b>Premio Dato de Oro a la Empresa Solidaria, 2010</b> <i>"Dato de Oro" Award on Corporate Social Responsibility, 2010</i> Prix Dato d'Or à l'Entreprise Solidaire, 2010
	<b>Sello Pyme Innovadora del Ministerio Español de Economía y Competitividad, 2016</b> <i>Innovative SME Stamp from the Spanish Ministry of Economy and Competitiveness, 2016</i> Label de la PME Innovatrice du Ministère Espagnole de l'Economie et de Compétitivité, 2016		<b>Premio Europeo a la Mejor Práctica de Innovación, Foro EFQM 2010</b> <i>European Award to the Best Practice in Innovation, by the EFQM Forum, 2010</i> Prix Européen à la Meilleure Pratique d'Innovation, Forum EFQM 2010
	<b>Premio Juan José Azurmendi a la Trayectoria Empresarial, 2014</b> <i>Employers Federation Award for a Lifelong Entrepreneurial Achievement, 2014</i> Prix Juan José Azurmendi à la Trajectoire Entrepreneuriale, 2014		<b>Premio Finalista a la Excelencia Industrial por IESE (España), INSEAD (Francia) y WHU (Alemania), 2010</b> <i>Industrial Excellence Finalist Award by IESE (Spain), INSEAD (France) and WHU (Germany) Business Schools, 2010</i> Prix finaliste à l'Excellence Industrielle attribué par IESE (Espagne), INSEAD (France) et WHU (Allemagne), 2010
	<b>Premio Lazarraga, 2014</b> <i>Basque Language Award, 2014</i> Prix de la Langue Basque, 2014		<b>Premio Gran Emprendedor, 2010</b> <i>Great Entrepreneur Award for the Founder and Chairman of EGA Master, 2010</i> Prix Grand Entrepreneur, 2010
	<b>OHSAS 18001, 2014</b> <i>OHSAS 18001, 2014</i> OHSAS 18001, 2014		<b>Premio I+D+i en Herramientas de Seguridad, 2010</b> <i>R&amp;D Award for Safety Tools, 2010</i> Prix R&D+i pour les Outils de Sécurité, 2010
	<b>Certificado Bai Euskarari, 2014</b> <i>Linguistic Certification, 2014</i> Certification Linguistique, 2014		<b>Premio a la Internacionalización de la Cámara de Comercio de Álava, 2013</b> <i>Internationalization Award, Chamber of Commerce, 2013</i> Prix à l'Internationalisation de la Chambre de Commerce d'Alava, 2013
	<b>Premio a la Internacionalización de IE Business School e Iberinform, 2013</b> <i>International Business Award 2013 by IE Business School, 2013</i> Prix à l'Internationalisation de IE Business School et Iberinform, 2013		<b>Premio Human a la Estrategia Basada en Personas, 2009</b> <i>Human Award for its Strategy Based on People, 2009</i> Prix Human pour la Stratégie Basée sur les Personnes, 2009





**Premio ICIL a la Excelencia Logística, 2009**  
 ICIL Award to Excellence in Logistics, 2009  
 Prix ICIL à l'Excellence en Logistique, 2009



**Premio a la Mejor Idea en Herramientas del Club de Inventores Españoles, 2007**  
 Best Tool Award by "Spanish Inventor's Club", 2007  
 Prix à la Meilleure Idée en Outillage du Club des Inventeurs Espagnols, 2007



**Premio Finalista a la Mejor Web Corporativa, 2009**  
 Finalist Award to the Best Company Website, March 2009  
 Prix Finaliste au Meilleur Site Web Corporatif, 2009



**Medalla de Oro a la Calidad de la Oficina Nacional de la Normalización de Cuba, 2006**  
 Gold Medal, National Office of Standards and Normalization of Cuba 2006  
 Médaille d'Or à la Qualité du Bureau National de la Normalisation de Cuba, 2006



**ISO 9001:2008, 2009**  
 ISO 9001:2008, 2009  
 ISO 9001-2008, 2009



**Premio al Mejor Diseño de la Oficina Nacional de Diseño Industrial de Cuba a la Llave Vasca, 2006**  
 Best Design Award, National Office of Industrial Design of Cuba, 2006  
 Prix du Meilleur Dessin du Bureau National de Dessin Industriel de Cuba pour la Clé Basque, 2006



**Premio Príncipe Felipe a la Excelencia en Competitividad Empresarial, 2008**  
 Príncipe Felipe Award to Corporate Excellence in Competitiveness, 2008  
 Prix Príncipe Felipe à l'Excellence en Compétitivité Entrepreneuriale, 2008



**Premio Finalista Príncipe Felipe a la Excelencia Empresarial, 2005**  
 Prince Felipe Finalist Award to Corporate Excellence, 2005  
 Prix Finaliste Príncipe Felipe à l'Excellence Industrielle, 2005



**Premio Finalista Príncipe Felipe a la Excelencia Empresarial en Internacionalización, 2008**  
 Príncipe Felipe Finalist Award to Corporate Excellence in Internationalization, 2008  
 Prix Finaliste Príncipe Felipe a l'Excellence Entreprise en Internationalisation, 2008



**Q de Plata EFQM, 2005**  
 EFQM Silver Q Award, 2005  
 Q d'Argent EFQM, 2005



**Premio Toribio Echevarría de Internacionalización, 2008**  
 Toribio Echevarría Export Award, 2008  
 Prix Toribio Echevarría de l'Internationalisation, 2008



**Premio ARGILAN "Empresa y Empleo en Igualdad", 2005**  
 ARGILAN Award for Gender Equality at the Work Place, 2005  
 Prix ARGILAN "Entreprise et Emploi en Egalité", 2005



**Medalla de Oro al Diseño por la Oficina Nacional de la Normalización de Cuba, 2008**  
 Gold Medal by the Cuban Office of Normalization, 2008  
 Médaille d'Or au Design par le Bureau National de la Normalisation de Cuba, 2008



**5 Medallas en el Salón Internacional de la Invención de París, "Concours Lepine", París 2004**  
 5 Medals received at the International Invention Competition in Paris, "Concours Lepine" 2004  
 5 Médailles au Salon International de l'Invention de Paris, "Concours Lepine", Paris 2004



**Q de Plata EFQM, 2008**  
 EFQM Silver Q Award, 2008  
 Q d'Argent EFQM, 2008



**Joven Empresario del Año, 2003**  
 Young Businessman Award, 2003  
 Jeune Entrepreneur de l'Année, 2003



**Premio Finalista Dato de Oro a la Empresa Solidaria de Álava, 2008**  
 "Dato de Oro" Finalist Award on Corporate Social Responsibility, 2008  
 Finaliste Dato d'Or à l'Entreprise Solidaire d'Álava, 2008



**Premio Especial de la Unión Francesa de Inventores, 2003**  
 Special Prize of French Inventor Association, 2003  
 Prix Spécial de l'Union Française des Inventeurs, 2003



**La Llave Alavesa de EGA Master elegida para la Exposición "La Utilidad del Diseño" del Círculo de Bellas Artes, 2008**  
 The Fine Arts Circle of Spain chooses the Basque Wrench for its "Usefulness of Design" Exhibition 2008  
 La Clé Basque d'EGA Master élue pour l'exposition « l'Utilité du Dessin » du Cercle des Beaux Arts, 2008



**Diploma de Ekoskan, 2003**  
 Ekoskan Diploma 2003  
 Diplôme d'Ekoskan, 2003



**Medalla de Plata del Mundial de la Invención e Innovación, París 2003**  
 Silver Medal at the World Congress of Innovation and Invention, Paris 2003  
 Médaille d'argent au Mondial de l'invention et de l'innovation, Paris 2003



**Premio a la Integración Profesional de los Jóvenes de la Fundación Novia Salcedo, 2008**  
 Excellence Award to the Professional Integration of Young People by Novia Salcedo Foundation, 2008  
 Prix à l'Intégration Professionnelle des Jeunes de la Fondation Novia Salcedo, 2008



**ISO 9001:2000, 2003**  
 ISO 9001:2000, 2003  
 ISO 9001-2000, 2003



**Premio Mejor Producto del Año a la Mastergrip, 2007**  
 Best Product Award for Mastergrip, 2007  
 Prix du Meilleur Produit de l'Année à la Mastergrip, 2007



**Premio a la Exportación, 2002**  
 Export Award of Chamber of Commerce, 2002  
 Prix à l'Exportation, 2002



**Premio al Mejor Diseño de la Oficina Nacional de Diseño Industrial de Cuba, 2007**  
 Best Design Award National Office of Industrial Design of Cuba, 2007  
 Prix au Meilleur Design du Bureau National du Design Industriel de Cuba, 2007



**Diploma de Excelencia EFQM, 2002**  
 EFQM Excellence Diploma, 2002  
 Diplôme d'Excellence EFQM, 2002



**ISO 14001:2004, 2007**  
 ISO 14001:2004, 2007  
 ISO 14001-2004, 2007



**Premio a la Innovación Metalmaq, 2001**  
 Innovation Award at Metalmaq, Lisbon 2001  
 Prix à l'innovation Metalmaq, 2001



**5 Medallas obtenidas en el Salón Internacional de la Invención de París, "Concours Lepine", París 2007**  
 5 Medals received at the International Invention Competition in Paris, "Concours Lepine" April 2007  
 5 Médailles obtenues au Salon International de l'Invention de Paris, "Concours Lepine", Paris 2007



**Trofeo Internacional a la Calidad, París 1998**  
 International Quality Award, Paris 1998  
 Trophée International à la Qualité, Paris 1998



**Premio a la Calidad, otorgado por el Ministerio de la Construcción de Cuba, 2007**  
 Quality Award, Ministry of Construction of Cuba, 2007  
 Prix à la Qualité, attribué par le Ministère de la Construction de Cuba, 2007



**Empresa Alavesa del Año, 1998**  
 Company of the Year, 1998  
 Entreprise de l'Année 1998 en Alava



# Q

to the  
Management  
Quality

**Applus<sup>+</sup>**



## CERTIFICATE

No. **AS-0004/21**

**LGA Technological Center, S.A. (Applus+)**  
certifies that the Anti-bribery Management Systems of the organization:

**EGA MASTER, S.L.**

C/ Zorrolleta 11, Poligono Industrial Jundiz,  
01015, Vitoria

For the following activities of:  
Conception, design, manufacturing, control, marketing and after-sales service of tools.

**is in accordance with the requirements of the standard UNE-ISO 37001:2017**

INITIAL CERTIFICATION DATE: 28/05/2021  
THIS CERTIFICATE IS VALID UNTIL: 27/05/2024

General Director  
Applus+ Certification B.U.



Xavier Ruiz Peña

Technical Director  
Applus+ Certification B.U.



Cristina Bachiller Martínez

This certificate will be regarded as valid provided that all the contract conditions for which it is part of were fulfilled  
LGA Technological Center, S.A. (Applus+) Campus U.A.B., Ronda de la Font del Camé s/n, 08193 Bellaterra, Barcelona.

**tüv  
CERT**

## CERTIFICADO

**CERTIFICADO**

La Entidad Certificadora TÜV CERT de TÜV Anlagentechnik GmbH certifica, conforme al procedimiento TÜV CERT, que la empresa

**CERTIFICATE**

The TÜV CERT Certification Body of TÜV Anlagentechnik GmbH hereby certifies in accordance with TÜV CERT procedures that

**CERTIFICAT**

L'Organisme de certification TÜV CERT de la TÜV Anlagentechnik GmbH certifie conformément à la procédure TÜV CERT que la société

**ZERTIFIKAT**

Die TÜV CERT-Zertifizierungsstelle der TÜV Anlagentechnik GmbH bescheinigt gemäß TÜV CERT Verfahren, daß das Unternehmen

**EGA MASTER**  
Zorrolleta, 11 - Polig. Ind. Jündiz  
E-01015 VITORIA-GASTEIZ

ha implantado y aplica un Sistema de Calidad para el área Concepción, diseño, fabricación, control, comercialización y servicio postventa de herramientas

has established and applies a quality system for Conception, design, manufacturing, control, marketing and after-sales service of tools

a établi et entretient un système de qualité pour le domaine de validité suivant Conception, dessin, fabrication, contrôle, commercialisation et service après-vente d'outillage

für den Geltungsbereich Konzept, Entwurf, Herstellung, Kontrolle, Marketing und Kundendienst von Werkzeugen ein Qualitätssicherungssystem eingeführt hat und anwendet

Mediante auditoría realizada, con nº de informe 98046 se verificó el cumplimiento de las exigencias recogidas en la norma

An audit was performed. Report Number 98046. Proof has been furnished that the requirements according to

Par l'audit de qualité consigné dans le rapport n° 98046 s'est vérifié l'accomplissement aux exigences de la norme

Durch ein Audit, Bericht Nr. 98046 wurde der Nachweis erbracht, daß die Forderungen der

**DIN EN ISO 9001:2015**

are fulfilled. a été démontré. erfüllt sind.

Este certificado es válido hasta **2021-02-28**  
Nº de registro de certificado **01 100 98046**



Deutsche  
Akkreditierungsstelle  
D-ZM-16031-04-00



TÜV Rheinland Cert GmbH  
Am Grauen Stein 51109 Köln

**tüv  
CERT**

## CERTIFICADO

**CERTIFICADO**

La Entidad Certificadora TÜV CERT de TÜV Anlagentechnik GmbH certifica, conforme al procedimiento TÜV CERT, que la empresa

**CERTIFICATE**

The TÜV CERT Certification Body of TÜV Anlagentechnik GmbH hereby certifies in accordance with TÜV CERT procedures that

**CERTIFICAT**

L'Organisme de certification TÜV CERT de la TÜV Anlagentechnik GmbH certifie conformément à la procédure TÜV CERT que la société

**ZERTIFIKAT**

Die TÜV CERT-Zertifizierungsstelle der TÜV Anlagentechnik GmbH bescheinigt gemäß TÜV CERT Verfahren, daß das Unternehmen

**EGA MASTER**  
Zorrolleta, 11 - Polig. Ind. Jündiz  
E-01015 VITORIA-GASTEIZ

ha implantado y aplica un Sistema de Calidad para el área Concepción, diseño, fabricación, control, comercialización y servicio postventa de herramientas

has established and applies a quality system for Conception, design, manufacturing, control, marketing and after-sales service of tools

a établi et entretient un système de qualité pour le domaine de validité suivant Conception, dessin, fabrication, contrôle, commercialisation et service après-vente d'outillage

für den Geltungsbereich Konzept, Entwurf, Herstellung, Kontrolle, Marketing und Kundendienst von Werkzeugen ein Qualitätssicherungssystem eingeführt hat und anwendet

Mediante auditoría realizada, con nº de informe 079648 se verificó el cumplimiento de las exigencias recogidas en la norma

An audit was performed. Report Number 079648. Proof has been furnished that the requirements according to

Par l'audit de qualité consigné dans le rapport n° 079648 s'est vérifié l'accomplissement aux exigences de la norme

Durch ein Audit, Bericht Nr. 079648 wurde der Nachweis erbracht, daß die Forderungen der

**ISO 14001:2015**

are fulfilled. a été démontré. erfüllt sind.

Este certificado es válido hasta **2021-05-28**  
Nº de registro de certificado **01 104 079648**



Deutsche  
Akkreditierungsstelle  
D-ZM-16031-04-00



TÜV Rheinland Cert GmbH  
Am Grauen Stein 51109 Köln

Los códigos, parámetros técnicos, dimensiones y características indicados en este catálogo son meramente orientativos y EGA Master se reserva el derecho de modificarlos cuando estime conveniente, sin previo aviso.

The codes, technical parameters, dimensions and characteristics indicated in the catalogue are merely for general guidance. EGA Master reserves the right to modify them as considered necessary for improving the performance and safety of the tool.

Les codes, paramètres techniques, dimensions et caractéristiques indiqués dans le catalogue sont simplement indicatifs et EGA Master se réserve le droit de les modifier à tout moment, sans avertissement préalable.

Die im Katalog angegebenen Artikel-Nummern, technische Parameter, und Eigenschaften stellen nur eine Orientierungshilfe dar. EGA Master behält sich das Recht vor diese zu modifizieren, sofern dies zur Weiterentwicklung und Sicherheit der Werkzeuge notwendig ist.

I codici, parametri tecnici, le dimensioni e le caratteristiche indicati nel catalogo sono semplicemente a titolo indicativo. EGA Master si riserva il diritto di cambiare quando lo ritiene opportuno, senza alcun preavviso.

Os códigos, parámetros técnicos, dimensões e características indicadas neste catálogo são meramente orientativos e a Ega Master reserva-se o direito de modificá-los quando necessário e conveniente, sem aviso prévio.

Коды, технические параметры размеры и ширины отмечены в каталоге просто для общей информации. EGA Master оставляет право изменять их для улучшения инструмента.

# EGA Master

## ART IN INNOVATION

BE SAFE...BE EFFICIENT

# Building a safer world



Las 100 marcas  
más renombradas  
Top 100 leading  
brands of Spain  
Les 100 marques  
les plus Renommées

